

Product Description

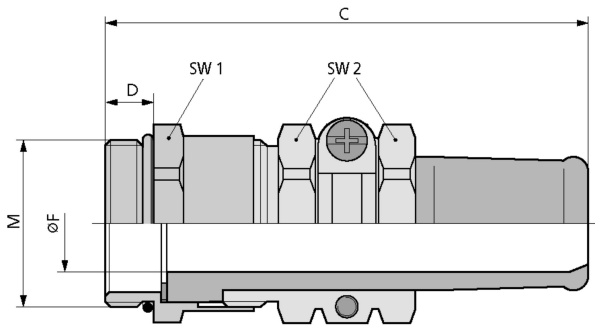

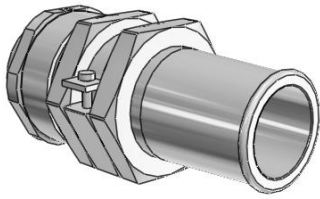

Technical Data

ATN	52106550
M	M 32x1,5
FMIN	23
FMAX	25
F	23
SW1	40
A1	42.5
SW2	41
A2	47
C	90.5
D	8
MATERIAL	Messing vernickelt