

Product Description

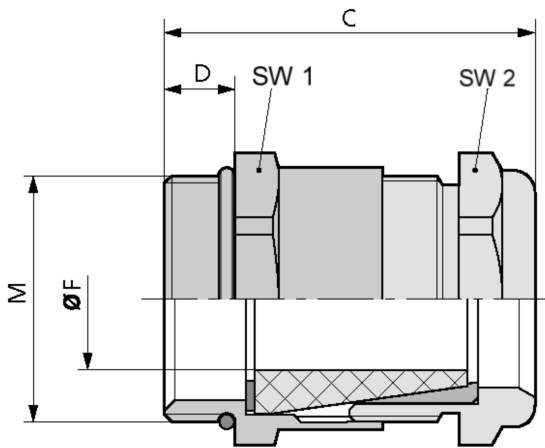

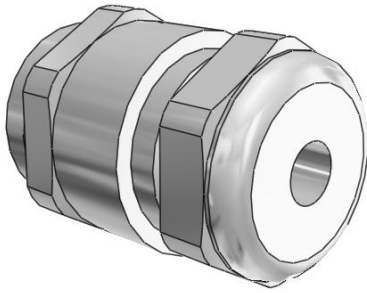

Technical Data

ATN	52105290
M	M 16x1,5
FMIN	4.5
FMAX	6.8
F	4.5
SW1	18
A1	19.8
SW2	17
A2	18.8
C	26.5
D	5
MATERIAL	Messing vernickelt