

Product Description

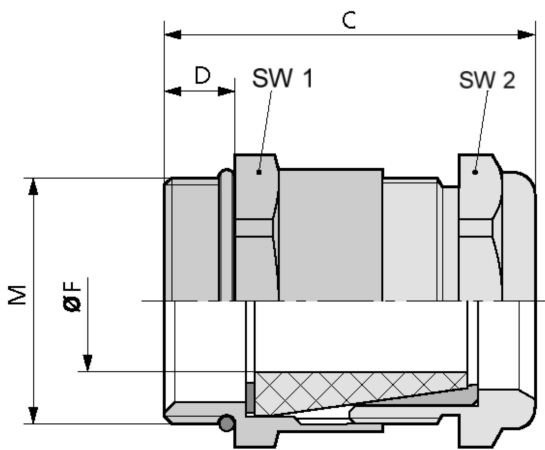

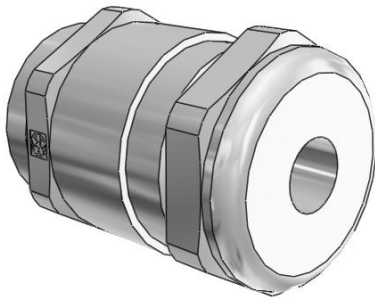

Technical Data

ATN	52105320
M	M 20x1,5
FMIN	6.5
FMAX	8.8
F	6.5
SW1	22
A1	24.4
SW2	22
A2	24.4
C	32.5
D	6
MATERIAL	Messing vernickelt