

Product Description

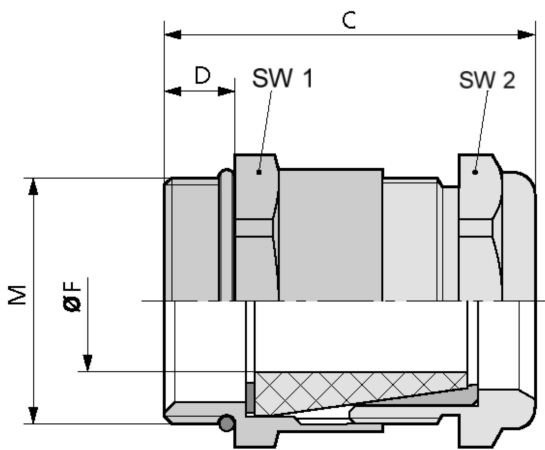

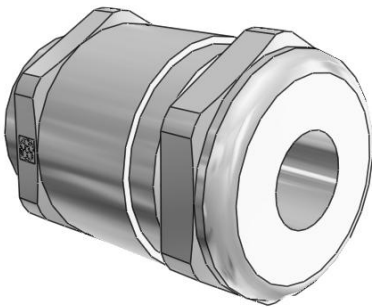

**Technical Data**

ATN	52105340
M	M 20x1,5
FMIN	9
FMAX	10.8
F	9
SW1	24
A1	26.7
SW2	24
A2	26.7
C	34.5
D	6
MATERIAL	Messing vernickelt