

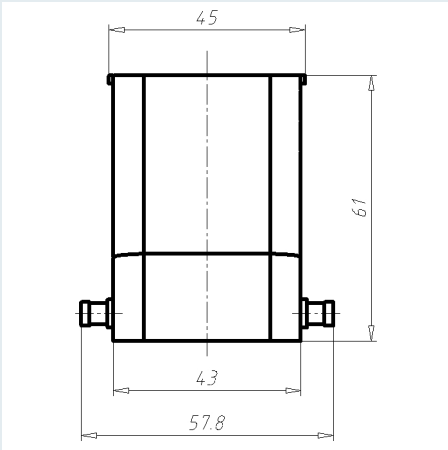

Gehäuse EPIC® H-B 24 TG

PDF DATASHEET

© 1992 - 2010 CADENAS GmbH

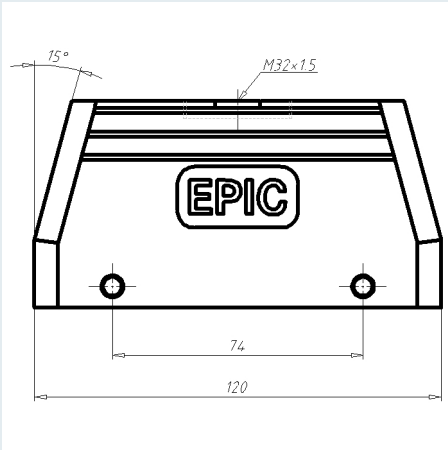
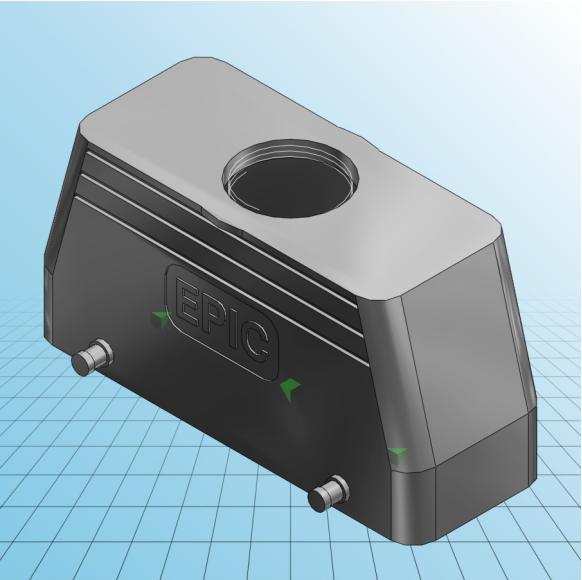



Gehäuse EPIC® H-B 24 TG

PDF DATASHEET

© 1992 - 2010 CADENAS GmbH

IDNR (Identnummer)	
ATN (Artikelnummer)	19111000
MD (Materialbezeichnung)	EPIC H-B 24 TG M32
WG (Gewicht / G)	244
VPE (Verpackung [Stück])	5
PG (Gewinde PG)	-
M (Gewinde metrisch)	M32