

Datenblatt | Artikelnummer: 270-564

3-Leiter-Initiatoreinspeiseklemme; Interne Brückung, 9 A; mit farbig bedruckten Leitereinführungen; 2,5 mm²; CAGE CLAMP®

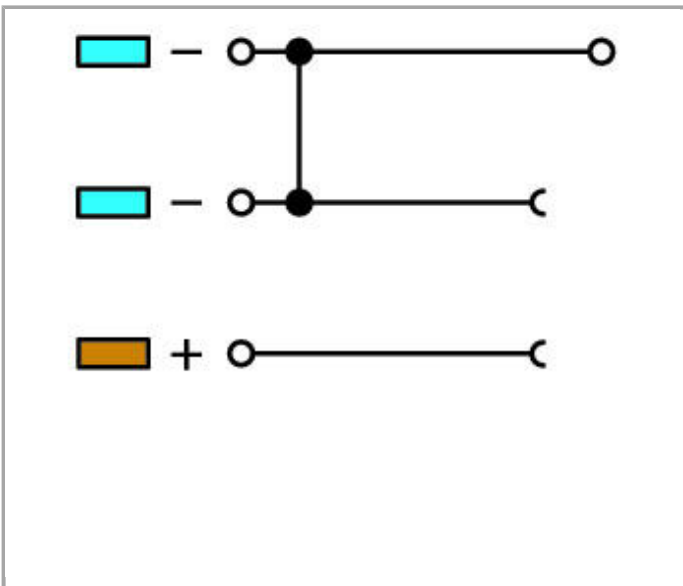

www.wago.com/270-564

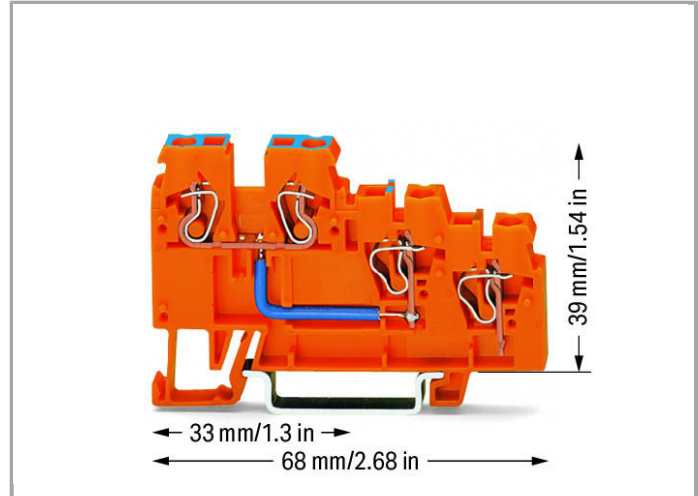
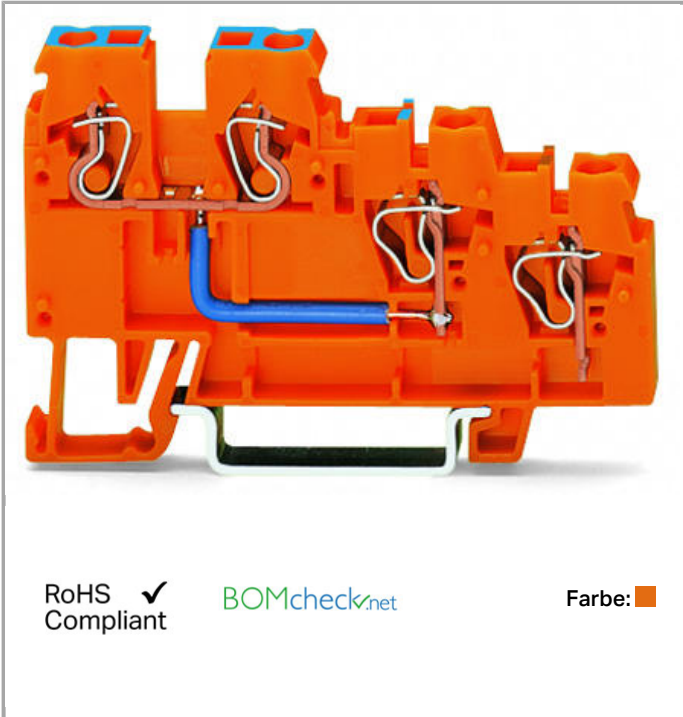

Daten
Elektrische Daten

Bemessungsdaten gemäß IEC/EN 60664-1

Bemessungsspannung (III / 3)	250 V
Bemessungsstoßspannung (III / 3)	4 kV
Bemessungsstrom	18 A
Legende Bemessungsdaten	(III / 3) \triangleq Überspannungskategorie III / Verschmutzungsgrad 3

Anschlussdaten

Anschlusstechnik	CAGE CLAMP®
Betätigungsart	Betätigungswerkzeug
Anschließbare Leiterwerkstoffe	Kupfer Aluminium
Eindrähtiger Leiter	0,08 ... 2,5 mm ² / 28 ... 12 AWG
Feindrähtiger Leiter	0,08 ... 2,5 mm ² / 28 ... 12 AWG
Abisolierlänge	6 ... 7 mm / 0.24 ... 0.28 inch
Gesamte Anzahl der Klemmstellen	4
Gesamte Anzahl der Potentiale	2
Anzahl der Ebenen	3
Verdrahtungsart	Frontverdrahtung

Geometrische Daten

Breite	5 mm / 0.197 inch
Höhe ab Oberkante Tragschiene	39 mm / 1.535 inch
Tiefe	68 mm / 2.677 inch

Mechanische Daten

Bauform	horizontale Bauform
Montageart	Tragschiene 35
Beschriftungsebene	Seitliche Beschriftung

Werkstoffdaten

Farbe	orange
Brandlast	1.372 MJ
Gewicht	9.29 g

Kaufmännische Daten

Ursprungsland	CN
GTIN	4045454193768
Zolltarifnummer	85369010000

Produktgruppe	1 (Reihenklemmen)
eCl@ss 9.0	27-14-11-28
eCl@ss 8.0	27-14-11-28
ETIM 6.0	EC000900
ETIM 5.0	EC000900

Zulassungen / Zertifikate

Länderspezifische Zulassungen

Logo	Zulassung	Zertifikatsname
	CCA DEKRA Certification B.V.	NTR NL 6828
	CCA DEKRA Certification B.V.	2143311.03
	CSA DEKRA Certification B.V.	1565649

Passende Produkte



Abschlussplatte

	Art-Nr.: 270-321 Abschluss- und Zwischenplatte; 1 mm dick; für Dreistockklemmen	www.wago.com/270-321
--	---	--















Werkzeug

















	Art-Nr.: 210-657 Betätigungswerkzeug mit teilisoliertem Schaft; Klinge (3,5 x 0,5) mm; kurz	www.wago.com/210-657
	Art-Nr.: 210-720 Betätigungswerkzeug mit teilisoliertem Schaft; Typ 2, Klinge (3,5 x 0,5) mm	www.wago.com/210-720

Isolierungs-Stopp

	Art-Nr.: 280-470 Isolierungsstopp; 0,08 - 0,2 mm ² "e" (0,14 mm ² "f"); 5 Stück / Strang	www.wago.com/280-470
	Art-Nr.: 280-471 Isolierungsstopp; 0,25 - 0,5 mm ² ; 5 Stück / Strang	www.wago.com/280-471
	Art-Nr.: 280-472 Isolierungsstopp; 0,75 - 1 mm ² ; 5 Stück / Strang	www.wago.com/280-472

Beschriftungsmaterial

	Art-Nr.: 2009-115 WMB-Inline; für smartPRINTER; auf Rolle; dehnbar 5 - 5,2 mm; unbedruckt; aufrastbar	www.wago.com/2009-115
	Art-Nr.: 2009-115/000-002 WMB-Inline; für smartPRINTER; auf Rolle; dehnbar 5 - 5,2 mm; unbedruckt; aufrastbar	www.wago.com/2009-115/000-002
	Art-Nr.: 2009-115/000-006 WMB-Inline; für smartPRINTER; auf Rolle; dehnbar 5 - 5,2 mm; unbedruckt; aufrastbar	www.wago.com/2009-115/000-006
	Art-Nr.: 2009-115/000-007 WMB-Inline; für smartPRINTER; auf Rolle; dehnbar 5 - 5,2 mm; unbedruckt; aufrastbar	www.wago.com/2009-115/000-007
	Art-Nr.: 2009-115/000-012 WMB-Inline; für smartPRINTER; auf Rolle; dehnbar 5 - 5,2 mm; unbedruckt; aufrastbar	www.wago.com/2009-115/000-012
	Art-Nr.: 2009-115/000-017 WMB-Inline; für smartPRINTER; auf Rolle; dehnbar 5 - 5,2 mm; unbedruckt; aufrastbar	www.wago.com/2009-115/000-017
	Art-Nr.: 2009-115/000-023 WMB-Inline; für smartPRINTER; auf Rolle; dehnbar 5 - 5,2 mm; unbedruckt; aufrastbar	www.wago.com/2009-115/000-023
	Art-Nr.: 2009-115/000-024 WMB-Inline; für smartPRINTER; auf Rolle; dehnbar 5 - 5,2 mm; unbedruckt; aufrastbar	www.wago.com/2009-115/000-024
	Art-Nr.: 2009-145 Mini-WSB Inline; für smartPRINTER; auf Rolle; dehnbar 5 - 5,2 mm; unbedruckt; aufrastbar	www.wago.com/2009-145
	Art-Nr.: 2009-145/000-002 Mini-WSB Inline; für smartPRINTER; auf Rolle; dehnbar 5 - 5,2 mm; unbedruckt; aufrastbar	www.wago.com/2009-145/000-002
	Art-Nr.: 2009-145/000-005 Mini-WSB Inline; für smartPRINTER; auf Rolle; dehnbar 5 - 5,2 mm; unbedruckt; aufrastbar	www.wago.com/2009-145/000-005
	Art-Nr.: 2009-145/000-006 Mini-WSB Inline; für smartPRINTER; auf Rolle; dehnbar 5 - 5,2 mm; unbedruckt; aufrastbar	www.wago.com/2009-145/000-006
	Art-Nr.: 2009-145/000-007 Mini-WSB Inline; für smartPRINTER; auf Rolle; dehnbar 5 - 5,2 mm; unbedruckt; aufrastbar	www.wago.com/2009-145/000-007
	Art-Nr.: 2009-145/000-012 Mini-WSB Inline; für smartPRINTER; auf Rolle; dehnbar 5 - 5,2 mm; unbedruckt; aufrastbar	www.wago.com/2009-145/000-012
	Art-Nr.: 2009-145/000-023 Mini-WSB Inline; für smartPRINTER; auf Rolle; dehnbar 5 - 5,2 mm; unbedruckt; aufrastbar	www.wago.com/2009-145/000-023

	Art-Nr.: 2009-145/000-024 Mini-WSB Inline; auf Rolle; dehnbar 5 - 5,2 mm; unbedruckt; aufrastbar	www.wago.com/2009-145/000-024
	Art-Nr.: 248-501 Mini-WSB-Schnellbeschriftungssystem; unbedruckt; Schildchenbreite 5 mm; 10 Streifen à 10 Schilder pro Karte	www.wago.com/248-501
	Art-Nr.: 248-501/000-002 Mini-WSB-Beschriftungskarte; als Karte; nicht dehnbar; unbedruckt; aufrastbar	www.wago.com/248-501/000-002
	Art-Nr.: 248-501/000-005 Mini-WSB-Beschriftungskarte; als Karte; unbedruckt; aufrastbar	www.wago.com/248-501/000-005
	Art-Nr.: 248-501/000-006 Mini-WSB-Beschriftungskarte; als Karte; nicht dehnbar; unbedruckt; aufrastbar	www.wago.com/248-501/000-006
	Art-Nr.: 248-501/000-007 Mini-WSB-Beschriftungskarte; als Karte; nicht dehnbar; unbedruckt; aufrastbar	www.wago.com/248-501/000-007
	Art-Nr.: 248-501/000-012 Mini-WSB-Beschriftungskarte; als Karte; nicht dehnbar; unbedruckt; aufrastbar	www.wago.com/248-501/000-012
	Art-Nr.: 248-501/000-017 Mini-WSB-Beschriftungskarte; als Karte; nicht dehnbar; unbedruckt; aufrastbar	www.wago.com/248-501/000-017
	Art-Nr.: 248-501/000-023 Mini-WSB-Beschriftungskarte; als Karte; nicht dehnbar; unbedruckt; aufrastbar	www.wago.com/248-501/000-023
	Art-Nr.: 248-501/000-024 Mini-WSB-Beschriftungskarte; als Karte; nicht dehnbar; unbedruckt; aufrastbar	www.wago.com/248-501/000-024
	Art-Nr.: 709-177 Beschriftungsstreifen; auf Rolle; 7,5 mm breit; nicht dehnbar; unbedruckt; aufrastbar	www.wago.com/709-177
	Art-Nr.: 709-178 Beschriftungsstreifen; auf Rolle; 7,5 mm breit; nicht dehnbar; unbedruckt; aufrastbar	www.wago.com/709-178
	Art-Nr.: 709-196 Beschriftungsstreifen; für Laserdrucker	www.wago.com/709-196
	Art-Nr.: 793-501 WMB-Beschriftungskarte; als Karte; nicht dehnbar; unbedruckt; aufrastbar	www.wago.com/793-501
	Art-Nr.: 793-501/000-002 WMB-Beschriftungskarte; als Karte; nicht dehnbar; unbedruckt; aufrastbar	www.wago.com/793-501/000-002
	Art-Nr.: 793-501/000-005 WMB-Beschriftungskarte; als Karte; nicht dehnbar; unbedruckt; aufrastbar	www.wago.com/793-501/000-005



Art-Nr.: 793-501/000-006
WMB-Beschriftungskarte; als Karte; nicht dehnbar; unbedruckt; aufrastbar

www.wago.com/793-501/000-006



Art-Nr.: 793-501/000-007
WMB-Beschriftungskarte; als Karte; nicht dehnbar; unbedruckt; aufrastbar

www.wago.com/793-501/000-007



Art-Nr.: 793-501/000-012
WMB-Beschriftungskarte; als Karte; nicht dehnbar; unbedruckt; aufrastbar

www.wago.com/793-501/000-012



Art-Nr.: 793-501/000-017
WMB-Beschriftungskarte; als Karte; nicht dehnbar; unbedruckt; aufrastbar

www.wago.com/793-501/000-017



Art-Nr.: 793-501/000-023
WMB-Beschriftungskarte; als Karte; nicht dehnbar; unbedruckt; aufrastbar

www.wago.com/793-501/000-023



Art-Nr.: 793-501/000-024
WMB-Beschriftungskarte; als Karte; nicht dehnbar; unbedruckt; aufrastbar

www.wago.com/793-501/000-024



Art-Nr.: 793-5501
WMB-Beschriftungskarte; als Karte; für Klemmenbreite 5 - 17,5 mm; dehnbar 5 - 5,2 mm; unbedruckt; aufrastbar

www.wago.com/793-5501



Art-Nr.: 793-5501/000-002
WMB-Beschriftungskarte; als Karte; für Klemmenbreite 5 - 17,5 mm; dehnbar 5 - 5,2 mm; unbedruckt; aufrastbar

www.wago.com/793-5501/000-002



Art-Nr.: 793-5501/000-005
WMB-Beschriftungskarte; als Karte; dehnbar 5 - 5,2 mm; unbedruckt; aufrastbar

www.wago.com/793-5501/000-005



Art-Nr.: 793-5501/000-006
WMB-Beschriftungskarte; als Karte; dehnbar 5 - 5,2 mm; unbedruckt; aufrastbar

www.wago.com/793-5501/000-006



Art-Nr.: 793-5501/000-007
WMB-Beschriftungskarte; als Karte; dehnbar 5 - 5,2 mm; unbedruckt; aufrastbar

www.wago.com/793-5501/000-007



Art-Nr.: 793-5501/000-012
WMB-Beschriftungskarte; als Karte; dehnbar 5 - 5,2 mm; unbedruckt; aufrastbar

www.wago.com/793-5501/000-012



Art-Nr.: 793-5501/000-017
WMB-Beschriftungskarte; als Karte; dehnbar 5 - 5,2 mm; unbedruckt; aufrastbar

www.wago.com/793-5501/000-017



Art-Nr.: 793-5501/000-023
WMB-Beschriftungskarte; als Karte; dehnbar 5 - 5,2 mm; unbedruckt; aufrastbar















www.wago.com/793-5501/000-023





Art-Nr.: 793-5501/000-024
WMB-Beschriftungskarte; als Karte; dehnbar 5 - 5,2 mm; unbedruckt; aufrastbar









www.wago.com/793-5501/000-024

Brücker

	Art-Nr.: 270-409 Brücker; blank; 9-fach; Nennstrom 18 A	www.wago.com/270-409
	Art-Nr.: 270-417 Brücker; blank; 17-fach; Nennstrom 18 A	www.wago.com/270-417
	Art-Nr.: 270-480 Brücker; blank; 80-fach; Nennstrom 18 A	www.wago.com/270-480
	Art-Nr.: 870-402 Kammbrücker; isoliert; 2-fach; Nennstrom 18 A	www.wago.com/870-402
	Art-Nr.: 870-403 Kammbrücker; isoliert; 3-fach; Nennstrom 18 A	www.wago.com/870-403
	Art-Nr.: 870-404 Kammbrücker; isoliert; 4-fach; Nennstrom 18 A	www.wago.com/870-404
	Art-Nr.: 870-405 Kammbrücker; isoliert; 5-fach; Nennstrom 18 A	www.wago.com/870-405
	Art-Nr.: 870-405/011-000 Vorkonfektionierter Kammbrücker; isoliert; 3-fach (1-3-5); Nennstrom 18 A	www.wago.com/870-405/011-000
	Art-Nr.: 870-406 Kammbrücker; isoliert; 6-fach; Nennstrom 18 A	www.wago.com/870-406
	Art-Nr.: 870-407 Kammbrücker; isoliert; 7-fach; Nennstrom 18 A	www.wago.com/870-407
	Art-Nr.: 870-407/011-000 Vorkonfektionierter Kammbrücker; isoliert; 3-fach (1-3-5); Nennstrom 18 A	www.wago.com/870-407/011-000
	Art-Nr.: 870-408 Kammbrücker; isoliert; 8-fach; Nennstrom 18 A	www.wago.com/870-408
	Art-Nr.: 870-409 Kammbrücker; isoliert; 9-fach; Nennstrom 18 A	www.wago.com/870-409
	Art-Nr.: 870-409/011-000 Vorkonfektionierter Kammbrücker; isoliert; 3-fach (1-3-5); Nennstrom 18 A	www.wago.com/870-409/011-000

Aderendhülse

	Art-Nr.: 216-121 Aderendhülse; Hülse für 0,5 mm ² / AWG 22; ohne Kunststoffkragen; galvanisch verzinkt	www.wago.com/216-121
	Art-Nr.: 216-122 Aderendhülse; Hülse für 0,75 mm ² / AWG 20; ohne Kunststoffkragen; galvanisch verzinkt	www.wago.com/216-122
	Art-Nr.: 216-123 Aderendhülse; Hülse für 1 mm ² / AWG 18; ohne Kunststoffkragen; galvanisch verzinkt	www.wago.com/216-123

	Art-Nr.: 216-124 Aderendhülse; Hülse für 1,5 mm ² / AWG 16; ohne Kunststoffkragen; galvanisch verzinkt	www.wago.com/216-124
	Art-Nr.: 216-131 Aderendhülse; Hülse für 0,25 mm ² / AWG 24; ohne Kunststoffkragen; galvanisch verzinkt	www.wago.com/216-131
	Art-Nr.: 216-132 Aderendhülse; Hülse für 0,34 mm ² / AWG 24; ohne Kunststoffkragen; galvanisch verzinkt	www.wago.com/216-132
	Art-Nr.: 216-221 Aderendhülse; Hülse für 0,5 mm ² / AWG 22; mit Kunststoffkragen; galvanisch verzinkt	www.wago.com/216-221
	Art-Nr.: 216-222 Aderendhülse; Hülse für 0,75 mm ² / AWG 20; mit Kunststoffkragen; galvanisch verzinkt	www.wago.com/216-222
	Art-Nr.: 216-223 Aderendhülse; Hülse für 1 mm ² / AWG 18; mit Kunststoffkragen; galvanisch verzinkt	www.wago.com/216-223
	Art-Nr.: 216-224 Aderendhülse; Hülse für 1,5 mm ² / AWG 16; mit Kunststoffkragen; galvanisch verzinkt	www.wago.com/216-224
	Art-Nr.: 216-321 Aderendhülse; Hülse für 0,25 mm ² / AWG 24; mit Kunststoffkragen; galvanisch verzinkt	www.wago.com/216-321
	Art-Nr.: 216-322 Aderendhülse; Hülse für 0,34 mm ² / AWG 24; mit Kunststoffkragen; galvanisch verzinkt	www.wago.com/216-322

Downloads

Dokumentation

Ausschreibungstext

270-564	Oct 11, 2017	DOC 24,1 kB	Download
---------	--------------	----------------	----------

smartDATA

CAD Daten

3D Download 270-564	URL	Download
---------------------	-----	----------

Änderungen vorbehalten.

WAGO Kontakttechnik GmbH & Co. KG
 Hansastr. 27
 32423 Minden
 Telefon: +49571 887-0
 E-Mail: info.de@wago.com | Web: www.wago.com

Haben Sie Fragen zu unseren Produkten?
 Wir stehen Ihnen telefonisch unter +49 (571) 887-44222 gern zur
 Verfügung.