

Datenblatt | Artikelnummer: 769-176

1-Leiter/1-Pin-Basisklemme; für Tragschiene 35 x 15 und 35 x 7,5; 4 mm²;
CAGE CLAMP®

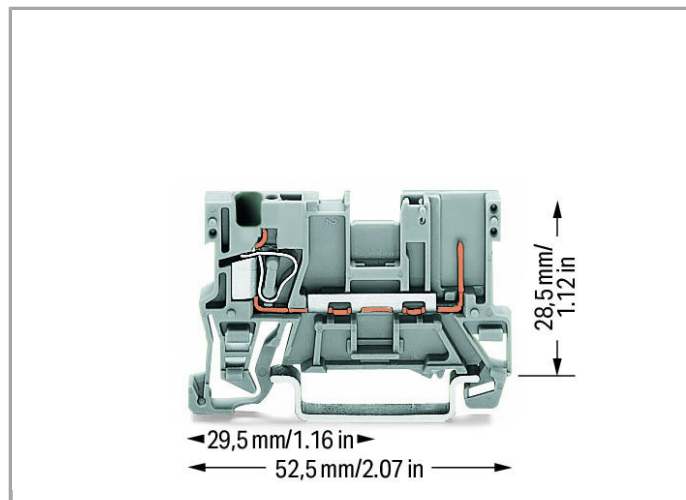

www.wago.com/769-176

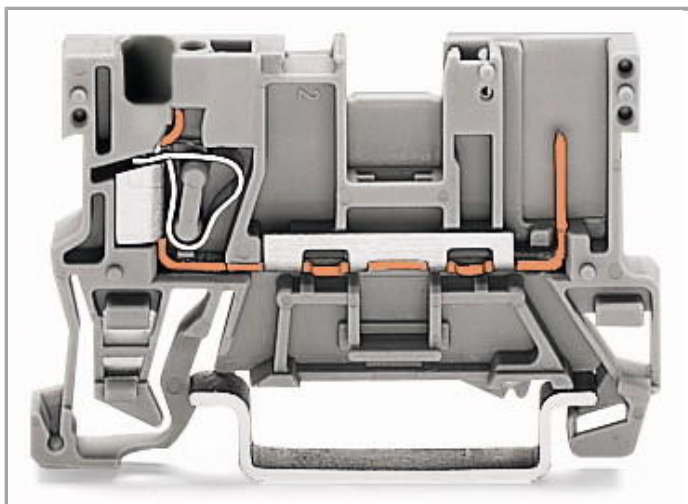

RoHS ✓
Compliant

BOMcheck.net

Farbe: ■

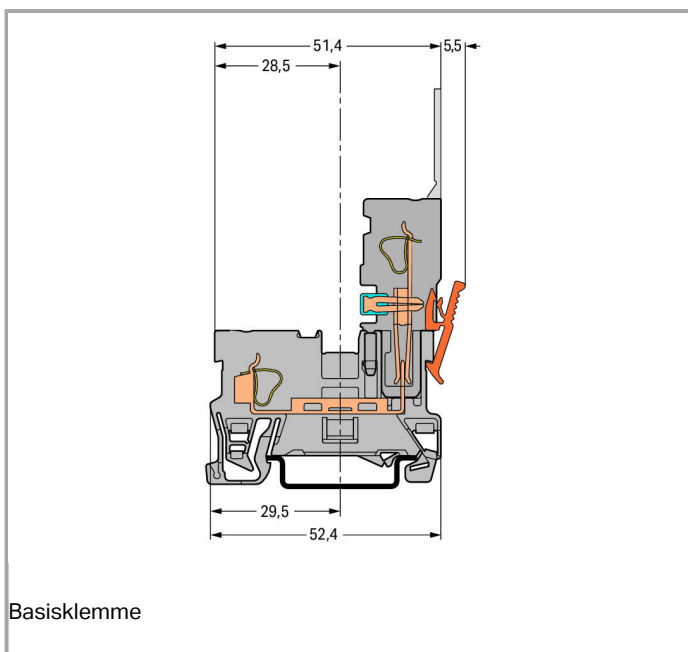

Daten
Elektrische Daten

Bemessungsdaten gemäß IEC/EN 60664-1

Bemessungsspannung (III / 3)	500 V
Bemessungsstoßspannung (III / 3)	6 kV
Bemessungsstrom	32 A
Legende Bemessungsdaten	(III / 3) $\hat{=}$ Überspannungskategorie III / Verschmutzungsgrad 3

Anschlussdaten

Anschlusstechnik	CAGE CLAMP®
Betätigungsart	Betätigungswerkzeug
Anschließbare Leiterwerkstoffe	Kupfer Aluminium
Nennquerschnitt	4 mm ²
Eindrähtiger Leiter	0,08 ... 4 mm ² / 28 ... 12 AWG
Feindrähtiger Leiter	0,08 ... 4 mm ² / 28 ... 12 AWG
Abisolierlänge	8 ... 9 mm / 0.31 ... 0.35 inch
Gesamte Anzahl der Klemmstellen	1
Gesamte Anzahl der Potentiale	1
Anzahl der Ebenen	1
Verdrahtungsart	Frontverdrahtung

Geometrische Daten

Breite	5 mm / 0.197 inch
Höhe ab Oberkante Tragschiene	28,5 mm / 1.122 inch
Tiefe	52,5 mm / 2.067 inch

Mechanische Daten

Bauform	horizontale Bauform
Montageart	Tragschiene 35
Beschriftungsebene	Mittenbeschriftung

Werkstoffdaten

Farbe	grau
Isolierwerkstoff	Polyamid 66 (PA 66)
Brandlast	0.101 MJ
Gewicht	5.27 g



Kaufmännische Daten

Ursprungsland	CN
GTIN	4045454871697



Zolltarifnummer	85366990990
Produktgruppe	18 (X-COM-System)
eCl@ss 9.0	27-14-11-20
eCl@ss 8.0	27-14-11-20
ETIM 6.0	EC000897
ETIM 5.0	EC000897

Zulassungen / Zertifikate

Länderspezifische Zulassungen

Logo	Zulassung	Zertifikatsname
	CCA DEKRA Certification B.V.	NTR NL-7626
	CSA DEKRA Certification B.V.	1101144
	KEMA/KEUR DEKRA Certification B.V.	2190419.01

Schiff Zulassungen

















Logo	Zulassung	Zertifikatsname
	ABS American Bureau of Shipping	14-HG1293677-PDA
	LR Lloyds Register	91/20112 (E9)

















UL-Zulassungen

Logo	Zulassung	Zertifikatsname
	UR Underwriters Laboratories Inc.	E45171
	UR Underwriters Laboratories Inc.	E45172











Passende Produkte

Allgemeines Zubehör







	Art-Nr.: 280-404 Prüfadapter; 5 mm breit; für Prüfstecker 210-137 (Ø 2,3 mm); passend für Klemmen 1,5 mm ² - 4 mm ²	www.wago.com/280-404
	Art-Nr.: 280-418 Prüfsteckermodul; anreihbar; passend zu allen WAGO-Reihenklemmen der Serien 280 und 780 mit Brückerschlitzen in der Stromschiene	www.wago.com/280-418
	Art-Nr.: 280-419 Blindmodul; anreihbar; zum Überspringen von Klemmen	www.wago.com/280-419
	Art-Nr.: 769-438 Pin-Abdeckung; mit Beschriftungsaufnahme für Mini-WSB	www.wago.com/769-438
	Art-Nr.: 769-439 Pin-Abdeckung; mit Beschriftungsaufnahme für Mini-WSB	www.wago.com/769-439
	Art-Nr.: 769-501 1-Leiter-Federleisten-Anfangsmodul; mit integrierter Abschlussplatte; 4 mm ² ; 1-polig	www.wago.com/769-501
	Art-Nr.: 769-501/000-006 1-Leiter-Federleisten-Anfangsmodul; 4 mm ² ; 1-polig	www.wago.com/769-501/000-006
	Art-Nr.: 769-501/000-016 1-Leiter-Federleisten-Anfangsmodul; mit integrierter Abschlussplatte; 4 mm ² ; 1-polig	www.wago.com/769-501/000-016
	Art-Nr.: 769-502 1-Leiter-Federleisten-Mittelmodul; 4 mm ² ; 1-polig	www.wago.com/769-502
	Art-Nr.: 769-502/000-006 1-Leiter-Federleisten-Mittelmodul; 4 mm ² ; 1-polig	www.wago.com/769-502/000-006
	Art-Nr.: 769-502/000-016 1-Leiter-Mittelmodul; kodierbar; brückbar mit Mini-Querbrückern; 1-polig	www.wago.com/769-502/000-016
	Art-Nr.: 769-503 1-Leiter-Federleisten-Endmodul; 4 mm ² ; 1-polig	www.wago.com/769-503
	Art-Nr.: 769-503/000-006 1-Leiter-Endmodul; kodierbar; brückbar mit Mini-Querbrückern; 1-polig	www.wago.com/769-503/000-006
	Art-Nr.: 769-503/000-016 1-Leiter-Endmodul; kodierbar; brückbar mit Mini-Querbrückern; 1-polig	www.wago.com/769-503/000-016
	Art-Nr.: 769-504 2-Leiter-Anfangsmodul; mit integrierter Abschlussplatte; kodierbar; brückbar mit Quer- und Schachtelbrückern; 1-polig	www.wago.com/769-504
	Art-Nr.: 769-504/000-006 2-Leiter-Federleisten-Anfangsmodul; mit integrierter Abschlussplatte; 4 mm ² ; 1-polig	www.wago.com/769-504/000-006















	Art-Nr.: 769-504/000-016 2-Leiter-Anfangsmodul; mit integrierter Abschlussplatte; kodierbar; brückbar mit Quer- und Schachtelbrückern; 1-polig	www.wago.com/769-504/000-016
	Art-Nr.: 769-505 2-Leiter-Mittelmodul; kodierbar; brückbar mit Quer- und Schachtelbrückern; 1-polig	www.wago.com/769-505
	Art-Nr.: 769-505/000-006 2-Leiter-Mittelmodul; kodierbar; brückbar mit Quer- und Schachtelbrückern; 1-polig	www.wago.com/769-505/000-006
	Art-Nr.: 769-505/000-016 2-Leiter-Mittelmodul; kodierbar; brückbar mit Quer- und Schachtelbrückern; 1-polig	www.wago.com/769-505/000-016
	Art-Nr.: 769-506 2-Leiter-Endmodul; kodierbar; brückbar mit Quer- und Schachtelbrückern; 1-polig	www.wago.com/769-506
	Art-Nr.: 769-506/000-006 2-Leiter-Federleisten-Endmodul; 4 mm ² ; 1-polig	www.wago.com/769-506/000-006
	Art-Nr.: 769-506/000-016 2-Leiter-Endmodul; kodierbar; brückbar mit Quer- und Schachtelbrückern; 1-polig	www.wago.com/769-506/000-016
	Art-Nr.: 769-512 1-Leiter-Federleisten-Anfangsmodul; abgewinkelt; 4 mm ² ; 1-polig	www.wago.com/769-512
	Art-Nr.: 769-512/000-006 1-Leiter-Anfangsmodul; abgewinkelt; mit integrierter Abschlussplatte; kodierbar; 1-polig	www.wago.com/769-512/000-006
	Art-Nr.: 769-512/000-016 1-Leiter-Anfangsmodul; abgewinkelt; mit integrierter Abschlussplatte; kodierbar; 1-polig	www.wago.com/769-512/000-016
	Art-Nr.: 769-513 1-Leiter-Federleisten-Mittelmodul; abgewinkelt; 4 mm ² ; 1-polig	www.wago.com/769-513
	Art-Nr.: 769-513/000-006 1-Leiter-Mittelmodul; abgewinkelt; kodierbar; 1-polig	www.wago.com/769-513/000-006
	Art-Nr.: 769-513/000-016 1-Leiter-Mittelmodul; abgewinkelt; kodierbar; 1-polig	www.wago.com/769-513/000-016
	Art-Nr.: 769-515 1-Leiter-Endmodul; abgewinkelt; kodierbar; 1-polig	www.wago.com/769-515
	Art-Nr.: 769-515/000-006 1-Leiter-Endmodul; abgewinkelt; kodierbar; 1-polig	www.wago.com/769-515/000-006
	Art-Nr.: 769-515/000-016 1-Leiter-Endmodul; abgewinkelt; kodierbar; 1-polig	www.wago.com/769-515/000-016

Aderendhülse

	Art-Nr.: 216-101 Aderendhülse; Hülse für 0,5 mm ² / AWG 22; ohne Kunststoffkragen; galvanisch verzinkt	www.wago.com/216-101
	Art-Nr.: 216-102 Aderendhülse; Hülse für 0,75 mm ² / AWG 20; ohne Kunststoffkragen; galvanisch verzinkt	www.wago.com/216-102
	Art-Nr.: 216-103 Aderendhülse; Hülse für 1 mm ² / AWG 18; ohne Kunststoffkragen; galvanisch verzinkt	www.wago.com/216-103
	Art-Nr.: 216-104 Aderendhülse; Hülse für 1,5 mm ² / AWG 16; ohne Kunststoffkragen; galvanisch verzinkt	www.wago.com/216-104
	Art-Nr.: 216-201 Aderendhülse; Hülse für 0,5 mm ² / AWG 22; mit Kunststoffkragen; galvanisch verzinkt	www.wago.com/216-201
	Art-Nr.: 216-202 Aderendhülse; Hülse für 0,75 mm ² / AWG 20; mit Kunststoffkragen; galvanisch verzinkt	www.wago.com/216-202
	Art-Nr.: 216-203 Aderendhülse; Hülse für 1 mm ² / AWG 18; mit Kunststoffkragen; galvanisch verzinkt	www.wago.com/216-203
	Art-Nr.: 216-204 Aderendhülse; Hülse für 1,5 mm ² / AWG 16; mit Kunststoffkragen; galvanisch verzinkt	www.wago.com/216-204
	Art-Nr.: 216-206 Aderendhülse; Hülse für 2,5 mm ² / AWG 14; mit Kunststoffkragen; galvanisch verzinkt	www.wago.com/216-206
	Art-Nr.: 216-301 Aderendhülse; Hülse für 0,25 mm ² / AWG 24; mit Kunststoffkragen; galvanisch verzinkt	www.wago.com/216-301
	Art-Nr.: 216-302 Aderendhülse; Hülse für 0,34 mm ² / AWG 24; mit Kunststoffkragen; galvanisch verzinkt	www.wago.com/216-302

Beschriftungsmaterial

	Art-Nr.: 2009-145 Mini-WSB Inline; für smartPRINTER; auf Rolle; dehnbar 5 - 5,2 mm; unbedruckt; aufrastbar	www.wago.com/2009-145
	Art-Nr.: 2009-145/000-002 Mini-WSB Inline; für smartPRINTER; auf Rolle; dehnbar 5 - 5,2 mm; unbedruckt; aufrastbar	www.wago.com/2009-145/000-002
	Art-Nr.: 2009-145/000-005 Mini-WSB Inline; für smartPRINTER; auf Rolle; dehnbar 5 - 5,2 mm; unbedruckt; aufrastbar	www.wago.com/2009-145/000-005
	Art-Nr.: 2009-145/000-006 Mini-WSB Inline; für smartPRINTER; auf Rolle; dehnbar 5 - 5,2 mm; unbedruckt; aufrastbar	www.wago.com/2009-145/000-006
	Art-Nr.: 2009-145/000-007 Mini-WSB Inline; für smartPRINTER; auf Rolle; dehnbar 5 - 5,2 mm; unbedruckt; aufrastbar	www.wago.com/2009-145/000-007
	Art-Nr.: 2009-145/000-012 Mini-WSB Inline; für smartPRINTER; auf Rolle; dehnbar 5 - 5,2 mm; unbedruckt; aufrastbar	www.wago.com/2009-145/000-012

	Art-Nr.: 2009-145/000-023 Mini-WSB Inline; für smartPRINTER; auf Rolle; dehnbar 5 - 5,2 mm; unbedruckt; aufrastbar	www.wago.com/2009-145/000-023
	Art-Nr.: 2009-145/000-024 Mini-WSB Inline; auf Rolle; dehnbar 5 - 5,2 mm; unbedruckt; aufrastbar	www.wago.com/2009-145/000-024
	Art-Nr.: 248-501 Mini-WSB-Schnellbeschriftungssystem; unbedruckt; Schildchenbreite 5 mm; 10 Streifen à 10 Schilder pro Karte	www.wago.com/248-501
	Art-Nr.: 248-501/000-002 Mini-WSB-Beschriftungskarte; als Karte; nicht dehnbar; unbedruckt; aufrastbar	www.wago.com/248-501/000-002
	Art-Nr.: 248-501/000-005 Mini-WSB-Beschriftungskarte; als Karte; unbedruckt; aufrastbar	www.wago.com/248-501/000-005
	Art-Nr.: 248-501/000-006 Mini-WSB-Beschriftungskarte; als Karte; nicht dehnbar; unbedruckt; aufrastbar	www.wago.com/248-501/000-006
	Art-Nr.: 248-501/000-007 Mini-WSB-Beschriftungskarte; als Karte; nicht dehnbar; unbedruckt; aufrastbar	www.wago.com/248-501/000-007
	Art-Nr.: 248-501/000-012 Mini-WSB-Beschriftungskarte; als Karte; nicht dehnbar; unbedruckt; aufrastbar	www.wago.com/248-501/000-012
	Art-Nr.: 248-501/000-017 Mini-WSB-Beschriftungskarte; als Karte; nicht dehnbar; unbedruckt; aufrastbar	www.wago.com/248-501/000-017
	Art-Nr.: 248-501/000-023 Mini-WSB-Beschriftungskarte; als Karte; nicht dehnbar; unbedruckt; aufrastbar	www.wago.com/248-501/000-023
	Art-Nr.: 248-501/000-024 Mini-WSB-Beschriftungskarte; als Karte; nicht dehnbar; unbedruckt; aufrastbar	www.wago.com/248-501/000-024
Abschlussplatte		
	Art-Nr.: 769-307 Abschluss- und Zwischenplatte; 1,1 mm dick	www.wago.com/769-307
	Art-Nr.: 769-308 Abschluss- und Zwischenplatte; 1,1 mm dick	www.wago.com/769-308
Isolierungs-Stopp		
	Art-Nr.: 769-470 Isolierungsstopp; 0,08 - 0,2 mm ² "e" (0,14 mm ² "f"); 5 Stück / Strang	www.wago.com/769-470



Art-Nr.: 769-471
Isolierungsstopp; 0,25 - 0,5 mm²; 5 Stück / Strang

www.wago.com/769-471



Art-Nr.: 769-472
Isolierungsstopp; 0,75 - 1 mm²; 5 Stück / Strang

www.wago.com/769-472

Tragschiene



Art-Nr.: 210-112
Stahltragschiene; 35 x 7,5 mm; 1 mm dick; 2 m lang; gelocht; entsprechend EN 60715; Lochbreite 25 mm; Lochabstand 36 mm www.wago.com/210-112



Art-Nr.: 210-113
Stahltragschiene; 35 x 7,5 mm; 1 mm dick; 2 m lang; ungelocht; entsprechend EN 60715 www.wago.com/210-113



Art-Nr.: 210-114
Stahltragschiene; 35 x 15 mm; 1,5 mm dick; 2 m lang; ungelocht; ähnlich EN 60715 www.wago.com/210-114



Art-Nr.: 210-115
Stahltragschiene; 35 x 7,5 mm; 1 mm dick; 2 m lang; gelocht; entsprechend EN 60715; Lochbreite 18 mm; Lochabstand 25 mm www.wago.com/210-115



Art-Nr.: 210-118
Stahltragschiene; 35 x 15 mm; 2,3 mm dick; 2 m lang; ungelocht; entsprechend EN 60715 www.wago.com/210-118



Art-Nr.: 210-196
Aluminiumtragschiene; 35 x 8,2 mm; 1,6 mm dick; 2 m lang; ungelocht; ähnlich EN 60715 www.wago.com/210-196



Art-Nr.: 210-197
Stahltragschiene; 35 x 15 mm; 1,5 mm dick; 2 m lang; gelocht; ähnlich EN 60715 www.wago.com/210-197



Art-Nr.: 210-198
Kupfertragschiene; 35 x 15 mm; 2,3 mm dick; 2 m lang; ungelocht; entsprechend EN 60715 www.wago.com/210-198



Art-Nr.: 210-504
Stahltragschiene; 35 x 7,5 mm; 1 mm dick; 2 m lang; gelocht; bandverzinkt; entsprechend EN 60715 www.wago.com/210-504



Art-Nr.: 210-505
Stahltragschiene; 35 x 7,5 mm; 1 mm dick; 2 m lang; ungelocht; bandverzinkt; entsprechend EN 60715 www.wago.com/210-505



Art-Nr.: 210-506
Stahltragschiene; 35 x 15 mm; 1,5 mm dick; 2 m lang; ungelocht; bandverzinkt; ähnlich EN 60715 www.wago.com/210-506



Art-Nr.: 210-508
Stahltragschiene; 35 x 15 mm; 1,5 mm dick; 2 m lang; gelocht; bandverzinkt; ähnlich EN 60715 www.wago.com/210-508

Kodierung



Art-Nr.: 769-435
Kodierstift; zur Kodierung der Federleisten; für Basisklemmen / Stiftleisten www.wago.com/769-435

Werkzeug



Art-Nr.: 210-720
Betätigungswerkzeug mit teilisoliertem Schaft; Typ 2, Klinge (3,5 x 0,5) mm www.wago.com/210-720

Prüfen und Messen



Art-Nr.: 210-136
Prüfstecker; Ø 2 mm; mit 500mm-Leitung

www.wago.com/210-136



Art-Nr.: 210-137
Prüfstecker; Ø 2,3 mm; mit 500mm-Leitung

www.wago.com/210-137

Brücker



Art-Nr.: 249-123
Steckbarer Leitungsbrücker; isoliert; L = 180 mm; Leitungsquerschnitt 0,75 mm²

www.wago.com/249-123



Art-Nr.: 249-125
Steckbarer Leitungsbrücker; isoliert; L = 60 mm; Leitungsquerschnitt 0,75 mm²

www.wago.com/249-125



Art-Nr.: 249-126
Steckbarer Leitungsbrücker; isoliert; L = 110 mm; Leitungsquerschnitt 0,75 mm²

www.wago.com/249-126



Art-Nr.: 249-127
Steckbarer Leitungsbrücker; isoliert; L = 250 mm; Leitungsquerschnitt 0,75 mm²

www.wago.com/249-127



Art-Nr.: 280-402
Querbrücker; isoliert; IN = IN Klemme

www.wago.com/280-402



Art-Nr.: 280-409
Doppelteilungsquerbrücker; isoliert; IN = IN Klemme

www.wago.com/280-409



Art-Nr.: 780-452
Schachtelbrücker; isoliert; von 1 auf 2; Teilung 5 mm; passend für 2-Leiter-Federleisten

www.wago.com/780-452



Art-Nr.: 780-453
Schachtelbrücker; isoliert; von 1 auf 3; Teilung 5 mm; passend für 2-Leiter-Federleisten

www.wago.com/780-453



Art-Nr.: 780-454
Schachtelbrücker; isoliert; von 1 auf 4; Teilung 5 mm; passend für 2-Leiter-Federleisten

www.wago.com/780-454



Art-Nr.: 780-455
Schachtelbrücker; isoliert; von 1 auf 5; Teilung 5 mm; passend für 2-Leiter-Federleisten

www.wago.com/780-455



Art-Nr.: 780-456
Schachtelbrücker; isoliert; von 1 auf 6; Teilung 5 mm; passend für 2-Leiter-Federleisten

www.wago.com/780-456



Art-Nr.: 780-457
Schachtelbrücker; isoliert; von 1 auf 7; Teilung 5 mm; passend für 2-Leiter-Federleisten

www.wago.com/780-457



Art-Nr.: 780-458
Schachtelbrücker; isoliert; von 1 auf 8; Teilung 5 mm; passend für 2-Leiter-Federleisten

www.wago.com/780-458

Montage



Art-Nr.: 209-106
Haltebock; zur isolierten Montage von Tragschienen DIN 35

www.wago.com/209-106











Warnabdeckung



Art-Nr.: 280-415
Warnabdeckung; mit schwarzem Blitzpfeil; für 5 Klemmen

www.wago.com/280-415

Federleiste

	Art-Nr.: 769-101 1-Leiter-Federleiste; 4 mm ² ; 1-polig	www.wago.com/769-101
	Art-Nr.: 769-101/000-006 1-Leiter-Federleiste; 4 mm ² ; 1-polig	www.wago.com/769-101/000-006
	Art-Nr.: 769-101/000-016 1-Leiter-Federleiste; 4 mm ² ; 1-polig	www.wago.com/769-101/000-016
	Art-Nr.: 769-101/022-000 1-Leiter-Federleiste; abgewinkelt; 4 mm ² ; 1-polig	www.wago.com/769-101/022-000
	Art-Nr.: 769-101/022-016 1-Leiter-Federleiste; abgewinkelt; 4 mm ² ; 1-polig	www.wago.com/769-101/022-016
	Art-Nr.: 769-102 1-Leiter-Federleiste; 4 mm ² ; 2-polig	www.wago.com/769-102
	Art-Nr.: 769-102/000-006 1-Leiter-Federleiste; 4 mm ² ; 2-polig	www.wago.com/769-102/000-006
	Art-Nr.: 769-102/000-036 1-Leiter-Federleiste; 4 mm ² ; 2-polig	www.wago.com/769-102/000-036
	Art-Nr.: 769-102/000-037 1-Leiter-Federleiste; 4 mm ² ; 2-polig	www.wago.com/769-102/000-037
	Art-Nr.: 769-102/022-000 1-Leiter-Federleiste; abgewinkelt; 4 mm ² ; 2-polig	www.wago.com/769-102/022-000
	Art-Nr.: 769-103 1-Leiter-Federleiste; 4 mm ² ; 3-polig	www.wago.com/769-103
	Art-Nr.: 769-103/000-006 1-Leiter-Federleiste; 4 mm ² ; 3-polig	www.wago.com/769-103/000-006
	Art-Nr.: 769-103/000-036 1-Leiter-Federleiste; 4 mm ² ; 3-polig	www.wago.com/769-103/000-036
	Art-Nr.: 769-103/000-037 1-Leiter-Federleiste; 4 mm ² ; 3-polig	www.wago.com/769-103/000-037
	Art-Nr.: 769-103/000-038 1-Leiter-Federleiste; 4 mm ² ; 3-polig	www.wago.com/769-103/000-038



Art-Nr.: 769-103/000-039
1-Leiter-Federleiste; 4 mm²; 3-polig

www.wago.com/769-103/000-039



Art-Nr.: 769-103/022-000
1-Leiter-Federleiste; abgewinkelt; 4 mm²; 3-polig

www.wago.com/769-103/022-000

Art-Nr.: 769-104
1-Leiter-Federleiste; 4 mm²; 4-polig

www.wago.com/769-104

Art-Nr.: 769-104/000-006
1-Leiter-Federleiste; 4 mm²; 4-polig

www.wago.com/769-104/000-006



Art-Nr.: 769-104/000-036
1-Leiter-Federleiste; 4 mm²; 4-polig

www.wago.com/769-104/000-036



Art-Nr.: 769-104/000-037
1-Leiter-Federleiste; 4 mm²; 4-polig

www.wago.com/769-104/000-037



Art-Nr.: 769-104/000-038
1-Leiter-Federleiste; 4 mm²; 4-polig

www.wago.com/769-104/000-038



Art-Nr.: 769-104/000-039
1-Leiter-Federleiste; 4 mm²; 4-polig

www.wago.com/769-104/000-039



Art-Nr.: 769-104/022-000
1-Leiter-Federleiste; abgewinkelt; 4 mm²; 4-polig

www.wago.com/769-104/022-000



Art-Nr.: 769-105
1-Leiter-Federleiste; 4 mm²; 5-polig

www.wago.com/769-105



Art-Nr.: 769-105/000-006
1-Leiter-Federleiste; 4 mm²; 5-polig

www.wago.com/769-105/000-006



Art-Nr.: 769-105/000-036
1-Leiter-Federleiste; 4 mm²; 5-polig

www.wago.com/769-105/000-036



Art-Nr.: 769-105/000-037
1-Leiter-Federleiste; 4 mm²; 5-polig

www.wago.com/769-105/000-037



Art-Nr.: 769-105/000-038
1-Leiter-Federleiste; 4 mm²; 5-polig

www.wago.com/769-105/000-038



Art-Nr.: 769-105/000-039
1-Leiter-Federleiste; 4 mm²; 5-polig

www.wago.com/769-105/000-039



Art-Nr.: 769-105/022-000
1-Leiter-Federleiste; abgewinkelt; 4 mm²; 5-polig

www.wago.com/769-105/022-000

Art-Nr.: 769-106
1-Leiter-Federleiste; 4 mm²; 6-polig

www.wago.com/769-106

Art-Nr.: 769-106/000-006
1-Leiter-Federleiste; 4 mm²; 6-polig

www.wago.com/769-106/000-006



Art-Nr.: 769-106/000-036
1-Leiter-Federleiste; 4 mm²; 6-polig

www.wago.com/769-106/000-036



Art-Nr.: 769-106/000-037
1-Leiter-Federleiste; 4 mm²; 6-polig

www.wago.com/769-106/000-037



Art-Nr.: 769-106/000-038
1-Leiter-Federleiste; 4 mm²; 6-polig

www.wago.com/769-106/000-038



Art-Nr.: 769-106/000-039
1-Leiter-Federleiste; 4 mm²; 6-polig

www.wago.com/769-106/000-039

Art-Nr.: 769-106/022-000
1-Leiter-Federleiste; abgewinkelt; 4 mm²; 6-polig

www.wago.com/769-106/022-000

Art-Nr.: 769-107
1-Leiter-Federleiste; 4 mm²; 7-polig

www.wago.com/769-107

Art-Nr.: 769-107/000-006
1-Leiter-Federleiste; 4 mm²; 7-polig

www.wago.com/769-107/000-006



Art-Nr.: 769-107/000-036
1-Leiter-Federleiste; 4 mm²; 7-polig

www.wago.com/769-107/000-036



Art-Nr.: 769-107/000-037
1-Leiter-Federleiste; 4 mm²; 7-polig

www.wago.com/769-107/000-037



Art-Nr.: 769-107/000-038
1-Leiter-Federleiste; 4 mm²; 7-polig

www.wago.com/769-107/000-038







Art-Nr.: 769-107/000-039
1-Leiter-Federleiste; 4 mm²; 7-polig

www.wago.com/769-107/000-039

Art-Nr.: 769-107/022-000
1-Leiter-Federleiste; abgewinkelt; 4 mm²; 7-polig

www.wago.com/769-107/022-000

Art-Nr.: 769-108

	1-Leiter-Federleiste; 4 mm ² ; 8-polig	www.wago.com/769-108
	Art-Nr.: 769-108/000-006 1-Leiter-Federleiste; 4 mm ² ; 8-polig	www.wago.com/769-108/000-006
	Art-Nr.: 769-108/000-036 1-Leiter-Federleiste; 4 mm ² ; 8-polig	www.wago.com/769-108/000-036
	Art-Nr.: 769-108/000-037 1-Leiter-Federleiste; 4 mm ² ; 8-polig	www.wago.com/769-108/000-037
	Art-Nr.: 769-108/000-038 1-Leiter-Federleiste; 4 mm ² ; 8-polig	www.wago.com/769-108/000-038
	Art-Nr.: 769-108/000-039 1-Leiter-Federleiste; 4 mm ² ; 8-polig	www.wago.com/769-108/000-039
	Art-Nr.: 769-108/022-000 1-Leiter-Federleiste; abgewinkelt; 4 mm ² ; 8-polig	www.wago.com/769-108/022-000
	Art-Nr.: 769-109 1-Leiter-Federleiste; 4 mm ² ; 9-polig	www.wago.com/769-109
	Art-Nr.: 769-109/000-006 1-Leiter-Federleiste; 4 mm ² ; 9-polig	www.wago.com/769-109/000-006
	Art-Nr.: 769-109/000-036 1-Leiter-Federleiste; 4 mm ² ; 9-polig	www.wago.com/769-109/000-036
	Art-Nr.: 769-109/000-037 1-Leiter-Federleiste; 4 mm ² ; 9-polig	www.wago.com/769-109/000-037
	Art-Nr.: 769-109/000-038 1-Leiter-Federleiste; 4 mm ² ; 9-polig	www.wago.com/769-109/000-038
	Art-Nr.: 769-109/000-039 1-Leiter-Federleiste; 4 mm ² ; 9-polig	www.wago.com/769-109/000-039
	Art-Nr.: 769-109/022-000 1-Leiter-Federleiste; abgewinkelt; 4 mm ² ; 9-polig	www.wago.com/769-109/022-000
	Art-Nr.: 769-110 1-Leiter-Federleiste; 4 mm ² ; 10-polig	www.wago.com/769-110
	Art-Nr.: 769-110/000-006 1-Leiter-Federleiste; 4 mm ² ; 10-polig	www.wago.com/769-110/000-006

<p>Art-Nr.: 769-110/000-036 1-Leiter-Federleiste; 4 mm²; 10-polig</p>	<p>www.wago.com/769-110/000-036</p>	
<p>Art-Nr.: 769-110/000-037 1-Leiter-Federleiste; 4 mm²; 10-polig</p>	<p>www.wago.com/769-110/000-037</p>	
<p>Art-Nr.: 769-110/000-038 1-Leiter-Federleiste; 4 mm²; 10-polig</p>	<p>www.wago.com/769-110/000-038</p>	
<p>Art-Nr.: 769-110/000-039 1-Leiter-Federleiste; 4 mm²; 10-polig</p>	<p>www.wago.com/769-110/000-039</p>	
<p>Art-Nr.: 769-110/022-000 1-Leiter-Federleiste; abgewinkelt; 4 mm²; 10-polig</p>	<p>www.wago.com/769-110/022-000</p>	
<p>Art-Nr.: 769-111 1-Leiter-Federleiste; 4 mm²; 11-polig</p>	<p>www.wago.com/769-111</p>	
<p>Art-Nr.: 769-111/000-006 1-Leiter-Federleiste; 4 mm²; 11-polig</p>	<p>www.wago.com/769-111/000-006</p>	
<p>Art-Nr.: 769-111/000-036 1-Leiter-Federleiste; 4 mm²; 11-polig</p>	<p>www.wago.com/769-111/000-036</p>	
<p>Art-Nr.: 769-111/000-037 1-Leiter-Federleiste; 4 mm²; 11-polig</p>	<p>www.wago.com/769-111/000-037</p>	
<p>Art-Nr.: 769-111/000-038 1-Leiter-Federleiste; 4 mm²; 11-polig</p>	<p>www.wago.com/769-111/000-038</p>	
<p>Art-Nr.: 769-111/000-039 1-Leiter-Federleiste; 4 mm²; 11-polig</p>	<p>www.wago.com/769-111/000-039</p>	
<p>Art-Nr.: 769-111/022-000 1-Leiter-Federleiste; abgewinkelt; 4 mm²; 11-polig</p>	<p>www.wago.com/769-111/022-000</p>	
<p>Art-Nr.: 769-112 1-Leiter-Federleiste; 4 mm²; 12-polig</p>	<p>www.wago.com/769-112</p>	
<p>Art-Nr.: 769-112/000-006 1-Leiter-Federleiste; 4 mm²; 12-polig</p>	<p>www.wago.com/769-112/000-006</p>	
	<p>Art-Nr.: 769-112/000-036 1-Leiter-Federleiste; 4 mm²; 12-polig</p>	<p>www.wago.com/769-112/000-036</p>



Art-Nr.: 769-112/000-037
1-Leiter-Federleiste; 4 mm²; 12-polig

www.wago.com/769-112/000-037



Art-Nr.: 769-112/000-038
1-Leiter-Federleiste; 4 mm²; 12-polig

www.wago.com/769-112/000-038



Art-Nr.: 769-112/000-039
1-Leiter-Federleiste; 4 mm²; 12-polig

www.wago.com/769-112/000-039

Art-Nr.: 769-112/022-000
1-Leiter-Federleiste; abgewinkelt; 4 mm²; 12-polig

www.wago.com/769-112/022-000

Art-Nr.: 769-113
1-Leiter-Federleiste; 4 mm²; 13-polig

www.wago.com/769-113

Art-Nr.: 769-113/000-036
1-Leiter-Federleiste; 4 mm²; 13-polig

www.wago.com/769-113/000-036

Art-Nr.: 769-113/000-037
1-Leiter-Federleiste; 4 mm²; 13-polig

www.wago.com/769-113/000-037

Art-Nr.: 769-113/000-038
1-Leiter-Federleiste; 4 mm²; 13-polig

www.wago.com/769-113/000-038

Art-Nr.: 769-113/000-039
1-Leiter-Federleiste; 4 mm²; 13-polig

www.wago.com/769-113/000-039

Art-Nr.: 769-113/022-000
1-Leiter-Federleiste; abgewinkelt; 4 mm²; 13-polig

www.wago.com/769-113/022-000

Art-Nr.: 769-114
1-Leiter-Federleiste; 4 mm²; 14-polig

www.wago.com/769-114

Art-Nr.: 769-114/000-006
1-Leiter-Federleiste; 4 mm²; 14-polig

www.wago.com/769-114/000-006

Art-Nr.: 769-114/000-036
1-Leiter-Federleiste; 4 mm²; 14-polig





www.wago.com/769-114/000-036

Art-Nr.: 769-114/000-037
1-Leiter-Federleiste; 4 mm²; 14-polig

www.wago.com/769-114/000-037

Art-Nr.: 769-114/000-038
1-Leiter-Federleiste; 4 mm²; 14-polig

www.wago.com/769-114/000-038

<p>Art-Nr.: 769-114/000-039 1-Leiter-Federleiste; 4 mm²; 14-polig</p>	<p>www.wago.com/769-114/000-039</p>
<p>Art-Nr.: 769-114/022-000 1-Leiter-Federleiste; abgewinkelt; 4 mm²; 14-polig</p>	<p>www.wago.com/769-114/022-000</p>
<p>Art-Nr.: 769-115 1-Leiter-Federleiste; 4 mm²; 15-polig</p>	<p>www.wago.com/769-115</p>
<p>Art-Nr.: 769-115/000-036 1-Leiter-Federleiste; 4 mm²; 15-polig</p>	<p>www.wago.com/769-115/000-036</p>
<p>Art-Nr.: 769-115/000-037 1-Leiter-Federleiste; 4 mm²; 15-polig</p>	<p>www.wago.com/769-115/000-037</p>
<p>Art-Nr.: 769-115/000-038 1-Leiter-Federleiste; 4 mm²; 15-polig</p>	<p>www.wago.com/769-115/000-038</p>
<p>Art-Nr.: 769-115/000-039 1-Leiter-Federleiste; 4 mm²; 15-polig</p>	<p>www.wago.com/769-115/000-039</p>
<p>Art-Nr.: 769-115/022-000 1-Leiter-Federleiste; abgewinkelt; 4 mm²; 15-polig</p>	<p>www.wago.com/769-115/022-000</p>
<p> Art-Nr.: 769-121 2-Leiter-Federleiste; 4 mm²; 1-polig</p>	<p>www.wago.com/769-121</p>
<p> Art-Nr.: 769-121/000-016 2-Leiter-Federleiste; 4 mm²; 1-polig</p>	<p>www.wago.com/769-121/000-016</p>
<p> Art-Nr.: 769-122 2-Leiter-Federleiste; 4 mm²; 2-polig</p>	<p>www.wago.com/769-122</p>
<p>Art-Nr.: 769-123 2-Leiter-Federleiste; 4 mm²; 3-polig</p>	<p>www.wago.com/769-123</p>
<p>Art-Nr.: 769-124 2-Leiter-Federleiste; 4 mm²; 4-polig</p>	<p>www.wago.com/769-124</p>
<p> Art-Nr.: 769-125 2-Leiter-Federleiste; 4 mm²; 5-polig</p>	<p>www.wago.com/769-125</p>
<p>Art-Nr.: 769-126 2-Leiter-Federleiste; 4 mm²; 6-polig</p>	<p>www.wago.com/769-126</p>
<p>Art-Nr.: 769-127 2-Leiter-Federleiste; 4 mm²; 7-polig</p>	<p>www.wago.com/769-127</p>
<p>Art-Nr.: 769-128 2-Leiter-Federleiste; 4 mm²; 8-polig</p>	<p>www.wago.com/769-128</p>



Art-Nr.: 769-129 2-Leiter-Federleiste; 4 mm ² ; 9-polig	www.wago.com/769-129
Art-Nr.: 769-130 2-Leiter-Federleiste; 4 mm ² ; 10-polig	www.wago.com/769-130
Art-Nr.: 769-131 2-Leiter-Federleiste; 4 mm ² ; 11-polig	www.wago.com/769-131
Art-Nr.: 769-132 2-Leiter-Federleiste; 4 mm ² ; 12-polig	www.wago.com/769-132
Art-Nr.: 769-133 2-Leiter-Federleiste; 4 mm ² ; 13-polig	www.wago.com/769-133
Art-Nr.: 769-134 2-Leiter-Federleiste; 4 mm ² ; 14-polig	www.wago.com/769-134
Art-Nr.: 769-135 2-Leiter-Federleiste; 4 mm ² ; 15-polig	www.wago.com/769-135

Downloads

Dokumentation

Ausschreibungstext

769-176	Oct 18, 2017	DOC 25,1 kB	Download
---------	--------------	----------------	----------

smartDATA

CAD Daten

3D Download 769-176	URL	Download
---------------------	-----	----------

Produktfamilie

X-COM

Die steckbaren Reihenklammersysteme X-COM® und X-COM® S sowie X-COM®S-MINI haben ihren Einsatzschwerpunkt im Schaltanlagen- und Steuerungsbau (z. B. in der Bahntechnik). Sie erfüllen die Aufgaben von Reihenklammern und sind zudem steckbar als auch modular aufbaubar.

[Mehr über die Produktfamilie erfahren](#)

[Alle Produkte der Familie anzeigen](#)



Änderungen vorbehalten.

WAGO Kontakttechnik GmbH & Co. KG
Hansastr. 27
32423 Minden
Telefon: +49571 887-0
E-Mail: info.de@wago.com | Web: www.wago.com

Haben Sie Fragen zu unseren Produkten?
Wir stehen Ihnen telefonisch unter +49 (571) 887-44222 gern zur
Verfügung.