

## Datenblatt | Artikelnummer: 2002-1202

2-Leiter-Durchgangsklemme; 2,5 mm<sup>2</sup>; für Anwendungen Ex e II geeignet;  
seitliche und mittige Beschriftung; für Tragschiene 35 x 15 und 35 x 7,5;  
Push-in CAGE CLAMP®

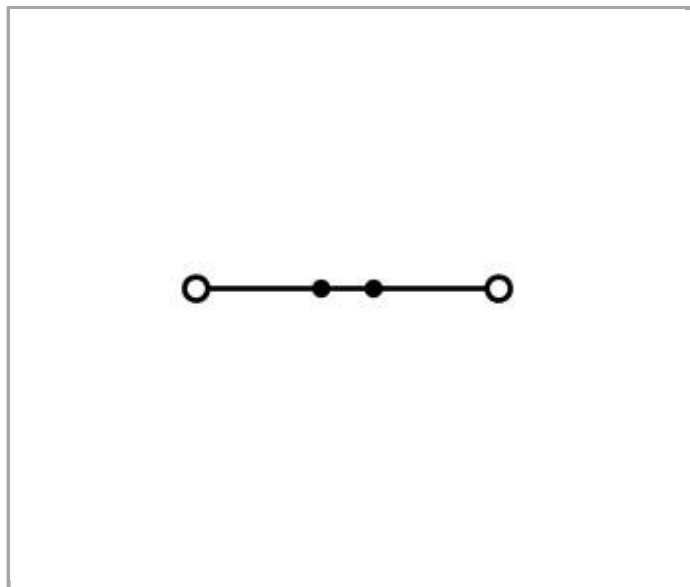

[www.wago.com/2002-1202](http://www.wago.com/2002-1202)

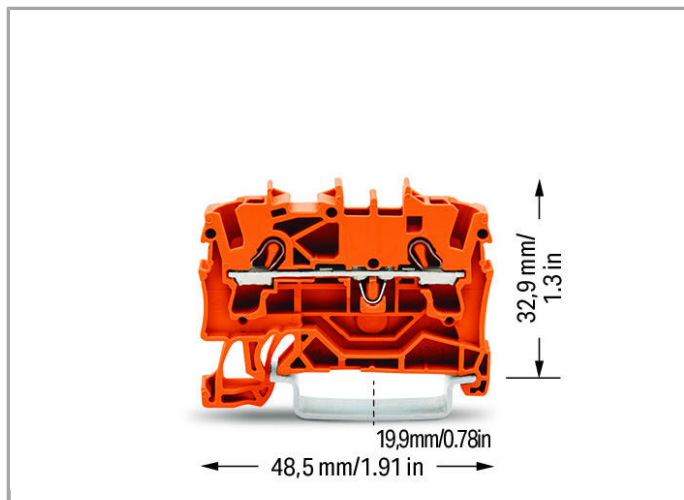

### Daten

#### Elektrische Daten

Bemessungsspannung EN (Ex e II)	550 V
Bemessungsstrom (Ex e II)	22 A



Bemessungsstrom (Ex e II) mit Brücke	20 A
--------------------------------------	------

### Bemessungsdaten gemäß IEC/EN 60664-1

Bemessungsspannung (III / 3)	800 V
Bemessungsstoßspannung (III / 3)	8 kV
Bemessungsstrom	24 A
Bemessungsstrom 2	32 A
Legende Bemessungsdaten	(III / 3) ≙ Überspannungskategorie III / Verschmutzungsgrad 3

### Bemessungsdaten gemäß UL 1059

Bemessungsspannung UL (Use Group B)	600 V
Bemessungsstrom UL (Use Group B)	20 A
Bemessungsspannung UL (Use Group C)	600 V
Bemessungsstrom UL (Use Group C)	20 A

### Bemessungsdaten gemäß CSA

Bemessungsspannung CSA (Use Group B)	600 V
Bemessungsstrom CSA (Use Group B)	20 A
Bemessungsspannung CSA (Use Group C)	600 V
Bemessungsstrom CSA (Use Group C)	20 A

### Anschlussdaten

Anschlusstechnik	Push-in CAGE CLAMP®
Betätigungsart	Push-in Betätigungswerkzeug
Anschließbare Leiterwerkstoffe	Kupfer
Nennquerschnitt	2,5 mm <sup>2</sup>
Eindrätiger Leiter	0,25 ... 4 mm <sup>2</sup> / 22 ... 12 AWG
Eindrätiger Leiter, direkt steckbar	0,75 ... 4 mm <sup>2</sup> / 18 ... 12 AWG
Feindrätiger Leiter	0,25 ... 4 mm <sup>2</sup> / 22 ... 12 AWG
Feindrätiger Leiter; mit Aderendhülse, direkt steckbar ab	0,75 mm <sup>2</sup> / 18 AWG
Abisolierlänge	10 ... 12 mm / 0.39 ... 0.47 inch
Gesamte Anzahl der Klemmstellen	2
Gesamte Anzahl der Potentiale	1
Anzahl der Ebenen	1
Verdrahtungsart	Frontverdrahtung

### Geometrische Daten

Breite	5,2 mm / 0.205 inch
Höhe ab Oberkante Tragschiene	32,9 mm / 1.295 inch

Tiefe 48,5 mm / 1.909 inch

### Mechanische Daten

Bauform	horizontale Bauform
Montageart	Tragschiene 35
Beschriftungsebene	Mitten-/Seitliche Beschriftung

### Werkstoffdaten

Farbe	orange
Isolierwerkstoff	Polyamid 66 (PA 66)
Brandlast	0.109 MJ
Gewicht	5.079 g

### Kaufmännische Daten





Ursprungsland	DE
GTIN	4017332999182
Zolltarifnummer	85369010000
Produktgruppe	22 (TOPJOB S Reihenklemmen)
eCl@ss 9.0	27-14-11-20
eCl@ss 8.0	27-14-11-20
ETIM 6.0	EC000897
ETIM 5.0	EC000897

### Zulassungen / Zertifikate





#### Ex-Zulassungen

Logo	Zulassung	Zertifikatsname
	AEx UL International Germany GmbH c/o Physikalisch Technische Bundesanstalt	E185892 sec.7
	AEx UL International Germany GmbH c/o Physikalisch Technische Bundesanstalt	E185892 sec.7
	ATEX Physikalisch Technische Bundesanstalt (PTB)	PTB 03 ATEX 1162 U (II 2 G/D Ex e II bzw. I M 2 Ex e I)
	IECEX Physikalisch Technische Bundesanstalt	IECEX PTB 03.0004U

## Länderspezifische Zulassungen

Logo	Zulassung	Zertifikatsname
	<b>CCA</b> DEKRA Certification B.V.	NTR NL 7585
	<b>CSA</b> DEKRA Certification B.V.	1536069
	<b>CSA</b> DEKRA Certification B.V.	1536069
	<b>KEMA/KEUR</b> DEKRA Certification B.V.	2198985.01

## Schiff Zulassungen

Logo	Zulassung	Zertifikatsname
	<b>ABS</b> American Bureau of Shipping	14-HG1293677-PDA
	<b>BV</b> Bureau Veritas S.A.	38586/A0 BV
	<b>DNV GL</b> Det Norske Veritas, Germanischer Lloyd	TAE00001V2
	<b>LR</b> Lloyds Register	91/20112 (E9)

## UL-Zulassungen

Logo	Zulassung	Zertifikatsname
	<b>cURus</b> Underwriters Laboratories Inc.	E45172

## Passende Produkte

### Warnabdeckung



**Art-Nr.: 2002-115**  
Warnabdeckung; mit schwarzem Blitzpfeil; für 5 Klemmen

[www.wago.com/2002-115](http://www.wago.com/2002-115)

### Prüfen und Messen



**Art-Nr.: 2002-511**  
Modularer TOPJOB®S-Steckverbinder; anreihbar; für Brückerschlitze; 1-polig

[www.wago.com/2002-511](http://www.wago.com/2002-511)



**Art-Nr.: 2002-549**  
Blindmodul; anreihbar; zum Überspringen von z. B. gebrückten Klemmen

[www.wago.com/2002-549](http://www.wago.com/2002-549)



**Art-Nr.: 2002-552**  
TOPJOB®S-Steckverbinderleiste; für Brückerschlitze; 2-polig

[www.wago.com/2002-552](http://www.wago.com/2002-552)



**Art-Nr.: 2002-553**  
TOPJOB®S-Steckverbinderleiste; für Brückerschlitze; 3-polig

[www.wago.com/2002-553](http://www.wago.com/2002-553)



**Art-Nr.: 2002-554**  
TOPJOB®S-Steckverbinderleiste; für Brückerschlitze; 4-polig

[www.wago.com/2002-554](http://www.wago.com/2002-554)



**Art-Nr.: 2002-555**  
TOPJOB®S-Steckverbinderleiste; für Brückerschlitze; 5-polig

[www.wago.com/2002-555](http://www.wago.com/2002-555)



**Art-Nr.: 2002-556**  
TOPJOB®S-Steckverbinderleiste; für Brückerschlitze; 6-polig

[www.wago.com/2002-556](http://www.wago.com/2002-556)



**Art-Nr.: 2002-557**  
TOPJOB®S-Steckverbinderleiste; für Brückerschlitze; 7-polig

[www.wago.com/2002-557](http://www.wago.com/2002-557)



**Art-Nr.: 2002-558**  
TOPJOB®S-Steckverbinderleiste; für Brückerschlitze; 8-polig

[www.wago.com/2002-558](http://www.wago.com/2002-558)



**Art-Nr.: 2002-559**  
TOPJOB®S-Steckverbinderleiste; für Brückerschlitze; 9-polig

[www.wago.com/2002-559](http://www.wago.com/2002-559)



**Art-Nr.: 2002-560**  
TOPJOB®S-Steckverbinderleiste; für Brückerschlitze; 10-polig

[www.wago.com/2002-560](http://www.wago.com/2002-560)



**Art-Nr.: 2002-611**  
TOPJOB®S-L-Prüfsteckermodul; anreihbar; 1-polig

[www.wago.com/2002-611](http://www.wago.com/2002-611)



**Art-Nr.: 2002-649**  
TOPJOB®S-L-Blindmodul; anreihbar; zum Überspringen von z. B. gebrückten Klemmen

[www.wago.com/2002-649](http://www.wago.com/2002-649)



**Art-Nr.: 2009-174**  
Prüfadapter; für Prüfstecker Ø 4 mm; zur Prüfung von TOPJOB®S-Reihenklemmen

[www.wago.com/2009-174](http://www.wago.com/2009-174)



**Art-Nr.: 2009-182**  
Prüfabgriff; für max. 2,5 mm<sup>2</sup>; für den werkzeuglosen Anschluss individueller Prüfleitungen von 0,08 mm - 2,5 mm

















[www.wago.com/2009-182](http://www.wago.com/2009-182)





### Abschlussplatte







**Art-Nr.: 2002-1291**  
Abschluss- und Zwischenplatte; 0,8 mm dick

[www.wago.com/2002-1291](http://www.wago.com/2002-1291)







	<b>Art-Nr.: 2002-1292</b> Abschluss- und Zwischenplatte; 0,8 mm dick	<a href="http://www.wago.com/2002-1292">www.wago.com/2002-1292</a>
	<b>Art-Nr.: 2002-1293</b> Trennwand; 2 mm dick; überstehend	<a href="http://www.wago.com/2002-1293">www.wago.com/2002-1293</a>
	<b>Art-Nr.: 2002-1294</b> Trennwand; 2 mm dick; überstehend	<a href="http://www.wago.com/2002-1294">www.wago.com/2002-1294</a>
	<b>Art-Nr.: 209-190</b> Trennwand Ex e/Ex i; 3 mm dick; 90 mm breit	<a href="http://www.wago.com/209-190">www.wago.com/209-190</a>
	<b>Art-Nr.: 209-191</b> Trennwand Ex e/Ex i; 3 mm dick; 120 mm breit	<a href="http://www.wago.com/209-191">www.wago.com/209-191</a>
<b>Tragschiene</b>		
	<b>Art-Nr.: 210-112</b> Stahltragschiene; 35 x 7,5 mm; 1 mm dick; 2 m lang; gelocht; entsprechend EN 60715; Lochbreite 25 mm; Lochabstand 36 mm	<a href="http://www.wago.com/210-112">www.wago.com/210-112</a>
	<b>Art-Nr.: 210-113</b> Stahltragschiene; 35 x 7,5 mm; 1 mm dick; 2 m lang; ungelocht; entsprechend EN 60715	<a href="http://www.wago.com/210-113">www.wago.com/210-113</a>
	<b>Art-Nr.: 210-114</b> Stahltragschiene; 35 x 15 mm; 1,5 mm dick; 2 m lang; ungelocht; ähnlich EN 60715	<a href="http://www.wago.com/210-114">www.wago.com/210-114</a>
	<b>Art-Nr.: 210-115</b> Stahltragschiene; 35 x 7,5 mm; 1 mm dick; 2 m lang; gelocht; entsprechend EN 60715; Lochbreite 18 mm; Lochabstand 25 mm	<a href="http://www.wago.com/210-115">www.wago.com/210-115</a>
	<b>Art-Nr.: 210-118</b> Stahltragschiene; 35 x 15 mm; 2,3 mm dick; 2 m lang; ungelocht; entsprechend EN 60715	<a href="http://www.wago.com/210-118">www.wago.com/210-118</a>
	<b>Art-Nr.: 210-196</b> Aluminiumtragschiene; 35 x 8,2 mm; 1,6 mm dick; 2 m lang; ungelocht; ähnlich EN 60715	<a href="http://www.wago.com/210-196">www.wago.com/210-196</a>
	<b>Art-Nr.: 210-197</b> Stahltragschiene; 35 x 15 mm; 1,5 mm dick; 2 m lang; gelocht; ähnlich EN 60715	<a href="http://www.wago.com/210-197">www.wago.com/210-197</a>
	<b>Art-Nr.: 210-198</b> Kupfertragschiene; 35 x 15 mm; 2,3 mm dick; 2 m lang; ungelocht; entsprechend EN 60715	<a href="http://www.wago.com/210-198">www.wago.com/210-198</a>
<b>Aderendhülse</b>		
	<b>Art-Nr.: 216-241</b> Aderendhülse; Hülse für 0,5 mm <sup>2</sup> / AWG 22; mit Kunststoffkragen; galvanisch verzinkt; Elektrolytkupfer; gasdicht aufgecrimpt; gemäß DIN 46228, Teil 4/09.90	<a href="http://www.wago.com/216-241">www.wago.com/216-241</a>
	<b>Art-Nr.: 216-242</b> Aderendhülse; Hülse für 0,75 mm <sup>2</sup> / AWG 20; mit Kunststoffkragen; galvanisch verzinkt; Elektrolytkupfer; gasdicht aufgecrimpt; gemäß DIN 46228, Teil 4/09.90	<a href="http://www.wago.com/216-242">www.wago.com/216-242</a>
	<b>Art-Nr.: 216-243</b> Aderendhülse; Hülse für 1 mm <sup>2</sup> / AWG 18; mit Kunststoffkragen; galvanisch verzinkt; Elektrolytkupfer; gasdicht aufgecrimpt; gemäß DIN 46228, Teil 4/09.90	<a href="http://www.wago.com/216-243">www.wago.com/216-243</a>
	<b>Art-Nr.: 216-244</b> Aderendhülse; Hülse für 1,5 mm <sup>2</sup> / AWG 16; mit Kunststoffkragen; galvanisch verzinkt; Elektrolytkupfer; gasdicht aufgecrimpt; gemäß DIN 46228, Teil 4/09.90	<a href="http://www.wago.com/216-244">www.wago.com/216-244</a>
	<b>Art-Nr.: 216-246</b>	

















	Aderendhülse; Hülse für 2,5 mm <sup>2</sup> / AWG 14; mit Kunststoffkragen; galvanisch verzinkt; Elektrolytkupfer; gasdicht aufgecrimpt; gemäß DIN 46228, Teil 4/09.90	<a href="http://www.wago.com/216-246">www.wago.com/216-246</a>
	<b>Art-Nr.: 216-262</b> Aderendhülse; Hülse für 0,75 mm <sup>2</sup> / AWG 20; mit Kunststoffkragen; galvanisch verzinkt; Elektrolytkupfer; gasdicht aufgecrimpt; gemäß DIN 46228, Teil 4/09.90	<a href="http://www.wago.com/216-262">www.wago.com/216-262</a>
	<b>Art-Nr.: 216-263</b> Aderendhülse; Hülse für 1 mm <sup>2</sup> / AWG 18; mit Kunststoffkragen; galvanisch verzinkt; Elektrolytkupfer; gasdicht aufgecrimpt; gemäß DIN 46228, Teil 4/09.90	<a href="http://www.wago.com/216-263">www.wago.com/216-263</a>
	<b>Art-Nr.: 216-264</b> Aderendhülse; Hülse für 1,5 mm <sup>2</sup> / AWG 16; mit Kunststoffkragen; galvanisch verzinkt; Elektrolytkupfer; gasdicht aufgecrimpt; gemäß DIN 46228, Teil 4/09.90	<a href="http://www.wago.com/216-264">www.wago.com/216-264</a>
	<b>Art-Nr.: 216-266</b> Aderendhülse; Hülse für 2,5 mm <sup>2</sup> / AWG 14; mit Kunststoffkragen; galvanisch verzinkt; Elektrolytkupfer; gasdicht aufgecrimpt; gemäß DIN 46228, Teil 4/09.90	<a href="http://www.wago.com/216-266">www.wago.com/216-266</a>

#### Allgemeines Zubehör

	<b>Art-Nr.: 2002-880/1000-411</b> Diodenbaustein; mit Diode 1N4007 als Freilaufdiode; 10,4 mm breit; Betriebstemperatur 85 °C max.	<a href="http://www.wago.com/2002-880/1000-411">www.wago.com/2002-880/1000-411</a>
	<b>Art-Nr.: 2002-880/1000-541</b> LED-Baustein; mit roter LED; 10,4 mm breit; 12 - 30 V; Betriebstemperatur 85 °C max.	<a href="http://www.wago.com/2002-880/1000-541">www.wago.com/2002-880/1000-541</a>
	<b>Art-Nr.: 2002-880/1000-542</b> LED-Baustein	<a href="http://www.wago.com/2002-880/1000-542">www.wago.com/2002-880/1000-542</a>
	<b>Art-Nr.: 2002-880/1000-836</b> LED-Baustein; mit roter LED; 10,4 mm breit; 230 V; Betriebstemperatur 85 °C max.	<a href="http://www.wago.com/2002-880/1000-836">www.wago.com/2002-880/1000-836</a>

#### Beschriftungsmaterial

	<b>Art-Nr.: 2002-161</b> Adapter	<a href="http://www.wago.com/2002-161">www.wago.com/2002-161</a>
	<b>Art-Nr.: 2009-110</b> Beschriftungstreifen; auf Rolle; nicht dehnbar; unbedruckt; aufrastbar	<a href="http://www.wago.com/2009-110">www.wago.com/2009-110</a>
	<b>Art-Nr.: 2009-115</b> WMB-Inline; für smartPRINTER; auf Rolle; dehnbar 5 - 5,2 mm; unbedruckt; aufrastbar	<a href="http://www.wago.com/2009-115">www.wago.com/2009-115</a>
	<b>Art-Nr.: 2009-115/000-002</b> WMB-Inline; für smartPRINTER; auf Rolle; dehnbar 5 - 5,2 mm; unbedruckt; aufrastbar	<a href="http://www.wago.com/2009-115/000-002">www.wago.com/2009-115/000-002</a>
	<b>Art-Nr.: 2009-115/000-006</b> WMB-Inline; für smartPRINTER; auf Rolle; dehnbar 5 - 5,2 mm; unbedruckt; aufrastbar	<a href="http://www.wago.com/2009-115/000-006">www.wago.com/2009-115/000-006</a>
	<b>Art-Nr.: 2009-115/000-007</b> WMB-Inline; für smartPRINTER; auf Rolle; dehnbar 5 - 5,2 mm; unbedruckt; aufrastbar	<a href="http://www.wago.com/2009-115/000-007">www.wago.com/2009-115/000-007</a>

	<b>Art-Nr.: 2009-115/000-012</b> WMB-Inline; für smartPRINTER; auf Rolle; dehnbar 5 - 5,2 mm; unbedruckt; aufrastbar	<a href="http://www.wago.com/2009-115/000-012">www.wago.com/2009-115/000-012</a>
	<b>Art-Nr.: 2009-115/000-017</b> WMB-Inline; für smartPRINTER; auf Rolle; dehnbar 5 - 5,2 mm; unbedruckt; aufrastbar	<a href="http://www.wago.com/2009-115/000-017">www.wago.com/2009-115/000-017</a>
	<b>Art-Nr.: 2009-115/000-023</b> WMB-Inline; für smartPRINTER; auf Rolle; dehnbar 5 - 5,2 mm; unbedruckt; aufrastbar	<a href="http://www.wago.com/2009-115/000-023">www.wago.com/2009-115/000-023</a>
	<b>Art-Nr.: 2009-115/000-024</b> WMB-Inline; für smartPRINTER; auf Rolle; dehnbar 5 - 5,2 mm; unbedruckt; aufrastbar	<a href="http://www.wago.com/2009-115/000-024">www.wago.com/2009-115/000-024</a>
	<b>Art-Nr.: 2009-145</b> Mini-WSB Inline; für smartPRINTER; auf Rolle; dehnbar 5 - 5,2 mm; unbedruckt; aufrastbar	<a href="http://www.wago.com/2009-145">www.wago.com/2009-145</a>
	<b>Art-Nr.: 2009-145/000-002</b> Mini-WSB Inline; für smartPRINTER; auf Rolle; dehnbar 5 - 5,2 mm; unbedruckt; aufrastbar	<a href="http://www.wago.com/2009-145/000-002">www.wago.com/2009-145/000-002</a>
	<b>Art-Nr.: 2009-145/000-005</b> Mini-WSB Inline; für smartPRINTER; auf Rolle; dehnbar 5 - 5,2 mm; unbedruckt; aufrastbar	<a href="http://www.wago.com/2009-145/000-005">www.wago.com/2009-145/000-005</a>
	<b>Art-Nr.: 2009-145/000-006</b> Mini-WSB Inline; für smartPRINTER; auf Rolle; dehnbar 5 - 5,2 mm; unbedruckt; aufrastbar	<a href="http://www.wago.com/2009-145/000-006">www.wago.com/2009-145/000-006</a>
	<b>Art-Nr.: 2009-145/000-007</b> Mini-WSB Inline; für smartPRINTER; auf Rolle; dehnbar 5 - 5,2 mm; unbedruckt; aufrastbar	<a href="http://www.wago.com/2009-145/000-007">www.wago.com/2009-145/000-007</a>
	<b>Art-Nr.: 2009-145/000-012</b> Mini-WSB Inline; für smartPRINTER; auf Rolle; dehnbar 5 - 5,2 mm; unbedruckt; aufrastbar	<a href="http://www.wago.com/2009-145/000-012">www.wago.com/2009-145/000-012</a>
	<b>Art-Nr.: 2009-145/000-023</b> Mini-WSB Inline; für smartPRINTER; auf Rolle; dehnbar 5 - 5,2 mm; unbedruckt; aufrastbar	<a href="http://www.wago.com/2009-145/000-023">www.wago.com/2009-145/000-023</a>
	<b>Art-Nr.: 2009-145/000-024</b> Mini-WSB Inline; auf Rolle; dehnbar 5 - 5,2 mm; unbedruckt; aufrastbar	<a href="http://www.wago.com/2009-145/000-024">www.wago.com/2009-145/000-024</a>
	<b>Art-Nr.: 2009-191</b> Gruppenschildträger	<a href="http://www.wago.com/2009-191">www.wago.com/2009-191</a>
	<b>Art-Nr.: 2009-192</b> Gruppenschildträger	<a href="http://www.wago.com/2009-192">www.wago.com/2009-192</a>
	<b>Art-Nr.: 2009-193</b> Gruppenschildträger	<a href="http://www.wago.com/2009-193">www.wago.com/2009-193</a>
	<b>Art-Nr.: 2009-198</b> Adapter	<a href="http://www.wago.com/2009-198">www.wago.com/2009-198</a>





**Art-Nr.: 248-501**

Mini-WSB-Schnellbeschriftungssystem; unbedruckt; Schildchenbreite 5 mm; 10 Streifen à 10 Schilder pro Karte

[www.wago.com/248-501](http://www.wago.com/248-501)



**Art-Nr.: 248-501/000-002**

Mini-WSB-Beschriftungskarte; als Karte; nicht dehnbar; unbedruckt; aufrastbar

[www.wago.com/248-501/000-002](http://www.wago.com/248-501/000-002)



**Art-Nr.: 248-501/000-005**

Mini-WSB-Beschriftungskarte; als Karte; unbedruckt; aufrastbar

[www.wago.com/248-501/000-005](http://www.wago.com/248-501/000-005)



**Art-Nr.: 248-501/000-006**

Mini-WSB-Beschriftungskarte; als Karte; nicht dehnbar; unbedruckt; aufrastbar

[www.wago.com/248-501/000-006](http://www.wago.com/248-501/000-006)



**Art-Nr.: 248-501/000-007**

Mini-WSB-Beschriftungskarte; als Karte; nicht dehnbar; unbedruckt; aufrastbar

[www.wago.com/248-501/000-007](http://www.wago.com/248-501/000-007)



**Art-Nr.: 248-501/000-012**

Mini-WSB-Beschriftungskarte; als Karte; nicht dehnbar; unbedruckt; aufrastbar

[www.wago.com/248-501/000-012](http://www.wago.com/248-501/000-012)



**Art-Nr.: 248-501/000-017**

Mini-WSB-Beschriftungskarte; als Karte; nicht dehnbar; unbedruckt; aufrastbar

[www.wago.com/248-501/000-017](http://www.wago.com/248-501/000-017)



**Art-Nr.: 248-501/000-023**

Mini-WSB-Beschriftungskarte; als Karte; nicht dehnbar; unbedruckt; aufrastbar

[www.wago.com/248-501/000-023](http://www.wago.com/248-501/000-023)



**Art-Nr.: 248-501/000-024**

Mini-WSB-Beschriftungskarte; als Karte; nicht dehnbar; unbedruckt; aufrastbar

[www.wago.com/248-501/000-024](http://www.wago.com/248-501/000-024)



**Art-Nr.: 793-501**

WMB-Beschriftungskarte; als Karte; nicht dehnbar; unbedruckt; aufrastbar

[www.wago.com/793-501](http://www.wago.com/793-501)



**Art-Nr.: 793-501/000-002**

WMB-Beschriftungskarte; als Karte; nicht dehnbar; unbedruckt; aufrastbar

[www.wago.com/793-501/000-002](http://www.wago.com/793-501/000-002)



**Art-Nr.: 793-501/000-005**

WMB-Beschriftungskarte; als Karte; nicht dehnbar; unbedruckt; aufrastbar

[www.wago.com/793-501/000-005](http://www.wago.com/793-501/000-005)



**Art-Nr.: 793-501/000-006**

WMB-Beschriftungskarte; als Karte; nicht dehnbar; unbedruckt; aufrastbar

[www.wago.com/793-501/000-006](http://www.wago.com/793-501/000-006)



**Art-Nr.: 793-501/000-007**

WMB-Beschriftungskarte; als Karte; nicht dehnbar; unbedruckt; aufrastbar

[www.wago.com/793-501/000-007](http://www.wago.com/793-501/000-007)



**Art-Nr.: 793-501/000-012**

WMB-Beschriftungskarte; als Karte; nicht dehnbar; unbedruckt; aufrastbar

[www.wago.com/793-501/000-012](http://www.wago.com/793-501/000-012)



**Art-Nr.: 793-501/000-017**  
WMB-Beschriftungskarte; als Karte; nicht dehnbar; unbedruckt; aufrastbar

[www.wago.com/793-501/000-017](http://www.wago.com/793-501/000-017)



**Art-Nr.: 793-501/000-023**  
WMB-Beschriftungskarte; als Karte; nicht dehnbar; unbedruckt; aufrastbar

[www.wago.com/793-501/000-023](http://www.wago.com/793-501/000-023)



**Art-Nr.: 793-501/000-024**  
WMB-Beschriftungskarte; als Karte; nicht dehnbar; unbedruckt; aufrastbar

[www.wago.com/793-501/000-024](http://www.wago.com/793-501/000-024)



**Art-Nr.: 793-5501**  
WMB-Beschriftungskarte; als Karte; für Klemmenbreite 5 - 17,5 mm; dehnbar 5 - 5,2 mm; unbedruckt; aufrastbar

[www.wago.com/793-5501](http://www.wago.com/793-5501)



**Art-Nr.: 793-5501/000-002**  
WMB-Beschriftungskarte; als Karte; für Klemmenbreite 5 - 17,5 mm; dehnbar 5 - 5,2 mm; unbedruckt; aufrastbar

[www.wago.com/793-5501/000-002](http://www.wago.com/793-5501/000-002)



**Art-Nr.: 793-5501/000-005**  
WMB-Beschriftungskarte; als Karte; dehnbar 5 - 5,2 mm; unbedruckt; aufrastbar

[www.wago.com/793-5501/000-005](http://www.wago.com/793-5501/000-005)



**Art-Nr.: 793-5501/000-006**  
WMB-Beschriftungskarte; als Karte; dehnbar 5 - 5,2 mm; unbedruckt; aufrastbar

[www.wago.com/793-5501/000-006](http://www.wago.com/793-5501/000-006)



**Art-Nr.: 793-5501/000-007**  
WMB-Beschriftungskarte; als Karte; dehnbar 5 - 5,2 mm; unbedruckt; aufrastbar

[www.wago.com/793-5501/000-007](http://www.wago.com/793-5501/000-007)



**Art-Nr.: 793-5501/000-012**  
WMB-Beschriftungskarte; als Karte; dehnbar 5 - 5,2 mm; unbedruckt; aufrastbar

[www.wago.com/793-5501/000-012](http://www.wago.com/793-5501/000-012)



**Art-Nr.: 793-5501/000-017**  
WMB-Beschriftungskarte; als Karte; dehnbar 5 - 5,2 mm; unbedruckt; aufrastbar

[www.wago.com/793-5501/000-017](http://www.wago.com/793-5501/000-017)



**Art-Nr.: 793-5501/000-023**  
WMB-Beschriftungskarte; als Karte; dehnbar 5 - 5,2 mm; unbedruckt; aufrastbar

[www.wago.com/793-5501/000-023](http://www.wago.com/793-5501/000-023)



**Art-Nr.: 793-5501/000-024**  
WMB-Beschriftungskarte; als Karte; dehnbar 5 - 5,2 mm; unbedruckt; aufrastbar

[www.wago.com/793-5501/000-024](http://www.wago.com/793-5501/000-024)

## Brücker



**Art-Nr.: 2002-400**  
Querbrücker für Endlosbrückung; isoliert; 2-fach; Nennstrom 25 A

[www.wago.com/2002-400](http://www.wago.com/2002-400)



















**Art-Nr.: 2002-402**  
Kammbrücker; isoliert; 2-fach; Nennstrom 25 A

















[www.wago.com/2002-402](http://www.wago.com/2002-402)

















**Art-Nr.: 2002-402/000-005**  
Kammbrücker; isoliert; 2-fach; Nennstrom 25 A

[www.wago.com/2002-402/000-005](http://www.wago.com/2002-402/000-005)

	<b>Art-Nr.: 2002-402/000-006</b> Kammbrücke; isoliert; 2-fach; Nennstrom 25 A	<a href="http://www.wago.com/2002-402/000-006">www.wago.com/2002-402/000-006</a>
	<b>Art-Nr.: 2002-403</b> Kammbrücke; isoliert; 3-fach; Nennstrom 25 A	<a href="http://www.wago.com/2002-403">www.wago.com/2002-403</a>
	<b>Art-Nr.: 2002-403/000-005</b> Kammbrücke; isoliert; 3-fach; Nennstrom 25 A	<a href="http://www.wago.com/2002-403/000-005">www.wago.com/2002-403/000-005</a>
	<b>Art-Nr.: 2002-403/000-006</b> Kammbrücke; isoliert; 3-fach; Nennstrom 25 A	<a href="http://www.wago.com/2002-403/000-006">www.wago.com/2002-403/000-006</a>
	<b>Art-Nr.: 2002-404</b> Kammbrücke; isoliert; 4-fach; Nennstrom 25 A	<a href="http://www.wago.com/2002-404">www.wago.com/2002-404</a>
	<b>Art-Nr.: 2002-404/000-005</b> Kammbrücke; isoliert; 4-fach; Nennstrom 25 A	<a href="http://www.wago.com/2002-404/000-005">www.wago.com/2002-404/000-005</a>
	<b>Art-Nr.: 2002-404/000-006</b> Kammbrücke; isoliert; 4-fach; Nennstrom 25 A	<a href="http://www.wago.com/2002-404/000-006">www.wago.com/2002-404/000-006</a>
	<b>Art-Nr.: 2002-405</b> Kammbrücke; isoliert; 5-fach; Nennstrom 25 A	<a href="http://www.wago.com/2002-405">www.wago.com/2002-405</a>
	<b>Art-Nr.: 2002-405/000-005</b> Kammbrücke; isoliert; 5-fach; Nennstrom 25 A	<a href="http://www.wago.com/2002-405/000-005">www.wago.com/2002-405/000-005</a>
	<b>Art-Nr.: 2002-405/000-006</b> Kammbrücke; isoliert; 5-fach; Nennstrom 25 A	<a href="http://www.wago.com/2002-405/000-006">www.wago.com/2002-405/000-006</a>
	<b>Art-Nr.: 2002-405/011-000</b> Sternbrücke; isoliert; 3-fach (1-3-5); IN = IN Klemme	<a href="http://www.wago.com/2002-405/011-000">www.wago.com/2002-405/011-000</a>
	<b>Art-Nr.: 2002-406</b> Kammbrücke; isoliert; 6-fach; Nennstrom 25 A	<a href="http://www.wago.com/2002-406">www.wago.com/2002-406</a>
	<b>Art-Nr.: 2002-406/000-005</b> Kammbrücke; isoliert; 6-fach; Nennstrom 25 A	<a href="http://www.wago.com/2002-406/000-005">www.wago.com/2002-406/000-005</a>
	<b>Art-Nr.: 2002-406/000-006</b> Kammbrücke; isoliert; 6-fach; Nennstrom 25 A	<a href="http://www.wago.com/2002-406/000-006">www.wago.com/2002-406/000-006</a>
	<b>Art-Nr.: 2002-406/020-000</b> Dreieckbrücke; isoliert; 1-2 3-4 5-6; IN = IN Klemme	<a href="http://www.wago.com/2002-406/020-000">www.wago.com/2002-406/020-000</a>
	<b>Art-Nr.: 2002-407</b> Kammbrücke; isoliert; 7-fach; Nennstrom 25 A	<a href="http://www.wago.com/2002-407">www.wago.com/2002-407</a>

	<b>Art-Nr.: 2002-407/000-005</b> Kammbrücker; isoliert; 7-fach; Nennstrom 25 A	<a href="http://www.wago.com/2002-407/000-005">www.wago.com/2002-407/000-005</a>
	<b>Art-Nr.: 2002-407/000-006</b> Kammbrücker; isoliert; 7-fach; Nennstrom 25 A	<a href="http://www.wago.com/2002-407/000-006">www.wago.com/2002-407/000-006</a>
	<b>Art-Nr.: 2002-408</b> Kammbrücker; isoliert; 8-fach; Nennstrom 25 A	<a href="http://www.wago.com/2002-408">www.wago.com/2002-408</a>
	<b>Art-Nr.: 2002-408/000-005</b> Kammbrücker; isoliert; 8-fach; Nennstrom 25 A	<a href="http://www.wago.com/2002-408/000-005">www.wago.com/2002-408/000-005</a>
	<b>Art-Nr.: 2002-408/000-006</b> Kammbrücker; isoliert; 8-fach; Nennstrom 25 A	<a href="http://www.wago.com/2002-408/000-006">www.wago.com/2002-408/000-006</a>
	<b>Art-Nr.: 2002-409</b> Kammbrücker; isoliert; 9-fach; Nennstrom 25 A	<a href="http://www.wago.com/2002-409">www.wago.com/2002-409</a>
	<b>Art-Nr.: 2002-409/000-005</b> Kammbrücker; isoliert; 9-fach; Nennstrom 25 A	<a href="http://www.wago.com/2002-409/000-005">www.wago.com/2002-409/000-005</a>
	<b>Art-Nr.: 2002-409/000-006</b> Kammbrücker; isoliert; 9-fach; Nennstrom 25 A	<a href="http://www.wago.com/2002-409/000-006">www.wago.com/2002-409/000-006</a>
	<b>Art-Nr.: 2002-410</b> Kammbrücker; isoliert; 10-fach; Nennstrom 25 A	<a href="http://www.wago.com/2002-410">www.wago.com/2002-410</a>
	<b>Art-Nr.: 2002-410/000-005</b> Kammbrücker; isoliert; 10-fach; Nennstrom 25 A	<a href="http://www.wago.com/2002-410/000-005">www.wago.com/2002-410/000-005</a>
	<b>Art-Nr.: 2002-410/000-006</b> Kammbrücker; isoliert; 10-fach; Nennstrom 25 A	<a href="http://www.wago.com/2002-410/000-006">www.wago.com/2002-410/000-006</a>
	<b>Art-Nr.: 2002-423</b> Kammbrücker; isoliert; von 1 auf 3; Nennstrom 25 A	<a href="http://www.wago.com/2002-423">www.wago.com/2002-423</a>
	<b>Art-Nr.: 2002-423/000-005</b> Querbrücker für Endlosbrückung; isoliert; von 1 auf 3; Nennstrom 25 A	<a href="http://www.wago.com/2002-423/000-005">www.wago.com/2002-423/000-005</a>
	<b>Art-Nr.: 2002-423/000-006</b> Querbrücker für Endlosbrückung; isoliert; von 1 auf 3; Nennstrom 25 A	<a href="http://www.wago.com/2002-423/000-006">www.wago.com/2002-423/000-006</a>
	<b>Art-Nr.: 2002-433</b> Kammbrücker; isoliert; von 1 auf 3; Nennstrom 25 A	<a href="http://www.wago.com/2002-433">www.wago.com/2002-433</a>
	<b>Art-Nr.: 2002-434</b> Kammbrücker; isoliert; von 1 auf 4; Nennstrom 25 A	<a href="http://www.wago.com/2002-434">www.wago.com/2002-434</a>
	<b>Art-Nr.: 2002-435</b>	

	Kammbrücke; isoliert; von 1 auf 5; Nennstrom 25 A	<a href="http://www.wago.com/2002-435">www.wago.com/2002-435</a>
	<b>Art-Nr.: 2002-436</b> Kammbrücke; isoliert; von 1 auf 6; Nennstrom 25 A	<a href="http://www.wago.com/2002-436">www.wago.com/2002-436</a>
	<b>Art-Nr.: 2002-437</b> Kammbrücke; isoliert; von 1 auf 7; Nennstrom 25 A	<a href="http://www.wago.com/2002-437">www.wago.com/2002-437</a>
	<b>Art-Nr.: 2002-438</b> Kammbrücke; isoliert; von 1 auf 8; Nennstrom 25 A	<a href="http://www.wago.com/2002-438">www.wago.com/2002-438</a>
	<b>Art-Nr.: 2002-439</b> Kammbrücke; isoliert; von 1 auf 9; Nennstrom 25 A	<a href="http://www.wago.com/2002-439">www.wago.com/2002-439</a>
	<b>Art-Nr.: 2002-440</b> Kammbrücke; isoliert; von 1 auf 10; Nennstrom 25 A	<a href="http://www.wago.com/2002-440">www.wago.com/2002-440</a>
	<b>Art-Nr.: 2002-472</b> Schachtelbrücke; isoliert; 2-fach; Nennstrom 25 A; passend zu Reihenklemmen der Serien 2002 und 2003	<a href="http://www.wago.com/2002-472">www.wago.com/2002-472</a>
	<b>Art-Nr.: 2002-473</b> Schachtelbrücke; isoliert; 3-fach; Nennstrom 25 A; passend zu Reihenklemmen der Serien 2002 und 2003	<a href="http://www.wago.com/2002-473">www.wago.com/2002-473</a>
	<b>Art-Nr.: 2002-473/011-000</b> Vorkonfektionierter Schachtelbrücke; isoliert; 2-fach (1-3); Nennstrom 25 A; mit werkseitig ausgebrochenen Zinken und Schaltungsbedruckung	<a href="http://www.wago.com/2002-473/011-000">www.wago.com/2002-473/011-000</a>
	<b>Art-Nr.: 2002-474</b> Schachtelbrücke; isoliert; 4-fach; Nennstrom 25 A; passend zu Reihenklemmen der Serien 2002 und 2003	<a href="http://www.wago.com/2002-474">www.wago.com/2002-474</a>
	<b>Art-Nr.: 2002-475</b> Schachtelbrücke; isoliert; 5-fach; Nennstrom 25 A; passend zu Reihenklemmen der Serien 2002 und 2003	<a href="http://www.wago.com/2002-475">www.wago.com/2002-475</a>
	<b>Art-Nr.: 2002-475/011-000</b> Vorkonfektionierter Schachtelbrücke; isoliert; 3-fach (1-3-5); Nennstrom 25 A; mit werkseitig ausgebrochenen Zinken und Schaltungsbedruckung	<a href="http://www.wago.com/2002-475/011-000">www.wago.com/2002-475/011-000</a>
	<b>Art-Nr.: 2002-476</b> Schachtelbrücke; isoliert; 6-fach; Nennstrom 25 A; passend zu Reihenklemmen der Serien 2002 und 2003	<a href="http://www.wago.com/2002-476">www.wago.com/2002-476</a>
	<b>Art-Nr.: 2002-477</b> Schachtelbrücke; isoliert; 7-fach; Nennstrom 25 A; passend zu Reihenklemmen der Serien 2002 und 2003	<a href="http://www.wago.com/2002-477">www.wago.com/2002-477</a>
	<b>Art-Nr.: 2002-477/011-000</b> Vorkonfektionierter Schachtelbrücke; isoliert; 1-3-5-7; Nennstrom 25 A; mit werkseitig ausgebrochenen Zinken und Schaltungsbedruckung	<a href="http://www.wago.com/2002-477/011-000">www.wago.com/2002-477/011-000</a>
	<b>Art-Nr.: 2002-478</b> Schachtelbrücke; isoliert; 8-fach; Nennstrom 25 A; passend zu Reihenklemmen der Serien 2002 und 2003	<a href="http://www.wago.com/2002-478">www.wago.com/2002-478</a>
	<b>Art-Nr.: 2002-479</b> Schachtelbrücke; isoliert; 9-fach; Nennstrom 25 A; passend zu Reihenklemmen der Serien 2002 und 2003	<a href="http://www.wago.com/2002-479">www.wago.com/2002-479</a>
	<b>Art-Nr.: 2002-479/011-000</b>	

Vorkonfektionierter Schachtelbrücker; isoliert; 1-3-5-7-9; Nennstrom 25 A; mit werkseitig ausgebrochenen Zinken und Schaltungsbedruckung

[www.wago.com/2002-479/011-000](http://www.wago.com/2002-479/011-000)



**Art-Nr.: 2002-480**

Schachtelbrücker; isoliert; 10-fach; Nennstrom 25 A; passend zu Reihenklemmen der Serien 2002 und 2003

[www.wago.com/2002-480](http://www.wago.com/2002-480)



**Art-Nr.: 2002-481**

Schachtelbrücker; isoliert; 11-fach; Nennstrom 25 A; passend zu Reihenklemmen der Serien 2002 und 2003

[www.wago.com/2002-481](http://www.wago.com/2002-481)

**Art-Nr.: 2002-481/011-000**

Vorkonfektionierter Schachtelbrücker; isoliert; 1-3-5-7-9-11; Nennstrom 25 A; mit werkseitig ausgebrochenen Zinken und Schaltungsbedruckung

[www.wago.com/2002-481/011-000](http://www.wago.com/2002-481/011-000)



**Art-Nr.: 2002-482**

Schachtelbrücker; isoliert; 12-fach; Nennstrom 25 A; passend zu Reihenklemmen der Serien 2002 und 2003

[www.wago.com/2002-482](http://www.wago.com/2002-482)



**Art-Nr.: 2006-499**

Reduzierbrücker; isoliert; von 6/4 mm<sup>2</sup> auf 4/2,5/1,5 mm<sup>2</sup>; Nennstrom 32 A

[www.wago.com/2006-499](http://www.wago.com/2006-499)



**Art-Nr.: 2009-412**

Steckbarer Leitungsbrücker; isoliert; L = 60 mm; Leitungsquerschnitt 1,5 mm<sup>2</sup>; passend zu Reihenklemmen der Serien 2001, 2002, 2003 und 2022

[www.wago.com/2009-412](http://www.wago.com/2009-412)



**Art-Nr.: 2009-414**

Steckbarer Leitungsbrücker; isoliert; L = 110 mm; Leitungsquerschnitt 1,5 mm<sup>2</sup>; passend zu Reihenklemmen der Serien 2001, 2002, 2003 und 2022

[www.wago.com/2009-414](http://www.wago.com/2009-414)



**Art-Nr.: 2009-416**

Steckbarer Leitungsbrücker; isoliert; L = 250 mm; Leitungsquerschnitt 1,5 mm<sup>2</sup>; passend zu Reihenklemmen der Serien 2001, 2002, 2003 und 2022

[www.wago.com/2009-416](http://www.wago.com/2009-416)



**Art-Nr.: 2016-499**

Reduzierbrücker; isoliert; von 16/10 mm<sup>2</sup> auf 10/6/4/2,5 mm<sup>2</sup>; Nennstrom 57 A

[www.wago.com/2016-499](http://www.wago.com/2016-499)



**Art-Nr.: 210-103**

Drahtkettenbrücke; isoliert; 50 Anschlüsse

[www.wago.com/210-103](http://www.wago.com/210-103)

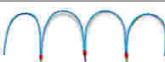

**Art-Nr.: 210-123**

Drahtkettenbrücke; isoliert; 50 Anschlüsse

[www.wago.com/210-123](http://www.wago.com/210-123)

#### Stecker



**Art-Nr.: 2002-880**

Leerstecker; 10,4 mm breit; 2-polig; Typ 4

[www.wago.com/2002-880](http://www.wago.com/2002-880)

#### Isolierungs-Stopp



**Art-Nr.: 2002-171**

Isolierungsstopp; 0,25 - 0,5 mm<sup>2</sup>; 5 Stück / Strang

[www.wago.com/2002-171](http://www.wago.com/2002-171)



**Art-Nr.: 2002-172**

Isolierungsstopp; 0,75 - 1 mm<sup>2</sup>; 5 Stück / Strang

[www.wago.com/2002-172](http://www.wago.com/2002-172)

#### Werkzeug



**Art-Nr.: 210-658**

Betätigungswerkzeug mit teilisoliertem Schaft; Klinge (3,5 x 0,5) mm; kurz; abgewinkelt

[www.wago.com/210-658](http://www.wago.com/210-658)



Art-Nr.: 210-720

Betätigungswerkzeug mit teilisoliertem Schaft; Typ 2, Klinge (3,5 x 0,5) mm

[www.wago.com/210-720](http://www.wago.com/210-720)

## Downloads

### Dokumentation

#### Ausschreibungstext

2002-1202	Aug 13, 2018	DOCX	Download
Reihenklemmen, TOPJOB S		15,0 kB	

## smartDATA

### CAD Daten

3D Download 2002-1202	URL	Download
-----------------------	-----	----------

## Produktfamilie

### TOPJOB S

TOPJOB® S: Das breite und flexible Produktprogramm an Reihenklemmen bietet in diversen Industrieanwendungen und in der modernen Gebäudeinstallation mehr als nur eine sichere elektrische Verbindung.

[Mehr über die Produktfamilie erfahren](#)

[Alle Produkte der Familie anzeigen](#)

Änderungen vorbehalten.

WAGO Kontakttechnik GmbH & Co. KG  
Hansastr. 27  
32423 Minden  
Telefon: +49571 887-0  
E-Mail: [info.de@wago.com](mailto:info.de@wago.com) | Web: [www.wago.com](http://www.wago.com)

Haben Sie Fragen zu unseren Produkten?  
Wir stehen Ihnen telefonisch unter +49 (571) 887-44222 gern zur Verfügung.