

Datenblatt | Artikelnummer: 2002-1406

4-Leiter-Durchgangsklemme; 2,5 mm²; für Anwendungen Ex e II geeignet;
seitliche und mittige Beschriftung; für Tragschiene 35 x 15 und 35 x 7,5;
Push-in CAGE CLAMP®

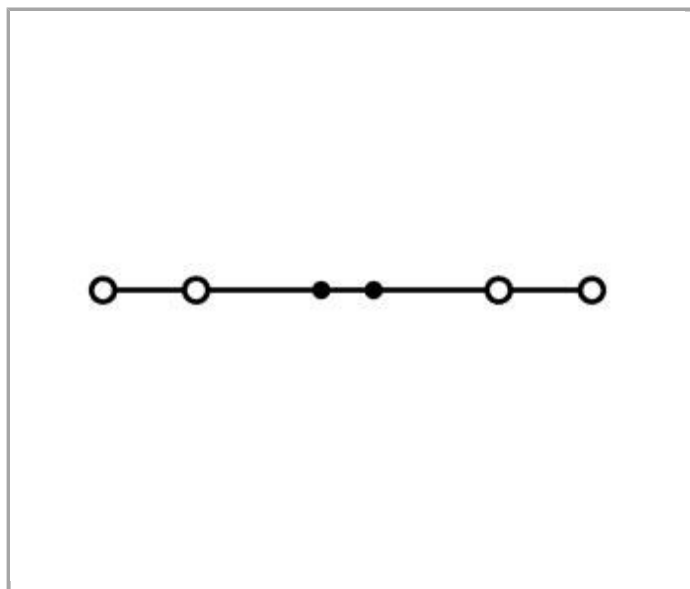

www.wago.com/2002-1406

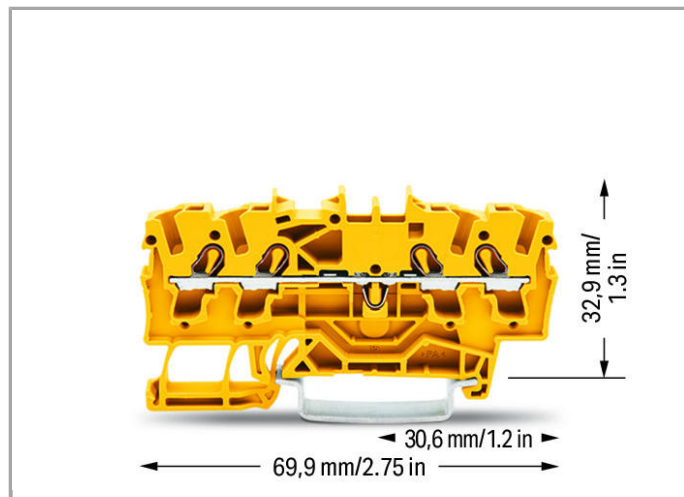
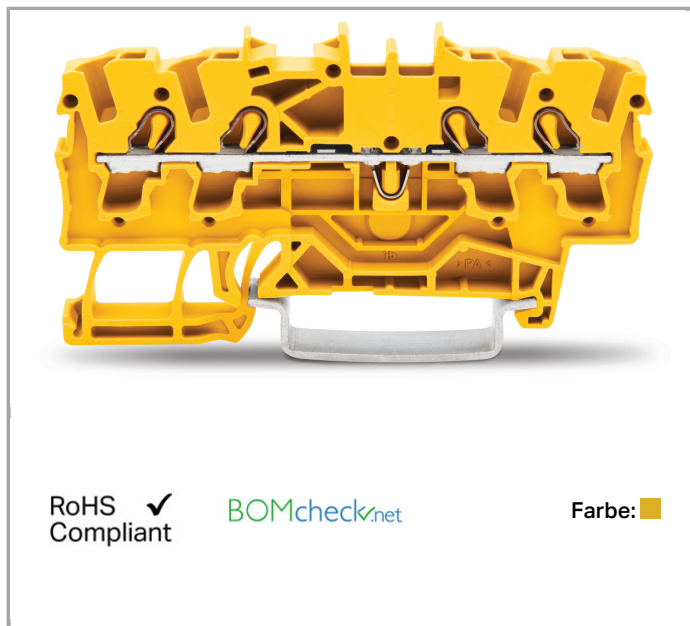

Daten

Elektrische Daten

Bemessungsspannung EN (Ex e II)	550 V
Bemessungsstrom (Ex e II)	22 A
Bemessungsstrom (Ex e II) mit Brücke	20 A

Bemessungsdaten gemäß IEC/EN 60664-1

Bemessungsspannung (III / 3)	800 V
Bemessungsstoßspannung (III / 3)	8 kV
Bemessungsstrom	24 A
Bemessungsstrom 2	32 A
Legende Bemessungsdaten	(III / 3) \triangleq Überspannungskategorie III / Verschmutzungsgrad 3

Bemessungsdaten gemäß UL 1059

Bemessungsspannung UL (Use Group B)	600 V
Bemessungsstrom UL (Use Group B)	20 A
Bemessungsspannung UL (Use Group C)	600 V
Bemessungsstrom UL (Use Group C)	20 A

Bemessungsdaten gemäß CSA

Bemessungsspannung CSA (Use Group B)	600 V
Bemessungsstrom CSA (Use Group B)	20 A
Bemessungsspannung CSA (Use Group C)	600 V
Bemessungsstrom CSA (Use Group C)	20 A

Anschlussdaten

Anschluss technik	Push-in CAGE CLAMP®
Betätigungsart	Push-in Betätigungswerkzeug
Anschließbare Leiterwerkstoffe	Kupfer
Nennquerschnitt	2,5 mm ²
Eindrätiger Leiter	0,25 ... 4 mm ² / 22 ... 12 AWG
Eindrätiger Leiter, direkt steckbar	0,75 ... 4 mm ² / 18 ... 12 AWG
Feindrätiger Leiter	0,25 ... 4 mm ² / 22 ... 12 AWG
Feindrätiger Leiter; mit Aderendhülse, direkt steckbar ab	0,75 mm ² / 18 AWG
Abisolierlänge	10 ... 12 mm / 0.39 ... 0.47 inch
Gesamte Anzahl der Klemmstellen	4
Gesamte Anzahl der Potentiale	1
Anzahl der Ebenen	1
Verdrahtungsart	Frontverdrahtung

Geometrische Daten

Breite	5,2 mm / 0.205 inch
Höhe ab Oberkante Tragschiene	32,9 mm / 1.295 inch
Tiefe	69,9 mm / 2.752 inch

Mechanische Daten

Bauform	horizontale Bauform
Montageart	Tragschiene 35
Beschriftungsebene	Mitten-/Seitliche Beschriftung

Werkstoffdaten

Farbe	gelb
Isolierwerkstoff	Polyamid 66 (PA 66)
Brandlast	0.122 MJ
Gewicht	6.382 g

Kaufmännische Daten

Ursprungsland	DE
GTIN	4044918081573
Zolltarifnummer	85369010000
Produktgruppe	22 (TOPJOB S Reihenklemmen)
eCl@ss 9.0	27-14-11-20
eCl@ss 8.0	27-14-11-20
ETIM 6.0	EC000897
ETIM 5.0	EC000897





Zulassungen / Zertifikate

Ex-Zulassungen





Logo	Zulassung	Zertifikatsname
	AEx UL International Germany GmbH c/o Physikalisch Technische Bundesanstalt	E185892 sec.7
	AEx UL International Germany GmbH c/o Physikalisch Technische Bundesanstalt	E185892 sec.7
	ATEX Physikalisch Technische Bundesanstalt (PTB)	PTB 03 ATEX 1162 U (II 2 G/D Ex e II bzw. I M 2 Ex e I)
	IECEX Physikalisch Technische Bundesanstalt	IECEX PTB 03.0004U

Länderspezifische Zulassungen

Logo	Zulassung	Zertifikatsname
------	-----------	-----------------

	CCA DEKRA Certification B.V.	NTR NL 7585
	CSA DEKRA Certification B.V.	1536069
	CSA DEKRA Certification B.V.	1536069
	KEMA/KEUR DEKRA Certification B.V.	2198985.01

Schiff Zulassungen















Logo	Zulassung	Zertifikatsname
	ABS American Bureau of Shipping	14-HG1293677-PDA
	BV Bureau Veritas S.A.	38586/A0 BV
	DNV GL Det Norske Veritas, Germanischer Lloyd	TAE00001V2
	LR Lloyds Register	91/20112 (E9)

UL-Zulassungen





Logo	Zulassung	Zertifikatsname
	cURus Underwriters Laboratories Inc.	E45172















Passende Produkte

















Prüfen und Messen

	Art-Nr.: 2002-511 Modularer TOPJOB®S-Steckverbinder; anreihbar; für Brückerschlitze; 1-polig	www.wago.com/2002-511
	Art-Nr.: 2002-549 Blindmodul; anreihbar; zum Überspringen von z. B. gebrückten Klemmen	www.wago.com/2002-549
	Art-Nr.: 2002-552 TOPJOB®S-Steckverbinderleiste; für Brückerschlitze; 2-polig	www.wago.com/2002-552
	Art-Nr.: 2002-553 TOPJOB®S-Steckverbinderleiste; für Brückerschlitze; 3-polig	www.wago.com/2002-553
	Art-Nr.: 2002-554 TOPJOB®S-Steckverbinderleiste; für Brückerschlitze; 4-polig	www.wago.com/2002-554
	Art-Nr.: 2002-555 TOPJOB®S-Steckverbinderleiste; für Brückerschlitze; 5-polig	www.wago.com/2002-555
	Art-Nr.: 2002-556 TOPJOB®S-Steckverbinderleiste; für Brückerschlitze; 6-polig	www.wago.com/2002-556
	Art-Nr.: 2002-557 TOPJOB®S-Steckverbinderleiste; für Brückerschlitze; 7-polig	www.wago.com/2002-557
	Art-Nr.: 2002-558 TOPJOB®S-Steckverbinderleiste; für Brückerschlitze; 8-polig	www.wago.com/2002-558
	Art-Nr.: 2002-559 TOPJOB®S-Steckverbinderleiste; für Brückerschlitze; 9-polig	www.wago.com/2002-559
	Art-Nr.: 2002-560 TOPJOB®S-Steckverbinderleiste; für Brückerschlitze; 10-polig	www.wago.com/2002-560
	Art-Nr.: 2002-611 TOPJOB®S-L-Prüfsteckermodul; anreihbar; 1-polig	www.wago.com/2002-611
	Art-Nr.: 2002-649 TOPJOB®S-L-Blindmodul; anreihbar; zum Überspringen von z. B. gebrückten Klemmen	www.wago.com/2002-649
	Art-Nr.: 2009-174 Prüfadapter; für Prüfstecker Ø 4 mm; zur Prüfung von TOPJOB®S-Reihenklemmen	www.wago.com/2009-174
	Art-Nr.: 2009-182 Prüfabgriff; für max. 2,5 mm ² ; für den werkzeuglosen Anschluss individueller Prüfleitungen von 0,08 mm - 2,5 mm	www.wago.com/2009-182

Beschriftungsmaterial

	Art-Nr.: 2002-161 Adapter	www.wago.com/2002-161
	Art-Nr.: 2009-110 Beschriftungsstreifen; auf Rolle; nicht dehnbar; unbedruckt; aufrastbar	www.wago.com/2009-110
	Art-Nr.: 2009-115 WMB-Inline; für smartPRINTER; auf Rolle; dehnbar 5 - 5,2 mm; unbedruckt; aufrastbar	www.wago.com/2009-115
	Art-Nr.: 2009-115/000-002 WMB-Inline; für smartPRINTER; auf Rolle; dehnbar 5 - 5,2 mm; unbedruckt; aufrastbar	www.wago.com/2009-115/000-002

	Art-Nr.: 2009-115/000-006 WMB-Inline; für smartPRINTER; auf Rolle; dehnbar 5 - 5,2 mm; unbedruckt; aufrastbar	www.wago.com/2009-115/000-006
	Art-Nr.: 2009-115/000-007 WMB-Inline; für smartPRINTER; auf Rolle; dehnbar 5 - 5,2 mm; unbedruckt; aufrastbar	www.wago.com/2009-115/000-007
	Art-Nr.: 2009-115/000-012 WMB-Inline; für smartPRINTER; auf Rolle; dehnbar 5 - 5,2 mm; unbedruckt; aufrastbar	www.wago.com/2009-115/000-012
	Art-Nr.: 2009-115/000-017 WMB-Inline; für smartPRINTER; auf Rolle; dehnbar 5 - 5,2 mm; unbedruckt; aufrastbar	www.wago.com/2009-115/000-017
	Art-Nr.: 2009-115/000-023 WMB-Inline; für smartPRINTER; auf Rolle; dehnbar 5 - 5,2 mm; unbedruckt; aufrastbar	www.wago.com/2009-115/000-023
	Art-Nr.: 2009-115/000-024 WMB-Inline; für smartPRINTER; auf Rolle; dehnbar 5 - 5,2 mm; unbedruckt; aufrastbar	www.wago.com/2009-115/000-024
	Art-Nr.: 2009-145 Mini-WSB Inline; für smartPRINTER; auf Rolle; dehnbar 5 - 5,2 mm; unbedruckt; aufrastbar	www.wago.com/2009-145
	Art-Nr.: 2009-145/000-002 Mini-WSB Inline; für smartPRINTER; auf Rolle; dehnbar 5 - 5,2 mm; unbedruckt; aufrastbar	www.wago.com/2009-145/000-002
	Art-Nr.: 2009-145/000-005 Mini-WSB Inline; für smartPRINTER; auf Rolle; dehnbar 5 - 5,2 mm; unbedruckt; aufrastbar	www.wago.com/2009-145/000-005
	Art-Nr.: 2009-145/000-006 Mini-WSB Inline; für smartPRINTER; auf Rolle; dehnbar 5 - 5,2 mm; unbedruckt; aufrastbar	www.wago.com/2009-145/000-006
	Art-Nr.: 2009-145/000-007 Mini-WSB Inline; für smartPRINTER; auf Rolle; dehnbar 5 - 5,2 mm; unbedruckt; aufrastbar	www.wago.com/2009-145/000-007
	Art-Nr.: 2009-145/000-012 Mini-WSB Inline; für smartPRINTER; auf Rolle; dehnbar 5 - 5,2 mm; unbedruckt; aufrastbar	www.wago.com/2009-145/000-012
	Art-Nr.: 2009-145/000-023 Mini-WSB Inline; für smartPRINTER; auf Rolle; dehnbar 5 - 5,2 mm; unbedruckt; aufrastbar	www.wago.com/2009-145/000-023
	Art-Nr.: 2009-145/000-024 Mini-WSB Inline; auf Rolle; dehnbar 5 - 5,2 mm; unbedruckt; aufrastbar	www.wago.com/2009-145/000-024
	Art-Nr.: 2009-191 Gruppenschildträger	www.wago.com/2009-191

	Art-Nr.: 2009-192 Gruppenschildträger	www.wago.com/2009-192
	Art-Nr.: 2009-193 Gruppenschildträger	www.wago.com/2009-193
	Art-Nr.: 2009-198 Adapter	www.wago.com/2009-198
	Art-Nr.: 248-501 Mini-WSB-Schnellbeschriftungssystem; unbedruckt; Schildchenbreite 5 mm; 10 Streifen à 10 Schilder pro Karte	www.wago.com/248-501
	Art-Nr.: 248-501/000-002 Mini-WSB-Beschriftungskarte; als Karte; nicht dehnbar; unbedruckt; aufrastbar	www.wago.com/248-501/000-002
	Art-Nr.: 248-501/000-005 Mini-WSB-Beschriftungskarte; als Karte; unbedruckt; aufrastbar	www.wago.com/248-501/000-005
	Art-Nr.: 248-501/000-006 Mini-WSB-Beschriftungskarte; als Karte; nicht dehnbar; unbedruckt; aufrastbar	www.wago.com/248-501/000-006
	Art-Nr.: 248-501/000-007 Mini-WSB-Beschriftungskarte; als Karte; nicht dehnbar; unbedruckt; aufrastbar	www.wago.com/248-501/000-007
	Art-Nr.: 248-501/000-012 Mini-WSB-Beschriftungskarte; als Karte; nicht dehnbar; unbedruckt; aufrastbar	www.wago.com/248-501/000-012
	Art-Nr.: 248-501/000-017 Mini-WSB-Beschriftungskarte; als Karte; nicht dehnbar; unbedruckt; aufrastbar	www.wago.com/248-501/000-017
	Art-Nr.: 248-501/000-023 Mini-WSB-Beschriftungskarte; als Karte; nicht dehnbar; unbedruckt; aufrastbar	www.wago.com/248-501/000-023
	Art-Nr.: 248-501/000-024 Mini-WSB-Beschriftungskarte; als Karte; nicht dehnbar; unbedruckt; aufrastbar	www.wago.com/248-501/000-024
	Art-Nr.: 793-501 WMB-Beschriftungskarte; als Karte; nicht dehnbar; unbedruckt; aufrastbar	www.wago.com/793-501
	Art-Nr.: 793-501/000-002 WMB-Beschriftungskarte; als Karte; nicht dehnbar; unbedruckt; aufrastbar	www.wago.com/793-501/000-002
	Art-Nr.: 793-501/000-005 WMB-Beschriftungskarte; als Karte; nicht dehnbar; unbedruckt; aufrastbar	www.wago.com/793-501/000-005
	Art-Nr.: 793-501/000-006 WMB-Beschriftungskarte; als Karte; nicht dehnbar; unbedruckt; aufrastbar	www.wago.com/793-501/000-006



Art-Nr.: 793-501/000-007
WMB-Beschriftungskarte; als Karte; nicht dehnbar; unbedruckt; aufrastbar

www.wago.com/793-501/000-007



Art-Nr.: 793-501/000-012
WMB-Beschriftungskarte; als Karte; nicht dehnbar; unbedruckt; aufrastbar

www.wago.com/793-501/000-012



Art-Nr.: 793-501/000-017
WMB-Beschriftungskarte; als Karte; nicht dehnbar; unbedruckt; aufrastbar

www.wago.com/793-501/000-017



Art-Nr.: 793-501/000-023
WMB-Beschriftungskarte; als Karte; nicht dehnbar; unbedruckt; aufrastbar

www.wago.com/793-501/000-023



Art-Nr.: 793-501/000-024
WMB-Beschriftungskarte; als Karte; nicht dehnbar; unbedruckt; aufrastbar

www.wago.com/793-501/000-024



Art-Nr.: 793-5501
WMB-Beschriftungskarte; als Karte; für Klemmenbreite 5 - 17,5 mm; dehnbar 5 - 5,2 mm; unbedruckt; aufrastbar

www.wago.com/793-5501



Art-Nr.: 793-5501/000-002
WMB-Beschriftungskarte; als Karte; für Klemmenbreite 5 - 17,5 mm; dehnbar 5 - 5,2 mm; unbedruckt; aufrastbar

www.wago.com/793-5501/000-002



Art-Nr.: 793-5501/000-005
WMB-Beschriftungskarte; als Karte; dehnbar 5 - 5,2 mm; unbedruckt; aufrastbar

www.wago.com/793-5501/000-005



Art-Nr.: 793-5501/000-006
WMB-Beschriftungskarte; als Karte; dehnbar 5 - 5,2 mm; unbedruckt; aufrastbar

www.wago.com/793-5501/000-006



Art-Nr.: 793-5501/000-007
WMB-Beschriftungskarte; als Karte; dehnbar 5 - 5,2 mm; unbedruckt; aufrastbar

www.wago.com/793-5501/000-007



Art-Nr.: 793-5501/000-012
WMB-Beschriftungskarte; als Karte; dehnbar 5 - 5,2 mm; unbedruckt; aufrastbar

www.wago.com/793-5501/000-012



Art-Nr.: 793-5501/000-017
WMB-Beschriftungskarte; als Karte; dehnbar 5 - 5,2 mm; unbedruckt; aufrastbar

www.wago.com/793-5501/000-017



Art-Nr.: 793-5501/000-023
WMB-Beschriftungskarte; als Karte; dehnbar 5 - 5,2 mm; unbedruckt; aufrastbar

















www.wago.com/793-5501/000-023





















Art-Nr.: 793-5501/000-024
WMB-Beschriftungskarte; als Karte; dehnbar 5 - 5,2 mm; unbedruckt; aufrastbar













www.wago.com/793-5501/000-024





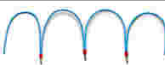

Brücker

	Art-Nr.: 2002-400 Querbrücker für Endlosbrückung; isoliert; 2-fach; Nennstrom 25 A	www.wago.com/2002-400
	Art-Nr.: 2002-402 Kammbrücker; isoliert; 2-fach; Nennstrom 25 A	www.wago.com/2002-402
	Art-Nr.: 2002-402/000-005 Kammbrücker; isoliert; 2-fach; Nennstrom 25 A	www.wago.com/2002-402/000-005
	Art-Nr.: 2002-402/000-006 Kammbrücker; isoliert; 2-fach; Nennstrom 25 A	www.wago.com/2002-402/000-006
	Art-Nr.: 2002-403 Kammbrücker; isoliert; 3-fach; Nennstrom 25 A	www.wago.com/2002-403
	Art-Nr.: 2002-403/000-005 Kammbrücker; isoliert; 3-fach; Nennstrom 25 A	www.wago.com/2002-403/000-005
	Art-Nr.: 2002-403/000-006 Kammbrücker; isoliert; 3-fach; Nennstrom 25 A	www.wago.com/2002-403/000-006
	Art-Nr.: 2002-404 Kammbrücker; isoliert; 4-fach; Nennstrom 25 A	www.wago.com/2002-404
	Art-Nr.: 2002-404/000-005 Kammbrücker; isoliert; 4-fach; Nennstrom 25 A	www.wago.com/2002-404/000-005
	Art-Nr.: 2002-404/000-006 Kammbrücker; isoliert; 4-fach; Nennstrom 25 A	www.wago.com/2002-404/000-006
	Art-Nr.: 2002-405 Kammbrücker; isoliert; 5-fach; Nennstrom 25 A	www.wago.com/2002-405
	Art-Nr.: 2002-405/000-005 Kammbrücker; isoliert; 5-fach; Nennstrom 25 A	www.wago.com/2002-405/000-005
	Art-Nr.: 2002-405/000-006 Kammbrücker; isoliert; 5-fach; Nennstrom 25 A	www.wago.com/2002-405/000-006
	Art-Nr.: 2002-405/011-000 Sternbrücker; isoliert; 3-fach (1-3-5); IN = IN Klemme	www.wago.com/2002-405/011-000
	Art-Nr.: 2002-406 Kammbrücker; isoliert; 6-fach; Nennstrom 25 A	www.wago.com/2002-406
	Art-Nr.: 2002-406/000-005 Kammbrücker; isoliert; 6-fach; Nennstrom 25 A	www.wago.com/2002-406/000-005



	Art-Nr.: 2002-406/000-006 Kammbrücker; isoliert; 6-fach; Nennstrom 25 A	www.wago.com/2002-406/000-006
	Art-Nr.: 2002-406/020-000 Dreieckbrücker; isoliert; 1-2 3-4 5-6; IN = IN Klemme	www.wago.com/2002-406/020-000
	Art-Nr.: 2002-407 Kammbrücker; isoliert; 7-fach; Nennstrom 25 A	www.wago.com/2002-407
	Art-Nr.: 2002-407/000-005 Kammbrücker; isoliert; 7-fach; Nennstrom 25 A	www.wago.com/2002-407/000-005
	Art-Nr.: 2002-407/000-006 Kammbrücker; isoliert; 7-fach; Nennstrom 25 A	www.wago.com/2002-407/000-006
	Art-Nr.: 2002-408 Kammbrücker; isoliert; 8-fach; Nennstrom 25 A	www.wago.com/2002-408
	Art-Nr.: 2002-408/000-005 Kammbrücker; isoliert; 8-fach; Nennstrom 25 A	www.wago.com/2002-408/000-005
	Art-Nr.: 2002-408/000-006 Kammbrücker; isoliert; 8-fach; Nennstrom 25 A	www.wago.com/2002-408/000-006
	Art-Nr.: 2002-409 Kammbrücker; isoliert; 9-fach; Nennstrom 25 A	www.wago.com/2002-409
	Art-Nr.: 2002-409/000-005 Kammbrücker; isoliert; 9-fach; Nennstrom 25 A	www.wago.com/2002-409/000-005
	Art-Nr.: 2002-409/000-006 Kammbrücker; isoliert; 9-fach; Nennstrom 25 A	www.wago.com/2002-409/000-006
	Art-Nr.: 2002-410 Kammbrücker; isoliert; 10-fach; Nennstrom 25 A	www.wago.com/2002-410
	Art-Nr.: 2002-410/000-005 Kammbrücker; isoliert; 10-fach; Nennstrom 25 A	www.wago.com/2002-410/000-005
	Art-Nr.: 2002-410/000-006 Kammbrücker; isoliert; 10-fach; Nennstrom 25 A	www.wago.com/2002-410/000-006
	Art-Nr.: 2002-423 Kammbrücker; isoliert; von 1 auf 3; Nennstrom 25 A	www.wago.com/2002-423
	Art-Nr.: 2002-423/000-005 Querbrücker für Endlosbrückung; isoliert; von 1 auf 3; Nennstrom 25 A	www.wago.com/2002-423/000-005

	Art-Nr.: 2002-423/000-006 Querbrücker für Endlosbrückung; isoliert; von 1 auf 3; Nennstrom 25 A	www.wago.com/2002-423/000-006
	Art-Nr.: 2002-433 Kammbrücker; isoliert; von 1 auf 3; Nennstrom 25 A	www.wago.com/2002-433
	Art-Nr.: 2002-434 Kammbrücker; isoliert; von 1 auf 4; Nennstrom 25 A	www.wago.com/2002-434
	Art-Nr.: 2002-435 Kammbrücker; isoliert; von 1 auf 5; Nennstrom 25 A	www.wago.com/2002-435
	Art-Nr.: 2002-436 Kammbrücker; isoliert; von 1 auf 6; Nennstrom 25 A	www.wago.com/2002-436
	Art-Nr.: 2002-437 Kammbrücker; isoliert; von 1 auf 7; Nennstrom 25 A	www.wago.com/2002-437
	Art-Nr.: 2002-438 Kammbrücker; isoliert; von 1 auf 8; Nennstrom 25 A	www.wago.com/2002-438
	Art-Nr.: 2002-439 Kammbrücker; isoliert; von 1 auf 9; Nennstrom 25 A	www.wago.com/2002-439
	Art-Nr.: 2002-440 Kammbrücker; isoliert; von 1 auf 10; Nennstrom 25 A	www.wago.com/2002-440
	Art-Nr.: 2002-472 Schachtelbrücker; isoliert; 2-fach; Nennstrom 25 A; passend zu Reihenklennen der Serien 2002 und 2003	www.wago.com/2002-472
	Art-Nr.: 2002-473 Schachtelbrücker; isoliert; 3-fach; Nennstrom 25 A; passend zu Reihenklennen der Serien 2002 und 2003	www.wago.com/2002-473
	Art-Nr.: 2002-473/011-000 Vorkonfektionierter Schachtelbrücker; isoliert; 2-fach (1-3); Nennstrom 25 A; mit werkseitig ausgebrochenen Zinken und Schaltungsbedruckung	www.wago.com/2002-473/011-000
	Art-Nr.: 2002-474 Schachtelbrücker; isoliert; 4-fach; Nennstrom 25 A; passend zu Reihenklennen der Serien 2002 und 2003	www.wago.com/2002-474
	Art-Nr.: 2002-475 Schachtelbrücker; isoliert; 5-fach; Nennstrom 25 A; passend zu Reihenklennen der Serien 2002 und 2003	www.wago.com/2002-475
	Art-Nr.: 2002-475/011-000 Vorkonfektionierter Schachtelbrücker; isoliert; 3-fach (1-3-5); Nennstrom 25 A; mit werkseitig ausgebrochenen Zinken und Schaltungsbedruckung	www.wago.com/2002-475/011-000
	Art-Nr.: 2002-476 Schachtelbrücker; isoliert; 6-fach; Nennstrom 25 A; passend zu Reihenklennen der Serien 2002 und 2003	www.wago.com/2002-476
	Art-Nr.: 2002-477 Schachtelbrücker; isoliert; 7-fach; Nennstrom 25 A; passend zu Reihenklennen der Serien 2002 und 2003	www.wago.com/2002-477
	Art-Nr.: 2002-477/011-000 Vorkonfektionierter Schachtelbrücker; isoliert; 1-3-5-7; Nennstrom 25 A; mit werkseitig ausgebrochenen Zinken und Schaltungsbedruckung	www.wago.com/2002-477/011-000

	Art-Nr.: 2002-478 Schachtelbrücker; isoliert; 8-fach; Nennstrom 25 A; passend zu Reihenklemmen der Serien 2002 und 2003	www.wago.com/2002-478
	Art-Nr.: 2002-479 Schachtelbrücker; isoliert; 9-fach; Nennstrom 25 A; passend zu Reihenklemmen der Serien 2002 und 2003	www.wago.com/2002-479
	Art-Nr.: 2002-479/011-000 Vorkonfektionierter Schachtelbrücker; isoliert; 1-3-5-7-9; Nennstrom 25 A; mit werkseitig ausgebrochenen Zinken und Schaltungsbedruckung	www.wago.com/2002-479/011-000
	Art-Nr.: 2002-480 Schachtelbrücker; isoliert; 10-fach; Nennstrom 25 A; passend zu Reihenklemmen der Serien 2002 und 2003	www.wago.com/2002-480
	Art-Nr.: 2002-481 Schachtelbrücker; isoliert; 11-fach; Nennstrom 25 A; passend zu Reihenklemmen der Serien 2002 und 2003	www.wago.com/2002-481
	Art-Nr.: 2002-481/011-000 Vorkonfektionierter Schachtelbrücker; isoliert; 1-3-5-7-9-11; Nennstrom 25 A; mit werkseitig ausgebrochenen Zinken und Schaltungsbedruckung	www.wago.com/2002-481/011-000
	Art-Nr.: 2002-482 Schachtelbrücker; isoliert; 12-fach; Nennstrom 25 A; passend zu Reihenklemmen der Serien 2002 und 2003	www.wago.com/2002-482
	Art-Nr.: 2006-499 Reduzierbrücker; isoliert; von 6/4 mm ² auf 4/2,5/1,5 mm ² ; Nennstrom 32 A	www.wago.com/2006-499
	Art-Nr.: 2009-412 Steckbarer Leitungsbrücker; isoliert; L = 60 mm; Leitungsquerschnitt 1,5 mm ² ; passend zu Reihenklemmen der Serien 2001, 2002, 2003 und 2022	www.wago.com/2009-412
	Art-Nr.: 2009-414 Steckbarer Leitungsbrücker; isoliert; L = 110 mm; Leitungsquerschnitt 1,5 mm ² ; passend zu Reihenklemmen der Serien 2001, 2002, 2003 und 2022	www.wago.com/2009-414
	Art-Nr.: 2009-416 Steckbarer Leitungsbrücker; isoliert; L = 250 mm; Leitungsquerschnitt 1,5 mm ² ; passend zu Reihenklemmen der Serien 2001, 2002, 2003 und 2022	www.wago.com/2009-416
	Art-Nr.: 2016-499 Reduzierbrücker; isoliert; von 16/10 mm ² auf 10/6/4/2,5 mm ² ; Nennstrom 57 A	www.wago.com/2016-499
	Art-Nr.: 210-103 Drahtkettenbrücke; isoliert; 50 Anschlüsse	www.wago.com/210-103
	Art-Nr.: 210-123 Drahtkettenbrücke; isoliert; 50 Anschlüsse	www.wago.com/210-123
Aderendhülse		
	Art-Nr.: 216-241 Aderendhülse; Hülse für 0,5 mm ² / AWG 22; mit Kunststoffkragen; galvanisch verzinkt; Elektrolytkupfer; gasdicht aufgedrimpt; gemäß DIN 46228, Teil 4/09.90	www.wago.com/216-241
	Art-Nr.: 216-242 Aderendhülse; Hülse für 0,75 mm ² / AWG 20; mit Kunststoffkragen; galvanisch verzinkt; Elektrolytkupfer; gasdicht aufgedrimpt; gemäß DIN 46228, Teil 4/09.90	www.wago.com/216-242
	Art-Nr.: 216-243 Aderendhülse; Hülse für 1 mm ² / AWG 18; mit Kunststoffkragen; galvanisch verzinkt; Elektrolytkupfer;	www.wago.com/216-243

	gasdicht aufgecrimpt; gemäß DIN 46228, Teil 4/09.90	
	Art-Nr.: 216-244 Aderendhülse; Hülse für 1,5 mm ² / AWG 16; mit Kunststoffkragen; galvanisch verzinkt; Elektrolytkupfer; gasdicht aufgecrimpt; gemäß DIN 46228, Teil 4/09.90	www.wago.com/216-244
	Art-Nr.: 216-246 Aderendhülse; Hülse für 2,5 mm ² / AWG 14; mit Kunststoffkragen; galvanisch verzinkt; Elektrolytkupfer; gasdicht aufgecrimpt; gemäß DIN 46228, Teil 4/09.90	www.wago.com/216-246
	Art-Nr.: 216-262 Aderendhülse; Hülse für 0,75 mm ² / AWG 20; mit Kunststoffkragen; galvanisch verzinkt; Elektrolytkupfer; gasdicht aufgecrimpt; gemäß DIN 46228, Teil 4/09.90	www.wago.com/216-262
	Art-Nr.: 216-263 Aderendhülse; Hülse für 1 mm ² / AWG 18; mit Kunststoffkragen; galvanisch verzinkt; Elektrolytkupfer; gasdicht aufgecrimpt; gemäß DIN 46228, Teil 4/09.90	www.wago.com/216-263
	Art-Nr.: 216-264 Aderendhülse; Hülse für 1,5 mm ² / AWG 16; mit Kunststoffkragen; galvanisch verzinkt; Elektrolytkupfer; gasdicht aufgecrimpt; gemäß DIN 46228, Teil 4/09.90	www.wago.com/216-264
	Art-Nr.: 216-266 Aderendhülse; Hülse für 2,5 mm ² / AWG 14; mit Kunststoffkragen; galvanisch verzinkt; Elektrolytkupfer; gasdicht aufgecrimpt; gemäß DIN 46228, Teil 4/09.90	www.wago.com/216-266





Isolierungs-Stopp

	Art-Nr.: 2002-171 Isolierungsstopp; 0,25 - 0,5 mm ² ; 5 Stück / Strang	www.wago.com/2002-171
	Art-Nr.: 2002-172 Isolierungsstopp; 0,75 - 1 mm ² ; 5 Stück / Strang	www.wago.com/2002-172

Warnabdeckung

	Art-Nr.: 2002-115 Warnabdeckung; mit schwarzem Blitzpfeil; für 5 Klemmen	www.wago.com/2002-115
--	--	--

Abschlussplatte

	Art-Nr.: 2002-1491 Abschluss- und Zwischenplatte; 0,8 mm dick	www.wago.com/2002-1491
	Art-Nr.: 2002-1492 Abschluss- und Zwischenplatte; 0,8 mm dick	www.wago.com/2002-1492
	Art-Nr.: 2002-1493 Trennwand; 2 mm dick; überstehend	www.wago.com/2002-1493
	Art-Nr.: 2002-1494 Trennwand; 2 mm dick; überstehend	www.wago.com/2002-1494
	Art-Nr.: 209-191 Trennwand Ex e/Ex i; 3 mm dick; 120 mm breit	www.wago.com/209-191

Allgemeines Zubehör

	Art-Nr.: 2002-880/1000-411 Diodenbaustein; mit Diode 1N4007 als Freilaufdiode; 10,4 mm breit; Betriebstemperatur 85 °C max.	www.wago.com/2002-880/1000-411
--	---	--



Art-Nr.: 2002-880/1000-541

LED-Baustein; mit roter LED; 10,4 mm breit; 12 - 30 V; Betriebstemperatur 85 °C max.

www.wago.com/2002-880/1000-541



Art-Nr.: 2002-880/1000-542

LED-Baustein

www.wago.com/2002-880/1000-542



Art-Nr.: 2002-880/1000-836

LED-Baustein; mit roter LED; 10,4 mm breit; 230 V; Betriebstemperatur 85 °C max.

www.wago.com/2002-880/1000-836

Tragschiene



Art-Nr.: 210-112

Stahltragschiene; 35 x 7,5 mm; 1 mm dick; 2 m lang; gelocht; entsprechend EN 60715; Lochbreite 25 mm; Lochabstand 36 mm

www.wago.com/210-112



Art-Nr.: 210-113

Stahltragschiene; 35 x 7,5 mm; 1 mm dick; 2 m lang; ungelocht; entsprechend EN 60715

www.wago.com/210-113



Art-Nr.: 210-114

Stahltragschiene; 35 x 15 mm; 1,5 mm dick; 2 m lang; ungelocht; ähnlich EN 60715

www.wago.com/210-114



Art-Nr.: 210-115

Stahltragschiene; 35 x 7,5 mm; 1 mm dick; 2 m lang; gelocht; entsprechend EN 60715; Lochbreite 18 mm; Lochabstand 25 mm

www.wago.com/210-115



Art-Nr.: 210-118

Stahltragschiene; 35 x 15 mm; 2,3 mm dick; 2 m lang; ungelocht; entsprechend EN 60715

www.wago.com/210-118



Art-Nr.: 210-196

Aluminiumtragschiene; 35 x 8,2 mm; 1,6 mm dick; 2 m lang; ungelocht; ähnlich EN 60715

www.wago.com/210-196



Art-Nr.: 210-197

Stahltragschiene; 35 x 15 mm; 1,5 mm dick; 2 m lang; gelocht; ähnlich EN 60715

www.wago.com/210-197



Art-Nr.: 210-198

Kupfertragschiene; 35 x 15 mm; 2,3 mm dick; 2 m lang; ungelocht; entsprechend EN 60715

www.wago.com/210-198

Werkzeug



Art-Nr.: 210-658

Betätigungswerkzeug mit teilisoliertem Schaft; Klinge (3,5 x 0,5) mm; kurz; abgewinkelt

www.wago.com/210-658



Art-Nr.: 210-720

Betätigungswerkzeug mit teilisoliertem Schaft; Typ 2; Klinge (3,5 x 0,5) mm

www.wago.com/210-720

Stecker



Art-Nr.: 2002-880

Leerstecker; 10,4 mm breit; 2-polig; Typ 4

www.wago.com/2002-880



Downloads

Dokumentation

Ausschreibungstext

2002-1406	Aug 13, 2018	DOCX	Download
Reihenklemmen, TOPJOB S		15,1 kB	

smartDATA

CAD Daten

3D Download 2002-1406		URL	Download
-----------------------	--	-----	----------

Produktfamilie

TOPJOB S

TOPJOB® S: Das breite und flexible Produktprogramm an Reihenklemmen bietet in diversen Industrieanwendungen und in der modernen Gebäudeinstallation mehr als nur eine sichere elektrische Verbindung.

[Mehr über die Produktfamilie erfahren](#)

[Alle Produkte der Familie anzeigen](#)

Änderungen vorbehalten.

WAGO Kontakttechnik GmbH & Co. KG
Hansastr. 27
32423 Minden
Telefon: +49571 887-0
E-Mail: info.de@wago.com | Web: www.wago.com

Haben Sie Fragen zu unseren Produkten?
Wir stehen Ihnen telefonisch unter +49 (571) 887-44222 gern zur Verfügung.