

Datenblatt | Artikelnummer: 2004-1205

2-Leiter-Durchgangsklemme; 4 mm²; für Anwendungen Ex e II geeignet;
seitliche und mittige Beschriftung; für Tragschiene 35 x 15 und 35 x 7,5;
Push-in CAGE CLAMP®

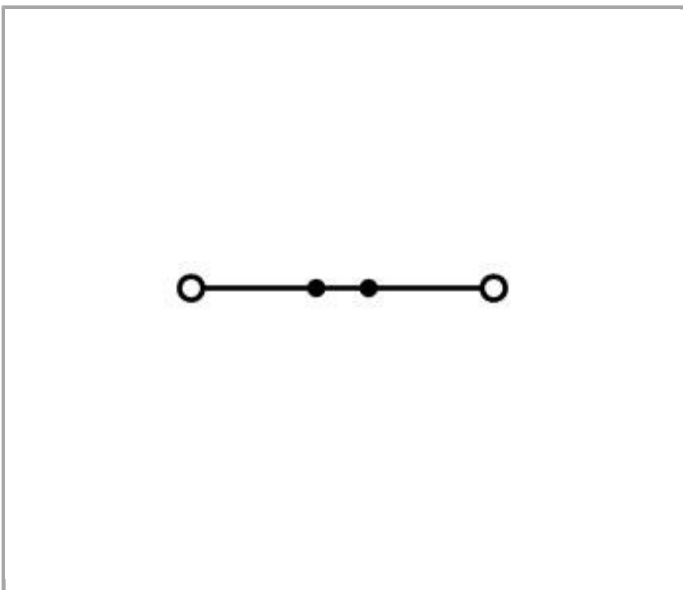

www.wago.com/2004-1205

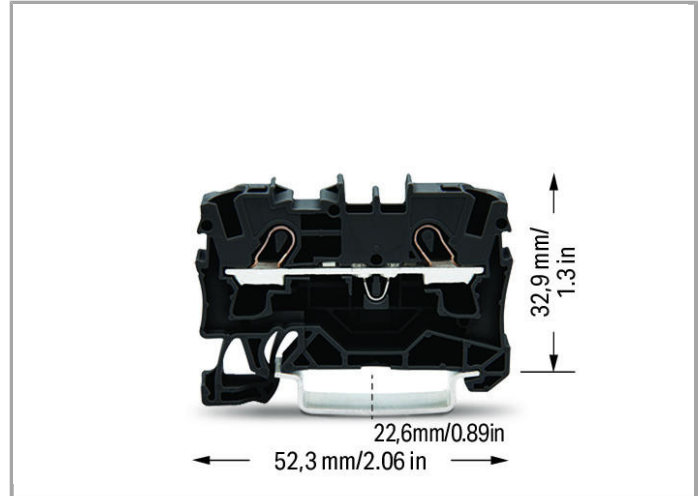

Daten

Elektrische Daten

Bemessungsspannung EN (Ex e II)	550 V
Bemessungsstrom (Ex e II)	30 A

Bemessungsdaten gemäß IEC/EN 60664-1

Bemessungsspannung (III / 3)	800 V
Bemessungsstoßspannung (III / 3)	8 kV
Bemessungsstrom	32 A
Bemessungsstrom 2	41 A
Legende Bemessungsdaten	(III / 3) \triangleq Überspannungskategorie III / Verschmutzungsgrad 3

Bemessungsdaten gemäß UL 1059

Bemessungsspannung UL (Use Group B)	600 V
Bemessungsstrom UL (Use Group B)	30 A
Bemessungsspannung UL (Use Group C)	600 V
Bemessungsstrom UL (Use Group C)	30 A

Bemessungsdaten gemäß CSA

Bemessungsspannung CSA (Use Group B)	600 V
Bemessungsstrom CSA (Use Group B)	30 A
Bemessungsspannung CSA (Use Group C)	600 V
Bemessungsstrom CSA (Use Group C)	30 A

Anschlussdaten

Anschluss technik	Push-in CAGE CLAMP®
Betätigungsart	Push-in Betätigungswerkzeug
Anschließbare Leiterwerkstoffe	Kupfer
Nennquerschnitt	4 mm ²
Eindrätiger Leiter	0,5 ... 6 mm ² / 20 ... 10 AWG
Eindrätiger Leiter, direkt steckbar	1,5 ... 6 mm ² / 14 ... 10 AWG
Feindrätiger Leiter	0,5 ... 6 mm ² / 20 ... 10 AWG
Feindrätiger Leiter; mit Aderendhülse, direkt steckbar ab	1,5 mm ² / 18 AWG
Abisolierlänge	11 ... 13 mm / 0.43 ... 0.51 inch
Gesamte Anzahl der Klemmstellen	2
Gesamte Anzahl der Potentiale	1
Anzahl der Ebenen	1
Verdrahtungsart	Frontverdrahtung

Geometrische Daten

Breite	6,2 mm / 0.244 inch
Höhe ab Oberkante Tragschiene	32,9 mm / 1.295 inch
Tiefe	52,3 mm / 2.059 inch

Mechanische Daten

Bauform	horizontale Bauform
Montageart	Tragschiene 35
Beschriftungsebene	Mitten-/Seitliche Beschriftung

Werkstoffdaten

Farbe	schwarz
Isolierwerkstoff	Polyamid 66 (PA 66)
Brandlast	0.114 MJ
Gewicht	6.325 g

Kaufmännische Daten

Ursprungsland	DE
GTIN	4045454537449
Zolltarifnummer	85369010000
Produktgruppe	22 (TOPJOB S Reihenklemmen)
eCl@ss 9.0	27-14-11-20
eCl@ss 8.0	27-14-11-20
ETIM 6.0	EC000897
ETIM 5.0	EC000897

Zulassungen / Zertifikate

Ex-Zulassungen

Logo	Zulassung	Zertifikatsname
	AEx Underwriters Laboratories Inc.	E185892
	ATEX Physikalisch Technische Bundesanstalt (PTB)	PTB 05 ATEX 1095 U (II 2 G/D Ex eII bzw. I M2 Ex eI)

Länderspezifische Zulassungen



Logo	Zulassung	Zertifikatsname
	CCA DEKRA Certification B.V.	2160584.10
	CCA DEKRA Certification B.V.	NTR NL-7088



CSA
DEKRA Certification B.V.

1645435

Schiff Zulassungen



Logo	Zulassung	Zertifikatsname
	ABS American Bureau of Shipping	14-HG1293677-PDA
	BV Bureau Veritas S.A.	38586/A0 BV
	LR Lloyds Register	91/20112 (E9)

UL-Zulassungen





Logo	Zulassung	Zertifikatsname
	UL UL International Germany GmbH	E45172















Passende Produkte

















Isolierungs-Stopp

	Art-Nr.: 2004-171 Isolierungsstopp; 0,25 - 0,5 mm²; 5 Stück / Strang	www.wago.com/2004-171
	Art-Nr.: 2004-172 Isolierungsstopp; 0,75 - 1 mm²; 5 Stück / Strang	www.wago.com/2004-172

Beschriftungsmaterial

	Art-Nr.: 2009-110 Beschriftungsstreifen; auf Rolle; nicht dehnbar; unbedruckt; aufrastbar	www.wago.com/2009-110
	Art-Nr.: 2009-115 WMB-Inline; für smartPRINTER; auf Rolle; dehnbar 5 - 5,2 mm; unbedruckt; aufrastbar	www.wago.com/2009-115
	Art-Nr.: 2009-115/000-002 WMB-Inline; für smartPRINTER; auf Rolle; dehnbar 5 - 5,2 mm; unbedruckt; aufrastbar	www.wago.com/2009-115/000-002
	Art-Nr.: 2009-115/000-006 WMB-Inline; für smartPRINTER; auf Rolle; dehnbar 5 - 5,2 mm; unbedruckt; aufrastbar	www.wago.com/2009-115/000-006

	Art-Nr.: 2009-115/000-007 WMB-Inline; für smartPRINTER; auf Rolle; dehnbar 5 - 5,2 mm; unbedruckt; aufrastbar	www.wago.com/2009-115/000-007
	Art-Nr.: 2009-115/000-012 WMB-Inline; für smartPRINTER; auf Rolle; dehnbar 5 - 5,2 mm; unbedruckt; aufrastbar	www.wago.com/2009-115/000-012
	Art-Nr.: 2009-115/000-017 WMB-Inline; für smartPRINTER; auf Rolle; dehnbar 5 - 5,2 mm; unbedruckt; aufrastbar	www.wago.com/2009-115/000-017
	Art-Nr.: 2009-115/000-023 WMB-Inline; für smartPRINTER; auf Rolle; dehnbar 5 - 5,2 mm; unbedruckt; aufrastbar	www.wago.com/2009-115/000-023
	Art-Nr.: 2009-115/000-024 WMB-Inline; für smartPRINTER; auf Rolle; dehnbar 5 - 5,2 mm; unbedruckt; aufrastbar	www.wago.com/2009-115/000-024
	Art-Nr.: 2009-135 WMB-Inline; für smartPRINTER; auf Rolle; dehnbar 5 - 5,2 mm; unbedruckt; aufrastbar	www.wago.com/2009-135
	Art-Nr.: 2009-145 Mini-WSB Inline; für smartPRINTER; auf Rolle; dehnbar 5 - 5,2 mm; unbedruckt; aufrastbar	www.wago.com/2009-145
	Art-Nr.: 2009-145/000-002 Mini-WSB Inline; für smartPRINTER; auf Rolle; dehnbar 5 - 5,2 mm; unbedruckt; aufrastbar	www.wago.com/2009-145/000-002
	Art-Nr.: 2009-145/000-005 Mini-WSB Inline; für smartPRINTER; auf Rolle; dehnbar 5 - 5,2 mm; unbedruckt; aufrastbar	www.wago.com/2009-145/000-005
	Art-Nr.: 2009-145/000-006 Mini-WSB Inline; für smartPRINTER; auf Rolle; dehnbar 5 - 5,2 mm; unbedruckt; aufrastbar	www.wago.com/2009-145/000-006
	Art-Nr.: 2009-145/000-007 Mini-WSB Inline; für smartPRINTER; auf Rolle; dehnbar 5 - 5,2 mm; unbedruckt; aufrastbar	www.wago.com/2009-145/000-007
	Art-Nr.: 2009-145/000-012 Mini-WSB Inline; für smartPRINTER; auf Rolle; dehnbar 5 - 5,2 mm; unbedruckt; aufrastbar	www.wago.com/2009-145/000-012
	Art-Nr.: 2009-145/000-023 Mini-WSB Inline; für smartPRINTER; auf Rolle; dehnbar 5 - 5,2 mm; unbedruckt; aufrastbar	www.wago.com/2009-145/000-023
	Art-Nr.: 2009-145/000-024 Mini-WSB Inline; auf Rolle; dehnbar 5 - 5,2 mm; unbedruckt; aufrastbar	www.wago.com/2009-145/000-024
	Art-Nr.: 2009-191 Gruppenschildträger	www.wago.com/2009-191

	Art-Nr.: 2009-192 Gruppenschildträger	www.wago.com/2009-192
	Art-Nr.: 2009-193 Gruppenschildträger	www.wago.com/2009-193
	Art-Nr.: 2009-198 Adapter	www.wago.com/2009-198
	Art-Nr.: 248-501 Mini-WSB-Schnellbeschriftungssystem; unbedruckt; Schildchenbreite 5 mm; 10 Streifen à 10 Schilder pro Karte	www.wago.com/248-501
	Art-Nr.: 248-501/000-002 Mini-WSB-Beschriftungskarte; als Karte; nicht dehnbar; unbedruckt; aufrastbar	www.wago.com/248-501/000-002
	Art-Nr.: 248-501/000-005 Mini-WSB-Beschriftungskarte; als Karte; unbedruckt; aufrastbar	www.wago.com/248-501/000-005
	Art-Nr.: 248-501/000-006 Mini-WSB-Beschriftungskarte; als Karte; nicht dehnbar; unbedruckt; aufrastbar	www.wago.com/248-501/000-006
	Art-Nr.: 248-501/000-007 Mini-WSB-Beschriftungskarte; als Karte; nicht dehnbar; unbedruckt; aufrastbar	www.wago.com/248-501/000-007
	Art-Nr.: 248-501/000-012 Mini-WSB-Beschriftungskarte; als Karte; nicht dehnbar; unbedruckt; aufrastbar	www.wago.com/248-501/000-012
	Art-Nr.: 248-501/000-017 Mini-WSB-Beschriftungskarte; als Karte; nicht dehnbar; unbedruckt; aufrastbar	www.wago.com/248-501/000-017
	Art-Nr.: 248-501/000-023 Mini-WSB-Beschriftungskarte; als Karte; nicht dehnbar; unbedruckt; aufrastbar	www.wago.com/248-501/000-023
	Art-Nr.: 248-501/000-024 Mini-WSB-Beschriftungskarte; als Karte; nicht dehnbar; unbedruckt; aufrastbar	www.wago.com/248-501/000-024
	Art-Nr.: 793-501 WMB-Beschriftungskarte; als Karte; nicht dehnbar; unbedruckt; aufrastbar	www.wago.com/793-501
	Art-Nr.: 793-501/000-002 WMB-Beschriftungskarte; als Karte; nicht dehnbar; unbedruckt; aufrastbar	www.wago.com/793-501/000-002
	Art-Nr.: 793-501/000-005 WMB-Beschriftungskarte; als Karte; nicht dehnbar; unbedruckt; aufrastbar	www.wago.com/793-501/000-005
	Art-Nr.: 793-501/000-006 WMB-Beschriftungskarte; als Karte; nicht dehnbar; unbedruckt; aufrastbar	www.wago.com/793-501/000-006



Art-Nr.: 793-501/000-007
WMB-Beschriftungskarte; als Karte; nicht dehnbar; unbedruckt; aufrastbar

www.wago.com/793-501/000-007



Art-Nr.: 793-501/000-012
WMB-Beschriftungskarte; als Karte; nicht dehnbar; unbedruckt; aufrastbar

www.wago.com/793-501/000-012



Art-Nr.: 793-501/000-017
WMB-Beschriftungskarte; als Karte; nicht dehnbar; unbedruckt; aufrastbar

www.wago.com/793-501/000-017



Art-Nr.: 793-501/000-023
WMB-Beschriftungskarte; als Karte; nicht dehnbar; unbedruckt; aufrastbar

www.wago.com/793-501/000-023



Art-Nr.: 793-501/000-024
WMB-Beschriftungskarte; als Karte; nicht dehnbar; unbedruckt; aufrastbar

www.wago.com/793-501/000-024



Art-Nr.: 793-5501
WMB-Beschriftungskarte; als Karte; für Klemmenbreite 5 - 17,5 mm; dehnbar 5 - 5,2 mm; unbedruckt; aufrastbar

www.wago.com/793-5501



Art-Nr.: 793-5501/000-002
WMB-Beschriftungskarte; als Karte; für Klemmenbreite 5 - 17,5 mm; dehnbar 5 - 5,2 mm; unbedruckt; aufrastbar

www.wago.com/793-5501/000-002



Art-Nr.: 793-5501/000-005
WMB-Beschriftungskarte; als Karte; dehnbar 5 - 5,2 mm; unbedruckt; aufrastbar

www.wago.com/793-5501/000-005



Art-Nr.: 793-5501/000-006
WMB-Beschriftungskarte; als Karte; dehnbar 5 - 5,2 mm; unbedruckt; aufrastbar

www.wago.com/793-5501/000-006



Art-Nr.: 793-5501/000-007
WMB-Beschriftungskarte; als Karte; dehnbar 5 - 5,2 mm; unbedruckt; aufrastbar

www.wago.com/793-5501/000-007



Art-Nr.: 793-5501/000-012
WMB-Beschriftungskarte; als Karte; dehnbar 5 - 5,2 mm; unbedruckt; aufrastbar

www.wago.com/793-5501/000-012



Art-Nr.: 793-5501/000-017
WMB-Beschriftungskarte; als Karte; dehnbar 5 - 5,2 mm; unbedruckt; aufrastbar

www.wago.com/793-5501/000-017



Art-Nr.: 793-5501/000-023
WMB-Beschriftungskarte; als Karte; dehnbar 5 - 5,2 mm; unbedruckt; aufrastbar

www.wago.com/793-5501/000-023







Art-Nr.: 793-5501/000-024
WMB-Beschriftungskarte; als Karte; dehnbar 5 - 5,2 mm; unbedruckt; aufrastbar









www.wago.com/793-5501/000-024

Aderendhülse

Art-Nr.: 216-262

	Aderendhülse; Hülse für 0,75 mm ² / AWG 20; mit Kunststoffkragen; galvanisch verzinkt; Elektrolytkupfer; gasdicht aufgecrimpt; gemäß DIN 46228, Teil 4/09.90	www.wago.com/216-262
	Art-Nr.: 216-263 Aderendhülse; Hülse für 1 mm ² / AWG 18; mit Kunststoffkragen; galvanisch verzinkt; Elektrolytkupfer; gasdicht aufgecrimpt; gemäß DIN 46228, Teil 4/09.90	www.wago.com/216-263
	Art-Nr.: 216-264 Aderendhülse; Hülse für 1,5 mm ² / AWG 16; mit Kunststoffkragen; galvanisch verzinkt; Elektrolytkupfer; gasdicht aufgecrimpt; gemäß DIN 46228, Teil 4/09.90	www.wago.com/216-264
	Art-Nr.: 216-266 Aderendhülse; Hülse für 2,5 mm ² / AWG 14; mit Kunststoffkragen; galvanisch verzinkt; Elektrolytkupfer; gasdicht aufgecrimpt; gemäß DIN 46228, Teil 4/09.90	www.wago.com/216-266
	Art-Nr.: 216-267 Aderendhülse; Hülse für 4 mm ² / AWG 12; mit Kunststoffkragen; galvanisch verzinkt; Elektrolytkupfer; gasdicht aufgecrimpt; gemäß DIN 46228, Teil 4/09.90	www.wago.com/216-267

Prüfen und Messen

	Art-Nr.: 2004-511 Modularer TOPJOB®S-Steckverbinder; anreihbar; für Brückerschlitze; 1-polig	www.wago.com/2004-511
	Art-Nr.: 2004-549 Blindmodul; anreihbar; zum Überspringen von z. B. gebrückten Klemmen	www.wago.com/2004-549
	Art-Nr.: 2004-552 TOPJOB®S-Steckverbinderleiste; für Brückerschlitze; 2-polig	www.wago.com/2004-552
	Art-Nr.: 2004-553 TOPJOB®S-Steckverbinderleiste; für Brückerschlitze; 3-polig	www.wago.com/2004-553
	Art-Nr.: 2004-554 TOPJOB®S-Steckverbinderleiste; für Brückerschlitze; 4-polig	www.wago.com/2004-554
	Art-Nr.: 2004-555 TOPJOB®S-Steckverbinderleiste; für Brückerschlitze; 5-polig	www.wago.com/2004-555
	Art-Nr.: 2009-174 Prüfadapter; für Prüfstecker Ø 4 mm; zur Prüfung von TOPJOB®S-Reihenklemmen	www.wago.com/2009-174
	Art-Nr.: 2009-182 Prüfabgriff; für max. 2,5 mm ² ; für den werkzeuglosen Anschluss individueller Prüfleitungen von 0,08 mm - 2,5 mm	www.wago.com/2009-182

Abschlussplatte

	Art-Nr.: 2004-1291 Abschluss- und Zwischenplatte; 1 mm dick	www.wago.com/2004-1291
	Art-Nr.: 2004-1292 Abschluss- und Zwischenplatte; 1 mm dick	www.wago.com/2004-1292
	Art-Nr.: 2004-1293 Trennwand; 2 mm dick; überstehend	www.wago.com/2004-1293
	Art-Nr.: 2004-1294 Trennwand; 2 mm dick; überstehend	www.wago.com/2004-1294
	Art-Nr.: 209-190 Trennwand Ex e/Ex i; 3 mm dick; 90 mm breit	www.wago.com/209-190



Art-Nr.: 209-191
Trennwand Ex e/Ex i; 3 mm dick; 120 mm breit

www.wago.com/209-191

Brücker



Art-Nr.: 2004-402
Kammbrücker; isoliert; 2-fach; Nennstrom 32 A

www.wago.com/2004-402



Art-Nr.: 2004-403
Kammbrücker; isoliert; 3-fach; Nennstrom 32 A

www.wago.com/2004-403



Art-Nr.: 2004-404
Kammbrücker; isoliert; 4-fach; Nennstrom 32 A

www.wago.com/2004-404



Art-Nr.: 2004-405
Kammbrücker; isoliert; 5-fach; Nennstrom 32 A

www.wago.com/2004-405



Art-Nr.: 2004-405/011-000
Sternbrücker; isoliert; 3-fach (1-3-5); IN = IN Klemme

www.wago.com/2004-405/011-000



Art-Nr.: 2004-406
Kammbrücker; isoliert; 6-fach; Nennstrom 32 A

www.wago.com/2004-406



Art-Nr.: 2004-406/020-000
Dreieckbrücker; isoliert; 1-2 3-4 5-6; IN = IN Klemme

www.wago.com/2004-406/020-000



Art-Nr.: 2004-407
Kammbrücker; isoliert; 7-fach; Nennstrom 32 A

www.wago.com/2004-407



Art-Nr.: 2004-408
Kammbrücker; isoliert; 8-fach; Nennstrom 32 A

www.wago.com/2004-408



Art-Nr.: 2004-409
Kammbrücker; isoliert; 9-fach; Nennstrom 32 A

www.wago.com/2004-409



Art-Nr.: 2004-410
Kammbrücker; isoliert; 10-fach; Nennstrom 32 A

www.wago.com/2004-410



Art-Nr.: 2004-433
Kammbrücker; isoliert; von 1 auf 3; Nennstrom 32 A

www.wago.com/2004-433



Art-Nr.: 2004-434
Kammbrücker; isoliert; von 1 auf 4; Nennstrom 32 A

www.wago.com/2004-434



Art-Nr.: 2004-435
Kammbrücker; isoliert; von 1 auf 5; Nennstrom 32 A

www.wago.com/2004-435



Art-Nr.: 2004-436
Kammbrücker; isoliert; von 1 auf 6; Nennstrom 32 A

www.wago.com/2004-436



Art-Nr.: 2004-437
Kammbrücker; isoliert; von 1 auf 7; Nennstrom 32 A

www.wago.com/2004-437

Art-Nr.: 2004-438

	Kammbrücke; isoliert; von 1 auf 8; Nennstrom 32 A	www.wago.com/2004-438
----------------------------------------------------------------------------------	---------------------------------------------------	------------------------------------------------------------------

	Art-Nr.: 2004-439 Kammbrücke; isoliert; von 1 auf 9; Nennstrom 32 A	www.wago.com/2004-439
----------------------------------------------------------------------------------	-------------------------------------------------------------------------------	------------------------------------------------------------------

	Art-Nr.: 2004-440 Kammbrücke; isoliert; von 1 auf 10; Nennstrom 32 A	www.wago.com/2004-440
----------------------------------------------------------------------------------	--------------------------------------------------------------------------------	------------------------------------------------------------------

	Art-Nr.: 2006-499 Reduzierbrücke; isoliert; von 6/4 mm ² auf 4/2,5/1,5 mm ² ; Nennstrom 32 A	www.wago.com/2006-499
----------------------------------------------------------------------------------	------------------------------------------------------------------------------------------------------------------------------	------------------------------------------------------------------

	Art-Nr.: 2016-499 Reduzierbrücke; isoliert; von 16/10 mm ² auf 10/6/4/2,5 mm ² ; Nennstrom 57 A	www.wago.com/2016-499
----------------------------------------------------------------------------------	---------------------------------------------------------------------------------------------------------------------------------	------------------------------------------------------------------

	Art-Nr.: 210-103 Drahtkettenbrücke; isoliert; 50 Anschlüsse	www.wago.com/210-103
----------------------------------------------------------------------------------	-----------------------------------------------------------------------	----------------------------------------------------------------

	Art-Nr.: 210-123 Drahtkettenbrücke; isoliert; 50 Anschlüsse	www.wago.com/210-123
----------------------------------------------------------------------------------	-----------------------------------------------------------------------	----------------------------------------------------------------

Werkzeug

	Art-Nr.: 210-658 Betätigungswerkzeug mit teilisoliertem Schaft; Klinge (3,5 x 0,5) mm; kurz; abgewinkelt	www.wago.com/210-658
----------------------------------------------------------------------------------	--------------------------------------------------------------------------------------------------------------------	----------------------------------------------------------------

	Art-Nr.: 210-720 Betätigungswerkzeug mit teilisoliertem Schaft; Typ 2, Klinge (3,5 x 0,5) mm	www.wago.com/210-720
-----------------------------------------------------------------------------------	--------------------------------------------------------------------------------------------------------	----------------------------------------------------------------

Warnabdeckung

	Art-Nr.: 2004-115 Warnabdeckung; mit schwarzem Blitzpfeil; für 5 Klemmen	www.wago.com/2004-115
------------------------------------------------------------------------------------	------------------------------------------------------------------------------------	------------------------------------------------------------------

Tragschiene

	Art-Nr.: 210-112 Stahltragschiene; 35 x 7,5 mm; 1 mm dick; 2 m lang; gelocht; entsprechend EN 60715; Lochbreite 25 mm; Lochabstand 36 mm	www.wago.com/210-112
------------------------------------------------------------------------------------	----------------------------------------------------------------------------------------------------------------------------------------------------	----------------------------------------------------------------

	Art-Nr.: 210-113 Stahltragschiene; 35 x 7,5 mm; 1 mm dick; 2 m lang; ungelocht; entsprechend EN 60715	www.wago.com/210-113
------------------------------------------------------------------------------------	-----------------------------------------------------------------------------------------------------------------	----------------------------------------------------------------

	Art-Nr.: 210-114 Stahltragschiene; 35 x 15 mm; 1,5 mm dick; 2 m lang; ungelocht; ähnlich EN 60715	www.wago.com/210-114
------------------------------------------------------------------------------------	-------------------------------------------------------------------------------------------------------------	----------------------------------------------------------------

	Art-Nr.: 210-115 Stahltragschiene; 35 x 7,5 mm; 1 mm dick; 2 m lang; gelocht; entsprechend EN 60715; Lochbreite 18 mm; Lochabstand 25 mm	www.wago.com/210-115
------------------------------------------------------------------------------------	----------------------------------------------------------------------------------------------------------------------------------------------------	----------------------------------------------------------------

	Art-Nr.: 210-118 Stahltragschiene; 35 x 15 mm; 2,3 mm dick; 2 m lang; ungelocht; entsprechend EN 60715	www.wago.com/210-118
------------------------------------------------------------------------------------	------------------------------------------------------------------------------------------------------------------	----------------------------------------------------------------

	Art-Nr.: 210-196 Aluminiumtragschiene; 35 x 8,2 mm; 1,6 mm dick; 2 m lang; ungelocht; ähnlich EN 60715	www.wago.com/210-196
------------------------------------------------------------------------------------	------------------------------------------------------------------------------------------------------------------	----------------------------------------------------------------

	Art-Nr.: 210-197 Stahltragschiene; 35 x 15 mm; 1,5 mm dick; 2 m lang; gelocht; ähnlich EN 60715	www.wago.com/210-197
------------------------------------------------------------------------------------	-----------------------------------------------------------------------------------------------------------	----------------------------------------------------------------



Art-Nr.: 210-198

Kupfertragschiene; 35 x 15 mm; 2,3 mm dick; 2 m lang; ungelocht; entsprechend EN 60715

www.wago.com/210-198

Downloads

Dokumentation

Ausschreibungstext

2004-1205	Aug 13, 2018	DOCX	Download
Reihenklemmen, TOPJOB S		15,0 kB	

smartDATA

CAD Daten

3D Download 2004-1205	URL	Download
-----------------------	-----	----------

Produktfamilie

TOPJOB S

TOPJOB® S: Das breite und flexible Produktprogramm an Reihenklemmen bietet in diversen Industrieanwendungen und in der modernen Gebäudeinstallation mehr als nur eine sichere elektrische Verbindung.

[Mehr über die Produktfamilie erfahren](#)

[Alle Produkte der Familie anzeigen](#)

Änderungen vorbehalten.

WAGO Kontakttechnik GmbH & Co. KG
Hansastr. 27
32423 Minden
Telefon: +49571 887-0
E-Mail: info.de@wago.com | Web: www.wago.com

Haben Sie Fragen zu unseren Produkten?
Wir stehen Ihnen telefonisch unter +49 (571) 887-44222 gern zur Verfügung.