

Z	Y	X
0.7+1.25	13 ±0.1	19 +0.2
1.25+2	13 ±0.1	19.3+0.2
2+3	13 ±0.1	19.6+0.2

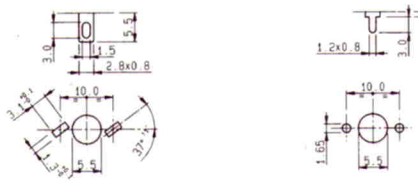
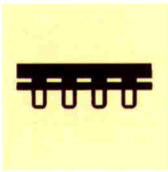

0

5

8

4

?



0

0

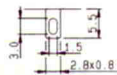
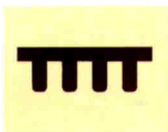

0

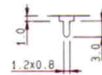

2

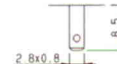

4

0

5

8

4



0

0



0-2-4



4



0-2

2(1)A/250V~
1(0.5)A/250V -5E4
T120 °C

2A/125-250VAC

T65 °C

2

6(4)A/250V~
5(2)A/250V -5E4
T120 °C

6A/125-250VAC
1/6HP-250VAC
1/8HP-125VAC
T65 °C

4

10(4)A/250V~
5(2)A/250V -5E4
T120 °C

6A/125-250VAC
1/6HP-250VAC
1/8HP-125VAC
T65 °C

6

0 5 8 4 [] [] ? [] [] [] [] 0 0

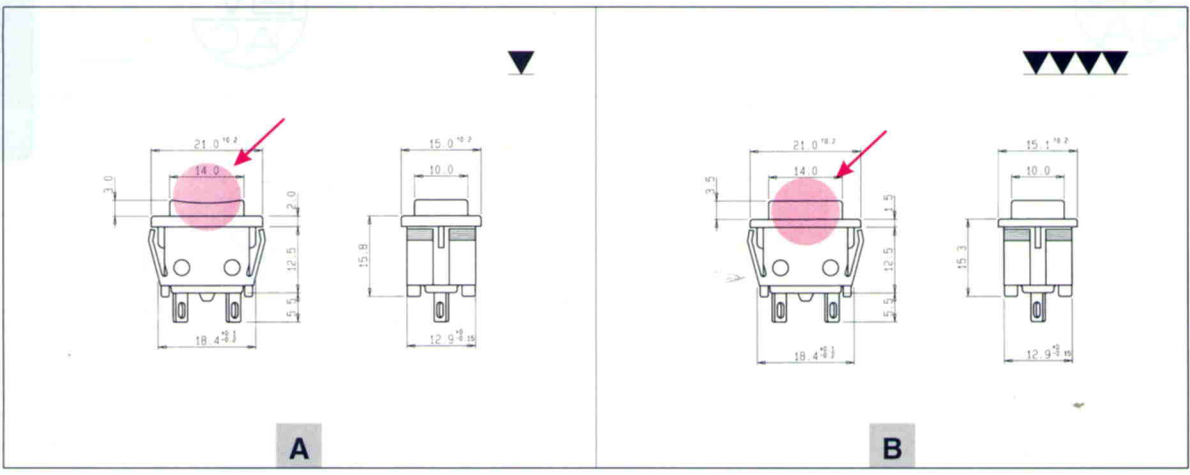

0 5 8 4 [] [] [] ? [] [] [] 0 0

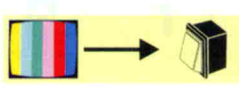

51	52	57	61	75	71	65	90	54	77			
1	2	3	4	5	6	8	9	A	Z			

0 5 8 4 [] [] [] [] ? [] [] 0 0

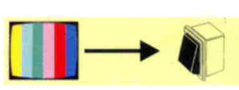

51	52	57	61	75	71	65	90	54	652	77		
1	2	3	4	5	6	8	9	A	B	Z		

0 5 8 4 [] [] [] [] [] ? [] 0 0

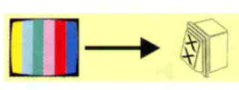

01	02	03	04	05	06	07	08	09	10	14		
1	2	3	4	5	6	7	8	9	A	B	0	X

0 5 8 4 [] [] [] [] [] [] ? 0 0

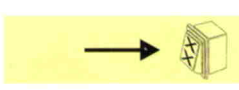

h												
1											0	X