



Frontabmessung: Ø 28 mm
Einbauöffnung: Ø 22 mm
Frontrahmenhöhe: 2 mm
Hub: 3 mm



RONTRON-R-JUWEL

Übersicht / Hülsenfarben / Symbolerklärung Baureihe RONTRON-R-JUWEL



01 Drucktasten	Seite 139	USB-Buchsen	Seite 146
02 Not-Aus-Tasten / Not-Halt-Tasten	Seite 140	RJ45-Buchsen	Seite 146
03 Wahltasten	Seite 140		
04 Schlüsseltasten	Seite 143		
05 Akustische Signalgeber	Seite 145		
06 Leuchtensvorsatz / Meldeleuchten	Seite 147		



IP65 Schutzart

 beleuchtbar

3mm Betätigungshub

 beschriftbar

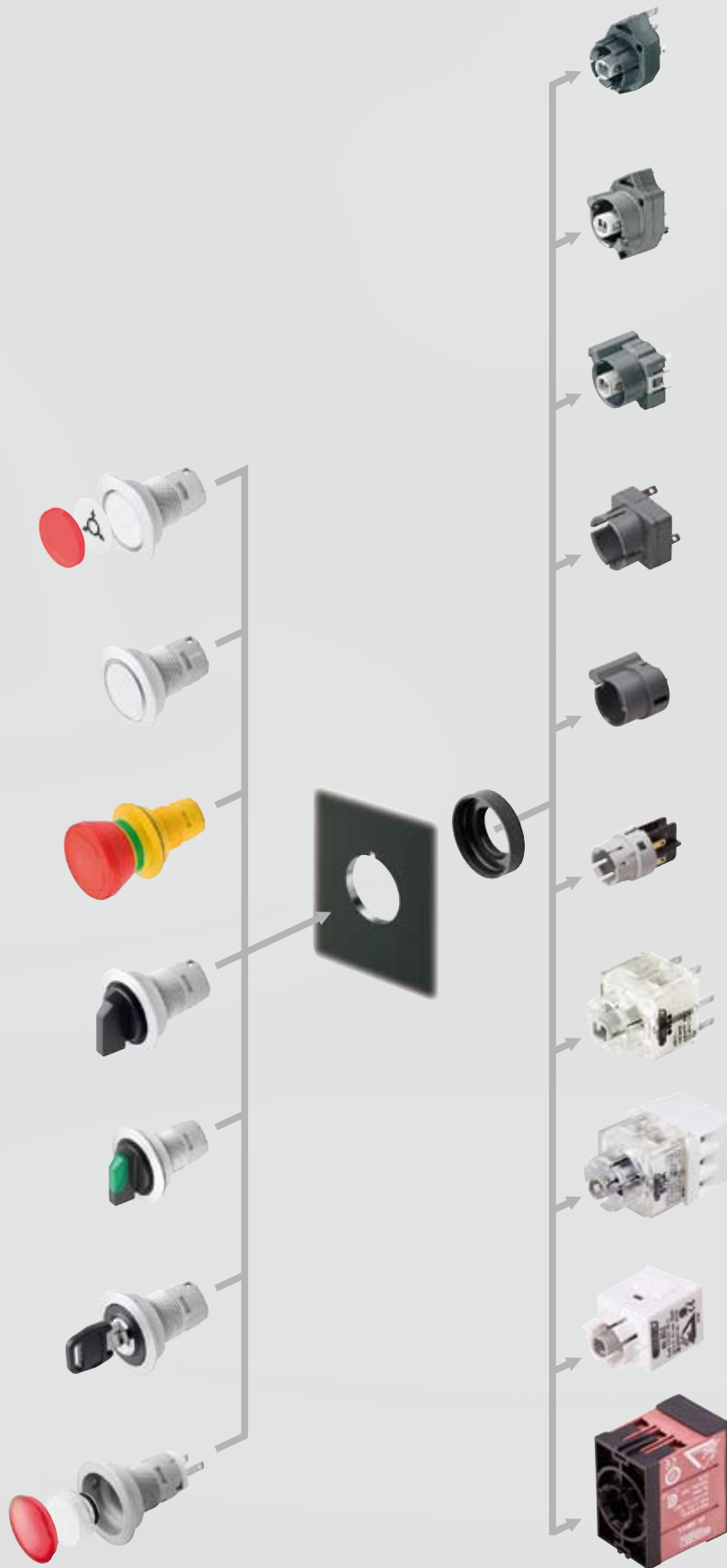

Einbautiefenmaße

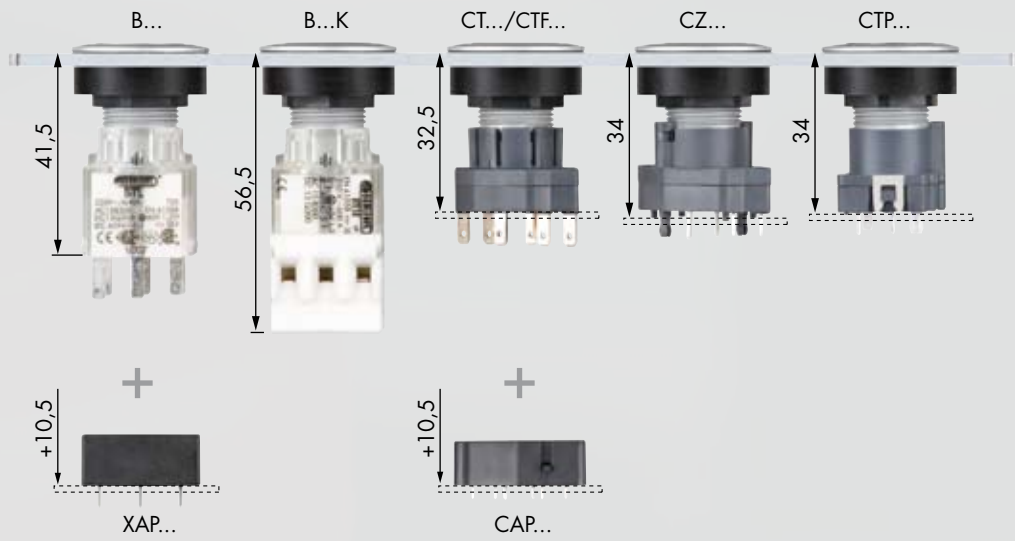

Maße Einbauöffnung

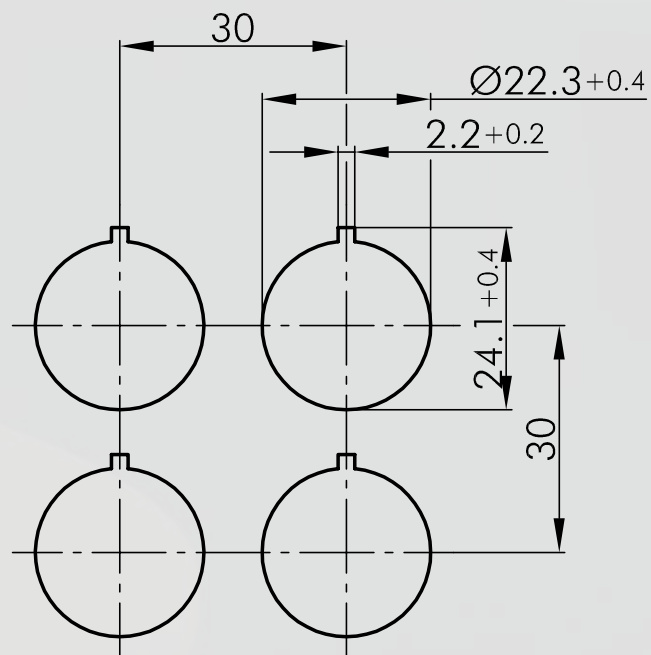

Montage- und Serviceanweisung

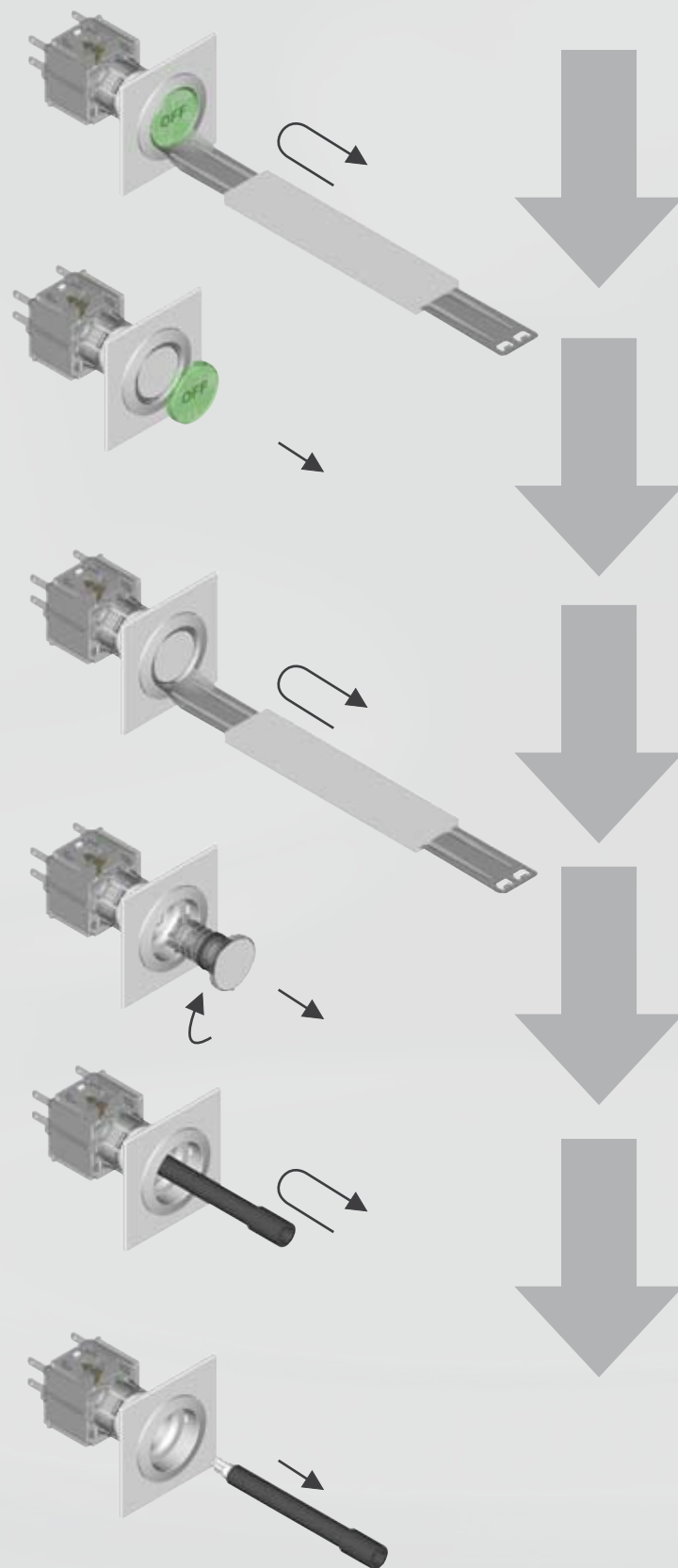

	RRJL4	RRJN	RRJSSA12	RRJSSA13	RRJSSA14	RRJSSA15	RRJSSA16	RRJSSA17	RRJSSA18	RRJSSA23	RRJSSA25	RRJSSA28	RRJSSA31	RRJSTA	RRJSTAL...	RRJSTB	RRJSTBL...	RRJSTB_514	RRJT	RRJTLR	RRJUV	RRJWA	RRJWAL...	RRJWA_514	RRJWB	RRJWBL...	RRJWB_514	RRJWC	RRJWCL...
ASI_BZ																													
ASI_BZL5		●																											
ASI_SAW16A/...E																						●							
AZ2N																							●						
BF(K)																				●									
BFI(K)																				●									
BFL(K)																				●									
BFL5(K)																				●									
BFL5_439																				●									
BFLI(K) / BFLI5(K)																				●									
BFL_439																				●									
BF_439																				●									
BL4(K) / BL5(K)		●																											
BT(K)					●	●	●	●	●			●		●						●			●		●				
BTI(K)					●	●	●	●	●			●		●						●			●		●				
BTL(K) / BTL5(K)		●														●				●			●		●				
BTL5_439																●				●			●		●				
BTLI(K) / BTLI5(K)																●				●			●		●				
BTLO(K) / BTLO5(K)																●				●			●		●				
BTL_439																●				●			●		●				
BTO(K)						●	●	●	●	●		●		●						●			●		●				
BT_439						●	●	●	●	●		●		●						●			●		●				
BZI(K)						●	●	●	●	●		●		●						●			●		●				
BZII(K)			●	●	●	●	●	●	●	●	●	●	●	●	●	●		●		●			●		●		●	●	
BZLI(K) / BZLI5(K)																●				●			●		●				
BZLII(K) / BZLII5(K)																●				●			●		●				●
BZLO(K) / BZLO5(K)																●				●			●		●				
BZLOI(K) / BZLOI5(K)																●				●			●		●				●
BZLOO(K) / BZLOO5(K)																●				●			●		●				●
BZL_439																●				●			●		●				●
BZO(K)						●	●	●	●	●		●		●						●			●		●				
BZOI(K)			●	●	●	●	●	●	●	●	●	●	●	●	●	●		●		●			●		●		●	●	
BZOO(K)			●	●	●	●	●	●	●	●	●	●	●	●	●	●		●		●			●		●		●	●	
BZOS(K)																				●									
BZ_439			●	●						●	●		●			●								●				●	
CL		●																											
CLP_485		●																											
CT						●	●	●	●	●		●		●						●			●		●				
CT2			●	●	●	●	●	●	●	●	●	●	●	●	●	●		●		●			●		●		●	●	
CTF						●	●	●	●	●		●		●						●			●		●				
CTL																●				●			●		●				
CTL2																●				●			●		●		●		●
CTLF																●				●			●		●				
CTLP_485																●				●			●		●				
CTP_485							●	●	●	●	●		●		●					●			●		●				
CZLP		●																											
CZTLP																●				●			●		●				
CZTLP2																●		●		●			●		●		●		●
CZTP																●				●			●		●				
CZTP2			●	●	●	●	●	●	●	●	●	●	●	●	●	●		●		●			●		●		●	●	
L4		●																											
PTFOI																						●							
PTFOO																						●							
PTFPOI																						●							
PTFPOO																						●							
PTPOI																						●							
PTPOO																						●							

Drucktaste (tastend/schaltend)

Tasterkappen/Kalotten und Bezeichnungsschilder bitte extra bestellen

Abbildung	Abmessung	Beschreibung	Type
  	<p>Drucktaste Frontrahmen metallisch</p>	RRJT	
	<p>Tasterkappe, flach, transparent Farben: BL-blau, GB-gelb, GN-grün, KL-glasklar, RT-rot, WS-opalweiß Kurzbezeichnung an die Type anhängen, z. B. T22RRBL</p>	T22RR...	
	<p>Tasterkappe, flach, gedeckt Ausführung für unbeschriftete Tasten (nicht beleuchtbar). Farben: BL-blau, GB-gelb, GN-grün, SW-schwarz, RT-rot, WS-weiß Kurzbezeichnung an die Type anhängen, z. B. T22RRGWS</p>	T22RRG...	
	<p>Bezeichnungsschild unbedruckt</p>	BSRRU	
	<p>Bezeichnungsschild mit Standarddruck, bitte Index-Nr. angeben (siehe Bezeichnungsschilder)</p>	BSRR...	
	<p>Bezeichnungsschild mit Sonderdruck nach Kundenangabe</p>	BSRRB	
  	<p>Drucktaste mit Ringbeleuchtung inkl. Tasterkappe, Beschriftung auf Anfrage Frontrahmen metallisch</p>	RRJTLR	

Inhalt
 Warten
 Befehlsgeräte
 Betreuer
 Freilaufverbindungen
 Scherisse
 Entschalter
 Freilaufschalter
 Halbleitungen

Ø 22 mm

Not-Halt/Not-Aus-Taste
Potentiometer-Antrieb
Wahltaste (tastend/schaltend)

I = Schaltstellung
 > = Federrückzug

Abbildung

Abmessung

Beschreibung

Type

IP65

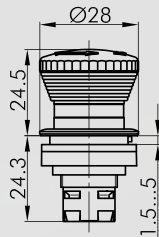

Not-Aus-Taste



überlistsicher Ja
 Schaltstellungsanzeige Ja
 Blockierschutzkragen Nein
 Entriegelung Rechts- und Linksdrehung
 Norm EN 60947-5-1, EN 60947-5-5, EN 60068, EN 13850
 Pilzknopf rot
 Frontrahmen gelb

RRJUV



Weitere Not-Halt/Not-Aus-Tasten finden Sie in der Rubrik „Not-Halt/Not-Aus-Tasten“

Die Not-Halt/Not-Aus-Tasten sind auch mit anderen Pilzknopffarben als verrastbare Pilztasten lieferbar.

IP65

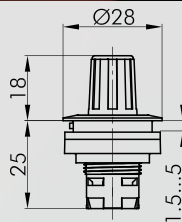

Potentiometer-Antrieb

Mit Drehgriff, jedoch ohne Poti. Für Poti mit 6 mm Achsendurchmesser und Gewinde M10 x 0,75.
 Achsenlänge: ca. 32 mm
 Frontrahmen metallisch

RRJR

IP65

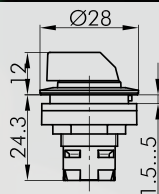

Wahltaste

Frontrahmen metallisch



RRJWA

IP65

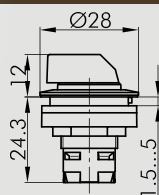

Wahltaste

Frontrahmen metallisch

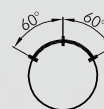

RRJWB

Wahltaste (tastend/schaltend)

I = Schaltstellung
> = Federrückzug

Abbildung

Abmessung

Beschreibung

Type

IP65

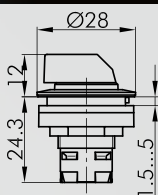

Wahltaste
Frontrahmen

metallisch

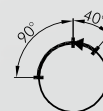

RRJWC

IP65

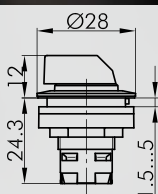

Schwenktaste
Frontrahmen

metallisch



RRJSTA

IP65

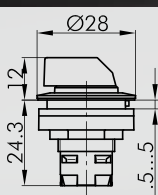

Schwenktaste
Frontrahmen

metallisch



RRJSTB

IP65

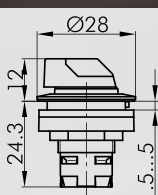

Leucht-Wahltaste

Knebefarben: BL-blau, GB-gelb, KL-glasklar, GN-grün, RT-rot (z.B. RRJWAL_GN)
Frontrahmen

metallisch



RRJWAL...

IP65

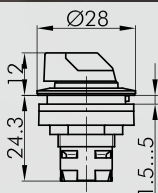

Leucht-Wahltaste

Knebefarben: BL-blau, GB-gelb, KL-glasklar, GN-grün, RT-rot (z.B. RRJWBL_GN)
Frontrahmen

metallisch



RRJWBL...

IP65

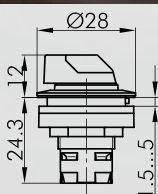

Leucht-Wahltaste

Knebefarben: BL-blau, GB-gelb, KL-glasklar, GN-grün, RT-rot (z.B. RRJWCL_GN)
Frontrahmen

metallisch



RRJWCL...

Ø 22 mm

Wahltaste (tastend/schaltend)

I = Schaltstellung
> = Federrückzug

Abbildung

Abmessung

Beschreibung

Type

IP65

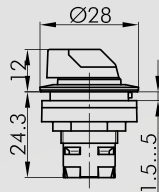

Leucht-Schwenktaste

Knebefarben: BL-blau, GB-gelb, KL-glasklar, GN-grün, RT-rot (z.B. RRJSTAL_GN)
Frontrahmen metallisch



RRJSTAL...

IP65

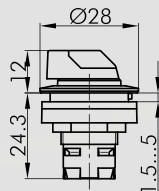

Leucht-Schwenktaste

Knebefarben: BL-blau, GB-gelb, KL-glasklar, GN-grün, RT-rot (z.B. RRJSTBL_GN)
Frontrahmen metallisch



RRJSTBL...

IP65



wüstentaugliche Wahl taste

geprüft mit Arizona-Staub grob
Knebefarbe schwarz
Frontrahmen metallisch



RRJWA_514

IP65



wüstentaugliche Wahl taste

geprüft mit Arizona-Staub grob
Knebefarbe schwarz
Frontrahmen metallisch



RRJWB_514

IP65



wüstentaugliche Wahl taste

geprüft mit Arizona-Staub grob
Knebefarbe schwarz
Frontrahmen metallisch



RRJSTB_514

Schlüsseltaste (tastend/schaltend)

- I = Schaltstellung
- > = Federrückzug
- = Schlüsselabzugstellung

Abbildung

Abmessung

Beschreibung

Type

IP65

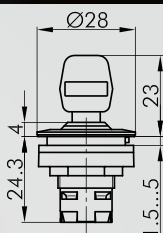

Schlüsseltaste

inkl. zwei Schlüssel
verschiedenschließend möglich, Mehrpreis a. A.
Frontrahmen metallisch

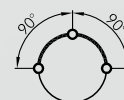

RRJSSA12

IP65

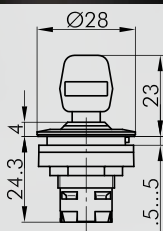

Schlüsseltaste

inkl. zwei Schlüssel
verschiedenschließend möglich, Mehrpreis a. A.
Frontrahmen metallisch



RRJSSA13

IP65

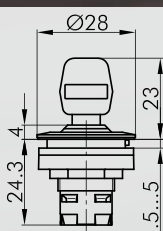

Schlüsseltaste

inkl. zwei Schlüssel
verschiedenschließend möglich, Mehrpreis a. A.
Frontrahmen metallisch



RRJSSA14

IP65

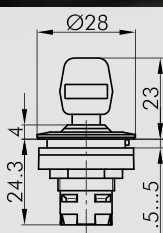

Schlüsseltaste

inkl. zwei Schlüssel
verschiedenschließend möglich, Mehrpreis a. A.
Frontrahmen metallisch



RRJSSA15

IP65

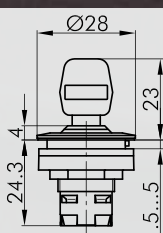

Schlüsseltaste

inkl. zwei Schlüssel
verschiedenschließend möglich, Mehrpreis a. A.
Frontrahmen metallisch



RRJSSA16

Inhalt
 Befehlsgeräte
 Berührer
 Freilaufverbindungen
 Scherrelle
 Entschalter
 Fallschalter
 Halbleiterventile

RONTRON-R-JUWEL

Ø 22 mm

Schlüsseltaste (tastend/schaltend)

- I = Schaltstellung
- > = Federrückzug
- = Schlüsselabzugstellung

Abbildung	Abmessung	Beschreibung	Type
		Schlüsseltaste inkl. zwei Schlüssel verschiedenschließend möglich, Mehrpreis a. A. Frontrahmen metallisch	 RRJSSA17
		Schlüsseltaste inkl. zwei Schlüssel verschiedenschließend möglich, Mehrpreis a. A. Frontrahmen metallisch	 RRJSSA18
		Schlüsseltaste inkl. zwei Schlüssel verschiedenschließend möglich, Mehrpreis a. A. Frontrahmen metallisch	 RRJSSA23
		Schlüsseltaste inkl. zwei Schlüssel verschiedenschließend möglich, Mehrpreis a. A. Frontrahmen metallisch	 RRJSSA25
		Schlüsseltaste inkl. zwei Schlüssel verschiedenschließend möglich, Mehrpreis a. A. Frontrahmen metallisch	 RRJSSA28

**Schlüsseltaste (tastend/schaltend)
Akustischer Signalgeber**

- I = Schaltstellung
- > = Federrückzug
- = Schlüsselabzugstellung

Abbildung

Abmessung

Beschreibung

Type

IP65

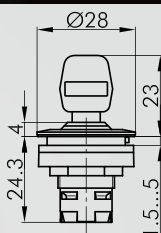

Schlüsseltaste

inkl. drei Schlüssel

- 1. Schlüssel: Rechts-Links-Betätigung
 - 2. Schlüssel: nur Links-Betätigung
 - 3. Schlüssel: nur Rechts-Betätigung
- Frontrahmen metallisch

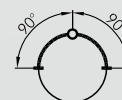

RRJSSA31



Ersatzschlüssel

bitte Schlüsselnr. angeben

ESMIC...

IP65

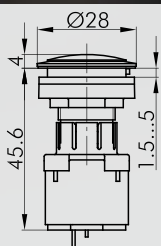

Akustischer Signalgeber

Betriebsspannung: 12 ... 24V AC/DC
 Betriebsstrom: max. 30mA
 Signalfrequenz: 3,5 +/- 0,5 kHz
 Lautstärke: max. 87 db (10cm, 24V)
 max. 85 db (10cm, 12V)
 Betriebstemperatur: -20°C ... 60°C
 Frontrahmen metallisch

RRJNSG+SG-24V

IP65

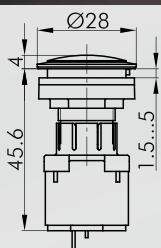

Akustischer Intervall-Signalgeber

Betriebsspannung: 12 ... 24V AC/DC
 Betriebsstrom: max. 30mA
 Signalfrequenz: 3,5 +/- 0,5 kHz
 Lautstärke: max. 87 db (10cm, 24V)
 max. 85 db (10cm, 12V)
 Intervall: 1s
 Betriebstemperatur: -20°C ... 60°C
 Frontrahmen metallisch

RRJNSG+SIG-24V



Flachsteckhülse 2,8 x 0,8 mm mit Rastzunge

FH2,8

Querschnittsbereich 0,75 - 1,50 mm², Messing, mit Rastzunge zum Einrasten in Anschlussstecker XA, XAL und IH2,8



Isolierstoffhülse

IH2,8

für Flachsteckhülse FH2,8, von vorne aufsteckbar

Ø 22 mm

USB-/RJ45-Buchse

Abbildung

Abmessung

Beschreibung

Type



Flachsteckverteiler

FD2,8

zum Anschließen von 2 Flachsteckhülsen FH2,8 an einer Flachsteckzunge 2,8 x 0,8 mm

IP65

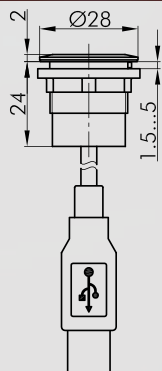

USB-Buchse

vorne:
USB-Buchse: Typ A

hinten:
USB2.0 - Kabel (Länge 60 cm) mit Stecker Typ A
Frontrahmen metallisch

RRJ_USB

IP65

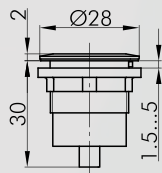

USB-Buchse

vorne:
USB-Buchse: Typ A

hinten:
USB-Buchse: Typ A
Frontrahmen metallisch

RRJ_USB_AA

IP65

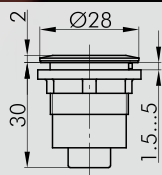

USB-Buchse

vorne:
USB-Buchse: Typ A

hinten:
USB-Buchse: Typ B
Frontrahmen metallisch

RRJ_USB_AB

IP65

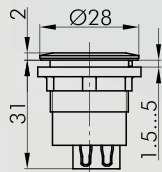

USB-Buchse

vorne:
USB-Buchse: Typ B







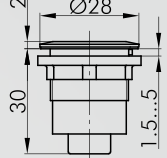

hinten:
USB-Buchse: Typ A
Frontrahmen metallisch

RRJ_USB_BA

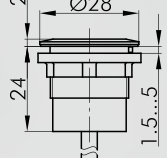
USB-/RJ45-Buchse

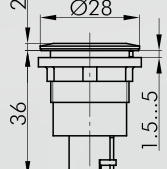
Leuchtvorsatz/Meldeleuchten

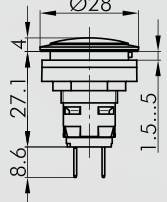
Tasterkappen/Kalotten und Bezeichnungsschilder bitte extra bestellen

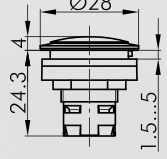
Abbildung	Abmessung	Beschreibung	Type
		<p>USB-Buchse vorne: USB-Buchse: Typ B</p> <p>hinten: USB-Buchse: Typ B Frontrahmen</p>	<p>metallisch</p> <p>RRJ_USB_BB</p>
		<p>RJ45-Buchse vorne: RJ45-Buchse mit Schirm</p> <p>hinten: 60cm Kabel mit RJ45 Stecker geschirmt Frontrahmen</p>	<p>metallisch</p> <p>RRJ_RJ45</p>
		<p>RJ45-Buchse vorne: RJ45-Buchse mit Schirm</p> <p>hinten: RJ45-Buchse mit Schirm Frontrahmen</p>	<p>metallisch</p> <p>RRJ_RJ45_STB</p>
		<p>Meldeleuchte mit Flachsteckanschlüssen 2,8x0,8 mm mit Fassung W2x4,6d</p> <p>Frontrahmen</p>	<p>metallisch</p> <p>RRJL4</p>
		<p>Leuchtvorsatz Frontrahmen</p>	<p>metallisch</p> <p>RRJN</p>

Inhalt
 Befehlsgeräte
 Berührer
 Freilaufverbindungen
 Scherrelle
 Entschalter
 Füllschalter
 Halbleitervorrichtungen

Zubehör Betätiger

Abbildung	Abmessung	Beschreibung	Type
-----------	-----------	--------------	------



Kalotte

in den Farben: BL-blau, GB-gelb, GN-grün, KL-glas-klar, RT-rot, WS-opalweiß
 Kurzbezeichnung an die Type anhängen, z. B. K22RRRT

K22RR...



Bezeichnungsschild unbedruckt

BSRRU



Bezeichnungsschild

mit Standarddruck, bitte Index-Nr. angeben (siehe Bezeichnungsschilder)



BSRR...

Bezeichnungsschild

mit Sonderdruck nach Kundenangabe

BSRRB

Zubehör Betätiger

Abbildung	Abmessung	Beschreibung	Type
		Montageschlüssel Sechskant mit Drehmomentbegrenzung für die Baureihen OKTRON, OKTRON-JUWEL, OKTRON-R, RONTRON-R-JUWEL, RONTRON-R-Exclusive, RONTRON-Q-JUWEL, RONTRON-Q-Exclusive, QUARTRON(-L), QUARTRON-JUWEL(-L), RX, RX-JUWEL	S16
		Montageschlüssel-Adapter mit 1/4-Zoll-Standardanschluss für S16 und S22	SRA
		Außenbezeichnungsträger für selbstklebende Bezeichnungsschilder zur Beschriftung außerhalb der Betätiger passend für RONTRON-R-JUWEL. Von vorne aufrastbar. Farbe transparent	RRJABT
		selbstklebendes Bezeichnungsschild gelasert beschriftet nach Kundenangabe Maße: 22 x 11 mm	BZ16G
		selbstklebendes Bezeichnungsschild leer Maße: 22 x 11 mm	BZ16U
		selbstklebendes Bezeichnungsschild mit Standarddruck, bitte Index-Nr. angeben (siehe Bezeichnungsschilder) Maße: 22 x 11 mm	BZ16B...
		Unterlegschild gelb selbstklebende PVC-Folie Bedruckung auf Anfrage Außen-Ø: 75 mm für Einbauöffnung Ø 22 mm Farbe gelb	NAS_22

 Inhalt
 Betätiger
 Befehlsgeräte
 Freilaufverbindungen
 Scherressen
 Entschalter
 Freilaufschalter
 Halbleiterventile

Ø 22 mm

Zubehör Betätiger

Abbildung	Abmessung	Beschreibung	Type
-----------	-----------	--------------	------



Unterlegschild 4-sprachig bedruckt

selbstklebende PVC-Folie
 Außen-Ø: 75 mm
 für Einbauöffnung Ø 22 mm
 Farbe gelb

NAS_22_548

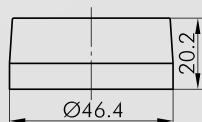

Schutzkragen gelb

für Betätiger mit Einbauöffnung Ø 22 mm
 Farbe gelb

RXJSK



Schutzklappe von vorne aufrastbar

Farbe transparent

KD22RR



plombierbare Schutzklappe

Farbe transparent

KDP22RR

IP67



Schutzklappe aus TPE

Farbe weiß

AK22RR



Lampenzieher

LZ-MG



Universal-Kappenabheber

USK

Zubehör Betätiger

Abbildung	Abmessung	Beschreibung	Type
<p>IP65</p> 		<p>Blindverschluss zum Verschließen vorhandener Einbauöffnungen Frontrahmen metallisch</p>	BVRRJ

- Inhalt
- Wirkprinzip
- Befehlsgerichte
- Betätiger
- Feldbusverbindungen
- Geplante
- Entschalter
- Fallschalter
- Halbleiterventile