



Frontabmessung: Ø 28 mm  
Einbauöffnung: Ø 22 mm  
Frontrahmenhöhe: 2 mm  
Hub: 3 mm



RONTRON-R-JUWEL

Übersicht / Hülsenfarben / Symbolerklärung Baureihe RONTRON-R-JUWEL





01 Drucktasten	Seite 139	USB-Buchsen	Seite 146
02 Not-Aus-Tasten / Not-Halt-Tasten	Seite 140	RJ45-Buchsen	Seite 146
03 Wahltasten	Seite 140		
04 Schlüsseltasten	Seite 143		
05 Akustische Signalgeber	Seite 145		
06 Leuchtensvorsatz / Meldeleuchten	Seite 147		



 Schutzart

 beleuchtbar

 Betätigungshub

 beschriftbar

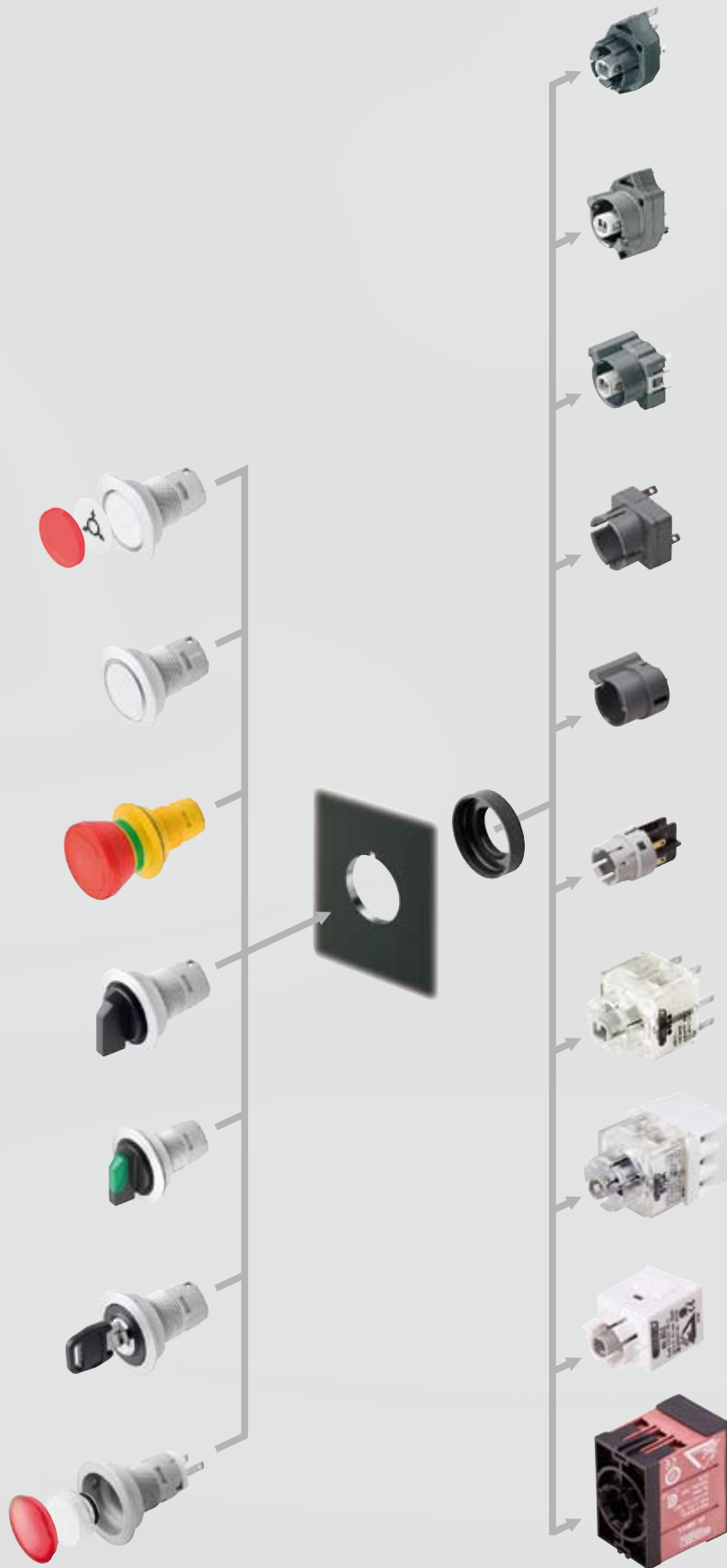

## Einbautiefenmaße

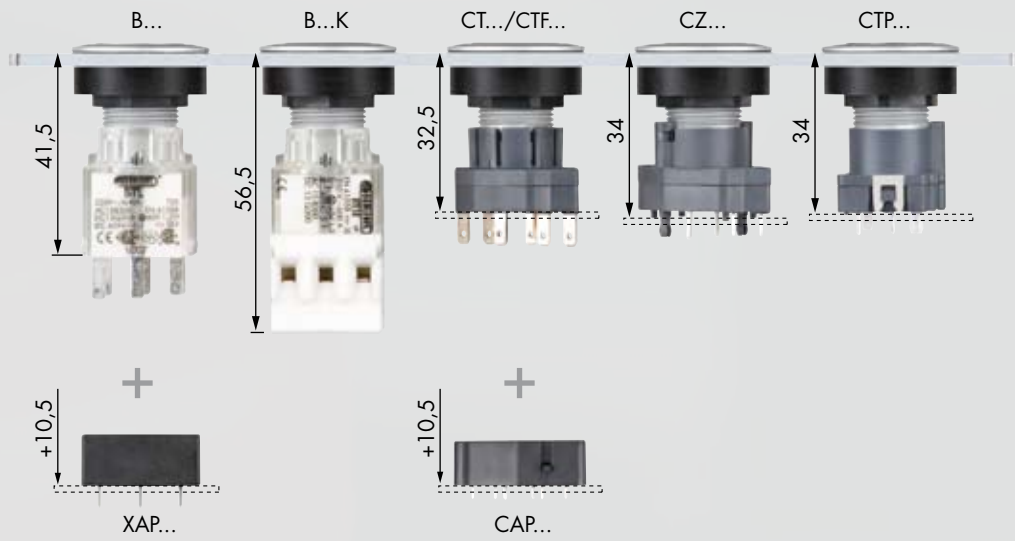

## Maße Einbauöffnung

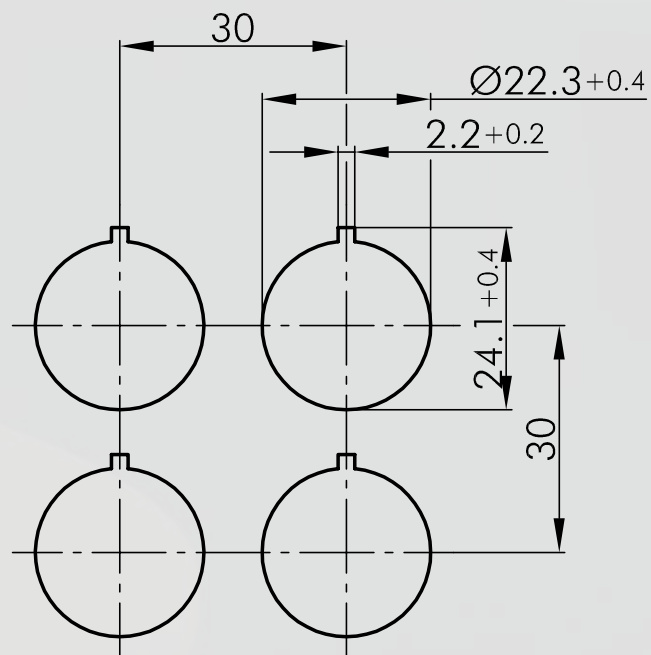

## Montage- und Serviceanweisung

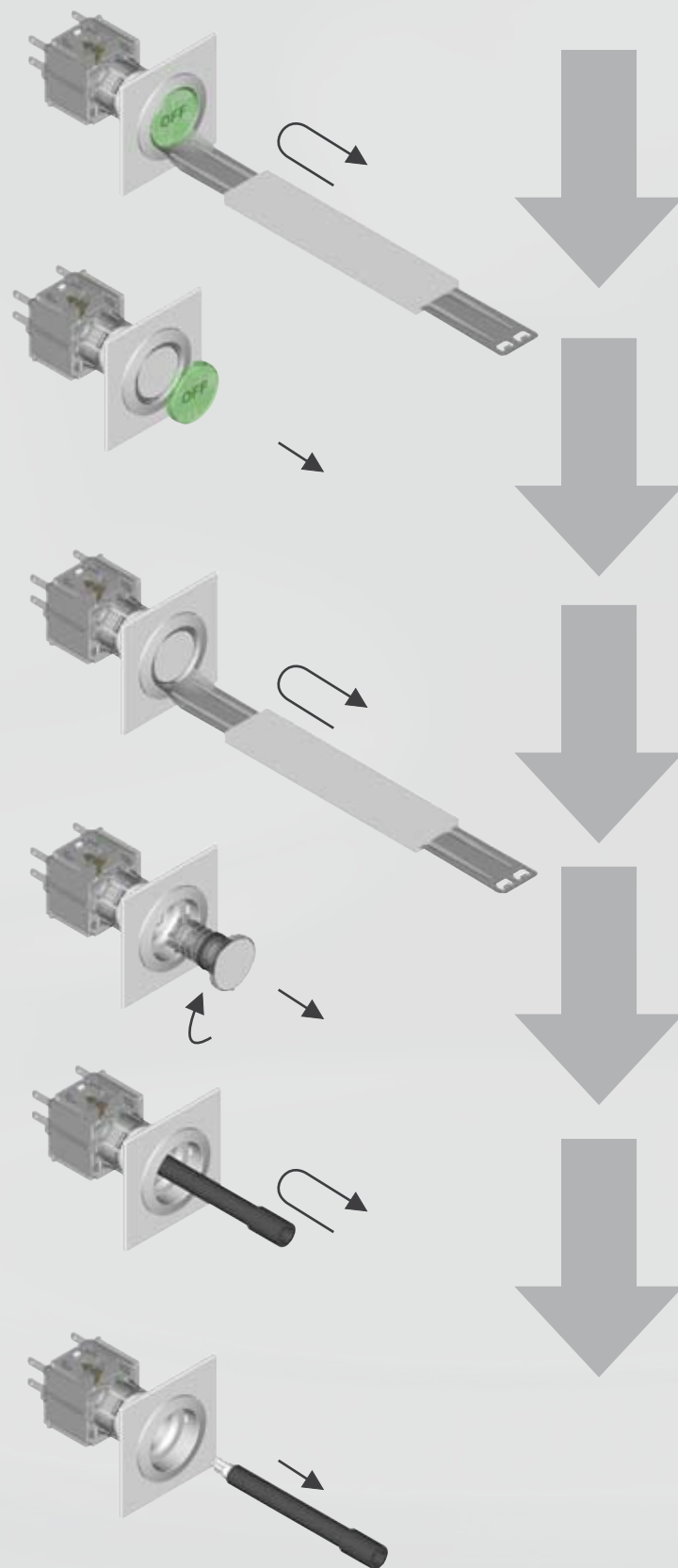

	RRJL4	RRJN	RRJSSA12	RRJSSA13	RRJSSA14	RRJSSA15	RRJSSA16	RRJSSA17	RRJSSA18	RRJSSA23	RRJSSA25	RRJSSA28	RRJSSA31	RRJSTA	RRJSTAL...	RRJSTB	RRJSTBL...	RRJSTB_514	RRJT	RRJTLR	RRJUV	RRJWA	RRJWAL...	RRJWA_514	RRJWB	RRJWBL...	RRJWB_514	RRJWC	RRJWCL...
ASI_BZ																													
ASI_BZL5		●																											
ASI_SAW16A/...E																						●							
AZ2N																							●						
BF(K)																				●									
BFI(K)																				●									
BFL(K)																				●									
BFL5(K)																				●									
BFL5_439																				●									
BFLI(K) / BFLI5(K)																				●									
BFL_439																				●									
BF_439																				●									
BL4(K) / BL5(K)		●																											
BT(K)					●	●	●	●	●			●		●						●			●		●				
BTI(K)					●	●	●	●	●			●		●						●			●		●				
BTL(K) / BTL5(K)		●														●				●			●		●				
BTL5_439																●				●			●		●				
BTLI(K) / BTLI5(K)																●				●			●		●				
BTLO(K) / BTLO5(K)																●				●			●		●				
BTL_439																●				●			●		●				
BTO(K)						●	●	●	●	●		●		●						●			●		●				
BT_439						●	●	●	●	●		●		●						●			●		●				
BZI(K)						●	●	●	●	●		●		●						●			●		●				
BZII(K)			●	●	●	●	●	●	●	●	●	●	●	●	●	●		●		●			●		●		●	●	
BZLI(K) / BZLI5(K)																●				●			●		●				
BZLII(K) / BZLII5(K)																●				●			●		●				●
BZLO(K) / BZLO5(K)																●				●			●		●				
BZLOI(K) / BZLOI5(K)																●				●			●		●				●
BZLOO(K) / BZLOO5(K)																●				●			●		●				●
BZL_439																				●			●		●				●
BZO(K)						●	●	●	●	●		●		●						●			●		●				
BZOI(K)			●	●	●	●	●	●	●	●	●	●	●	●	●	●		●		●			●		●		●	●	
BZOO(K)			●	●	●	●	●	●	●	●	●	●	●	●	●	●		●		●			●		●		●	●	
BZOS(K)																				●									
BZ_439			●	●						●	●		●			●								●				●	
CL		●																											
CLP_485		●																											
CT						●	●	●	●	●		●		●						●			●		●				
CT2			●	●	●	●	●	●	●	●	●	●	●	●	●	●		●		●			●		●		●	●	
CTF						●	●	●	●	●		●		●						●			●		●				
CTL																●				●			●		●				
CTL2																●				●			●		●		●		●
CTLF																●				●			●		●				
CTLP_485																●				●			●		●				
CTP_485							●	●	●	●	●		●		●					●			●		●				
CZLP		●																											
CZTLP																●				●			●		●				
CZTLP2																●		●		●			●		●		●		●
CZTP							●	●	●	●	●		●		●					●			●		●				
CZTP2			●	●	●	●	●	●	●	●	●	●	●	●	●	●		●		●			●		●		●	●	
L4		●																											
PTFOI																						●							
PTFOO																						●							
PTFPOI																						●							
PTFPOO																						●							
PTPOI																						●							
PTPOO																						●							

**Drucktaste (tastend/schaltend)**

Tasterkappen/Kalotten und Bezeichnungsschilder bitte extra bestellen

Abbildung	Abmessung	Beschreibung	Type
  	<p><b>Drucktaste</b> Frontrahmen      metallisch</p>	<b>RRJT</b>	
	<p><b>Tasterkappe, flach, transparent</b> Farben: BL-blau, GB-gelb, GN-grün, KL-glasklar, RT-rot, WS-opalweiß Kurzbezeichnung an die Type anhängen, z. B. T22RRBL</p>	<b>T22RR...</b>	
	<p><b>Tasterkappe, flach, gedeckt</b> Ausführung für unbeschriftete Tasten (nicht beleuchtbar). Farben: BL-blau, GB-gelb, GN-grün, SW-schwarz, RT-rot, WS-weiß Kurzbezeichnung an die Type anhängen, z. B. T22RRGWS</p>	<b>T22RRG...</b>	
	<p><b>Bezeichnungsschild unbedruckt</b></p>	<b>BSRRU</b>	
	<p><b>Bezeichnungsschild</b> mit Standarddruck, bitte Index-Nr. angeben (siehe Bezeichnungsschilder)</p>	<b>BSRR...</b>	
	<p><b>Bezeichnungsschild</b> mit Sonderdruck nach Kundenangabe</p>	<b>BSRRB</b>	
  	<p><b>Drucktaste mit Ringbeleuchtung</b> inkl. Tasterkappe, Beschriftung auf Anfrage Frontrahmen      metallisch</p>	<b>RRJTLR</b>	

Inhalt  
 Warten  
 Befehlsgeräte  
 Betreuer  
 Freilaufverbindungen  
 Scherisse  
 Entschalter  
 Freilaufschalter  
 Halbleitungen



Ø 22 mm

**Not-Halt/Not-Aus-Taste**  
**Potentiometer-Antrieb**  
**Wahltaste (tastend/schaltend)**

I = Schaltstellung  
 > = Federrückzug

Abbildung

Abmessung

Beschreibung

Type

IP65

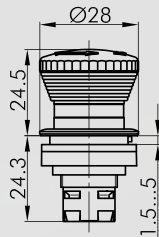

**Not-Aus-Taste**



überlistsicher Ja  
 Schaltstellungsanzeige Ja  
 Blockierschutzkragen Nein  
 Entriegelung Rechts- und Linksdrehung  
 Norm EN 60947-5-1, EN 60947-5-5, EN 60068, EN 13850  
 Pilzknopf rot  
 Frontrahmen gelb

**RRJUV**



**Weitere Not-Halt/Not-Aus-Tasten finden Sie in der Rubrik „Not-Halt/Not-Aus-Tasten“**

Die Not-Halt/Not-Aus-Tasten sind auch mit anderen Pilzknopffarben als verrastbare Pilztasten lieferbar.

IP65

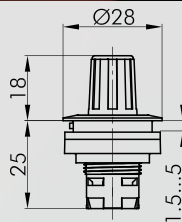

**Potentiometer-Antrieb**

Mit Drehgriff, jedoch ohne Poti. Für Poti mit 6 mm Achsendurchmesser und Gewinde M10 x 0,75.  
 Achsenlänge: ca. 32 mm  
 Frontrahmen metallisch

**RRJR**

IP65

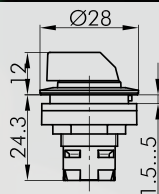

**Wahltaste**

Frontrahmen metallisch



**RRJWA**

IP65

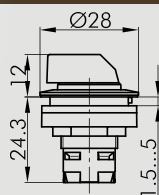

**Wahltaste**

Frontrahmen metallisch

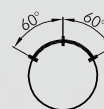

**RRJWB**

**Wahltaste (tastend/schaltend)**

I = Schaltstellung  
> = Federrückzug

Abbildung

Abmessung

Beschreibung

Type

IP65

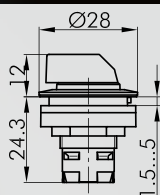

**Wahltaste**  
Frontrahmen

metallisch

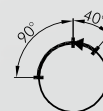

**RRJWC**

IP65

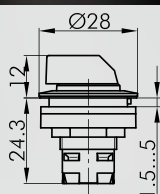

**Schwenktaste**  
Frontrahmen

metallisch



**RRJSTA**

IP65

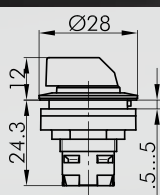

**Schwenktaste**  
Frontrahmen

metallisch



**RRJSTB**

IP65

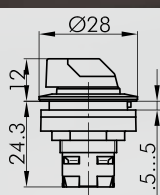

**Leucht-Wahltaste**

Knebefarben: BL-blau, GB-gelb, KL-glasklar, GN-grün, RT-rot (z.B. RRJWAL\_GN)  
Frontrahmen

metallisch



**RRJWAL...**

IP65

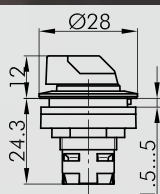

**Leucht-Wahltaste**

Knebefarben: BL-blau, GB-gelb, KL-glasklar, GN-grün, RT-rot (z.B. RRJWBL\_GN)  
Frontrahmen

metallisch

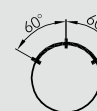

**RRJWBL...**

IP65

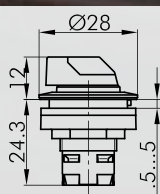

**Leucht-Wahltaste**

Knebefarben: BL-blau, GB-gelb, KL-glasklar, GN-grün, RT-rot (z.B. RRJWCL\_GN)  
Frontrahmen

metallisch



**RRJWCL...**

Ø 22 mm

**Wahltaste (tastend/schaltend)**

I = Schaltstellung  
> = Federrückzug

Abbildung

Abmessung

Beschreibung

Type

IP65

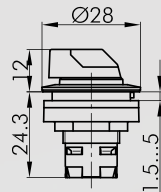

**Leucht-Schwenktaste**

Knebefarben: BL-blau, GB-gelb, KL-glasklar, GN-grün, RT-rot (z.B. RRJSTAL\_GN)  
Frontrahmen metallisch



**RRJSTAL...**

IP65

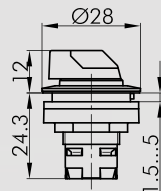

**Leucht-Schwenktaste**

Knebefarben: BL-blau, GB-gelb, KL-glasklar, GN-grün, RT-rot (z.B. RRJSTBL\_GN)  
Frontrahmen metallisch



**RRJSTBL...**

IP65



**wüstentaugliche Wahl-taste**

geprüft mit Arizona-Staub grob  
Knebefarbe schwarz  
Frontrahmen metallisch



**RRJWA\_514**

IP65



**wüstentaugliche Wahl-taste**

geprüft mit Arizona-Staub grob  
Knebefarbe schwarz  
Frontrahmen metallisch



**RRJWB\_514**

IP65



**wüstentaugliche Wahl-taste**









geprüft mit Arizona-Staub grob  
Knebefarbe schwarz  
Frontrahmen metallisch

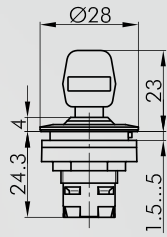
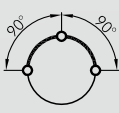

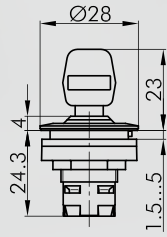
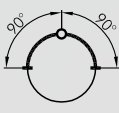
**RRJSTB\_514**

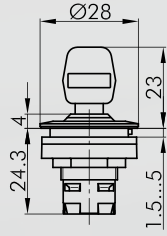
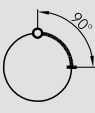
**Schlüsseltaste (tastend/schaltend)**

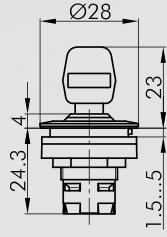
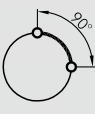
- I = Schaltstellung
- > = Federrückzug
- = Schlüsselabzugstellung

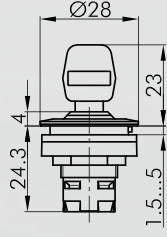
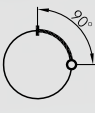
Abbildung	Abmessung	Beschreibung	Type
		<p><b>Schlüsseltaste</b> inkl. zwei Schlüssel verschiedenschließend möglich, Mehrpreis a. A. Frontrahmen metallisch</p>	 <p><b>RRJSSA12</b></p>
		<p><b>Schlüsseltaste</b> inkl. zwei Schlüssel verschiedenschließend möglich, Mehrpreis a. A. Frontrahmen metallisch</p>	 <p><b>RRJSSA13</b></p>
		<p><b>Schlüsseltaste</b> inkl. zwei Schlüssel verschiedenschließend möglich, Mehrpreis a. A. Frontrahmen metallisch</p>	 <p><b>RRJSSA14</b></p>
		<p><b>Schlüsseltaste</b> inkl. zwei Schlüssel verschiedenschließend möglich, Mehrpreis a. A. Frontrahmen metallisch</p>	 <p><b>RRJSSA15</b></p>
		<p><b>Schlüsseltaste</b> inkl. zwei Schlüssel verschiedenschließend möglich, Mehrpreis a. A. Frontrahmen metallisch</p>	 <p><b>RRJSSA16</b></p>

Inhalt  
 Befehlsgeräte  
 Berührer  
 Freilaufverbindungen  
 Scherrelle  
 Entschalter  
 Fallschalter  
 Halbleiterventile

# RONTRON-R-JUWEL

Ø 22 mm

## Schlüsseltaste (tastend/schaltend)

- I = Schaltstellung
- > = Federrückzug
- = Schlüsselabzugstellung

Abbildung	Abmessung	Beschreibung	Type
		<b>Schlüsseltaste</b> inkl. zwei Schlüssel verschiedenschließend möglich, Mehrpreis a. A. Frontrahmen metallisch	 <b>RRJSSA17</b>
		<b>Schlüsseltaste</b> inkl. zwei Schlüssel verschiedenschließend möglich, Mehrpreis a. A. Frontrahmen metallisch	 <b>RRJSSA18</b>
		<b>Schlüsseltaste</b> inkl. zwei Schlüssel verschiedenschließend möglich, Mehrpreis a. A. Frontrahmen metallisch	 <b>RRJSSA23</b>
		<b>Schlüsseltaste</b> inkl. zwei Schlüssel verschiedenschließend möglich, Mehrpreis a. A. Frontrahmen metallisch	 <b>RRJSSA25</b>
		<b>Schlüsseltaste</b> inkl. zwei Schlüssel verschiedenschließend möglich, Mehrpreis a. A. Frontrahmen metallisch	 <b>RRJSSA28</b>

**Schlüsseltaste (tastend/schaltend)  
Akustischer Signalgeber**

- I = Schaltstellung
- > = Federrückzug
- = Schlüsselabzugstellung

Abbildung

Abmessung

Beschreibung

Type

IP65

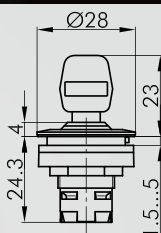

**Schlüsseltaste**

inkl. drei Schlüssel

- 1. Schlüssel: Rechts-Links-Betätigung
  - 2. Schlüssel: nur Links-Betätigung
  - 3. Schlüssel: nur Rechts-Betätigung
- Frontrahmen metallisch

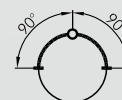

**RRJSSA31**



**Ersatzschlüssel**

bitte Schlüsselnr. angeben

**ESMIC...**

IP65

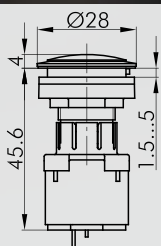

**Akustischer Signalgeber**

Betriebsspannung: 12 ... 24V AC/DC  
 Betriebsstrom: max. 30mA  
 Signalfrequenz: 3,5 +/- 0,5 kHz  
 Lautstärke: max. 87 db (10cm, 24V)  
 max. 85 db (10cm, 12V)  
 Betriebstemperatur: -20°C ... 60°C  
 Frontrahmen metallisch

**RRJNSG+SG-24V**

IP65

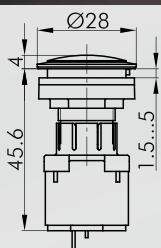

**Akustischer Intervall-Signalgeber**

Betriebsspannung: 12 ... 24V AC/DC  
 Betriebsstrom: max. 30mA  
 Signalfrequenz: 3,5 +/- 0,5 kHz  
 Lautstärke: max. 87 db (10cm, 24V)  
 max. 85 db (10cm, 12V)  
 Intervall: 1s  
 Betriebstemperatur: -20°C ... 60°C  
 Frontrahmen metallisch

**RRJNSG+SGI-24V**



**Flachsteckhülse 2,8 x 0,8 mm mit Rastzunge**

**FH2,8**

Querschnittsbereich 0,75 - 1,50 mm<sup>2</sup>, Messing, mit Rastzunge zum Einrasten in Anschlussstecker XA, XAL und IH2,8



**Isolierstoffhülse**

**IH2,8**

für Flachsteckhülse FH2,8, von vorne aufsteckbar

Inhalt  
 Befehlsgeräte  
 Betätiger  
 Freilaufverbindungen  
 Scherressen  
 Entschalter  
 Freilaufschalter  
 Halbleitervorrichtungen

Ø 22 mm

## USB-/RJ45-Buchse

Abbildung

Abmessung

Beschreibung

Type



### Flachsteckverteiler

**FD2,8**

zum Anschließen von 2 Flachsteckhülsen FH2,8 an einer Flachsteckzunge 2,8 x 0,8 mm

IP65

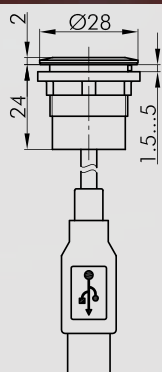

### USB-Buchse

vorne:  
USB-Buchse: Typ A

hinten:  
USB2.0 - Kabel (Länge 60 cm) mit Stecker Typ A  
Frontrahmen metallisch

**RRJ\_USB**

IP65

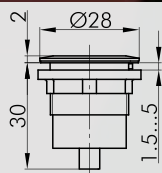

### USB-Buchse

vorne:  
USB-Buchse: Typ A

hinten:  
USB-Buchse: Typ A  
Frontrahmen metallisch

**RRJ\_USB\_AA**

IP65

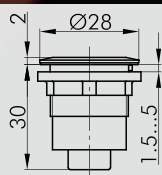

### USB-Buchse

vorne:  
USB-Buchse: Typ A

hinten:  
USB-Buchse: Typ B  
Frontrahmen metallisch

**RRJ\_USB\_AB**

IP65

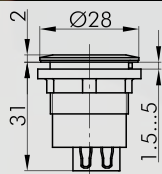

### USB-Buchse

vorne:  
USB-Buchse: Typ B

hinten:  
USB-Buchse: Typ A  
Frontrahmen metallisch

**RRJ\_USB\_BA**

## USB-/RJ45-Buchse

### Leuchtvorsatz/Meldeleuchten

Tasterkappen/Kalotten und Bezeichnungsschilder bitte extra bestellen

Abbildung

Abmessung

Beschreibung

Type

IP65

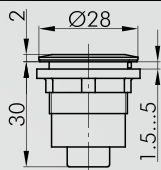

### USB-Buchse

vorne:  
USB-Buchse: Typ B

hinten:  
USB-Buchse: Typ B  
Frontrahmen

metallisch

**RRJ\_USB\_BB**

IP65

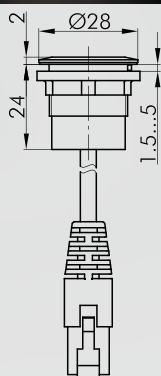

### RJ45-Buchse

vorne:  
RJ45-Buchse mit Schirm

hinten:  
60cm Kabel mit RJ45 Stecker geschirmt  
Frontrahmen

metallisch

**RRJ\_RJ45**

IP50

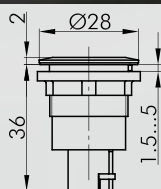

### RJ45-Buchse

vorne:  
RJ45-Buchse mit Schirm

hinten:  
RJ45-Buchse mit Schirm  
Frontrahmen

metallisch

**RRJ\_RJ45\_STB**

IP65

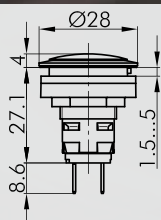

### Meldeleuchte mit Flachsteckanschlüssen 2,8x0,8 mm

mit Fassung W2x4,6d

Frontrahmen

metallisch

**RRJL4**

IP65

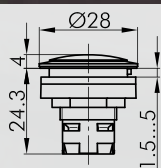

### Leuchtvorsatz

Frontrahmen

metallisch

**RRJN**



## Zubehör Betätiger

Abbildung	Abmessung	Beschreibung	Type
-----------	-----------	--------------	------



### Kalotte

in den Farben: BL-blau, GB-gelb, GN-grün, KL-glas-klar, RT-rot, WS-opalweiß  
 Kurzbezeichnung an die Type anhängen, z. B. K22RRRT

**K22RR...**



### Bezeichnungsschild unbedruckt

**BSRRU**



### Bezeichnungsschild

mit Standarddruck, bitte Index-Nr. angeben (siehe Bezeichnungsschilder)

**BSRR...**

### Bezeichnungsschild

mit Sonderdruck nach Kundenangabe

**BSRRB**

## Zubehör Betätiger

Abbildung	Abmessung	Beschreibung	Type
		<b>Montageschlüssel</b> Sechskant mit Drehmomentbegrenzung für die Baureihen OKTRON, OKTRON-JUWEL, OKTRON-R, RONTRON-R-JUWEL, RONTRON-R-Exclusive, RONTRON-Q-JUWEL, RONTRON-Q-Exclusive, QUARTRON(-L), QUARTRON-JUWEL(-L), RX, RX-JUWEL	<b>S16</b>
		<b>Montageschlüssel-Adapter mit 1/4-Zoll-Standardanschluss</b> für S16 und S22	<b>SRA</b>
		<b>Außenbezeichnungsträger</b> für selbstklebende Bezeichnungsschilder zur Beschriftung außerhalb der Betätiger passend für RONTRON-R-JUWEL. Von vorne aufrastbar. Farbe transparent	<b>RRJABT</b>
		<b>selbstklebendes Bezeichnungsschild gelasert</b> beschriftet nach Kundenangabe Maße: 22 x 11 mm	<b>BZ16G</b>
		<b>selbstklebendes Bezeichnungsschild leer</b> Maße: 22 x 11 mm	<b>BZ16U</b>
		<b>selbstklebendes Bezeichnungsschild</b> mit Standarddruck, bitte Index-Nr. angeben (siehe Bezeichnungsschilder) Maße: 22 x 11 mm	<b>BZ16B...</b>
		<b>Unterlegschild gelb</b> selbstklebende PVC-Folie Bedruckung auf Anfrage Außen-Ø: 75 mm für Einbauöffnung Ø 22 mm Farbe gelb	<b>NAS_22</b>

Inhalt  
 Betätiger  
 Befehlsgeräte  
 Freilaufverbindungen  
 Scherapparat  
 Entschalter  
 Freilaufschalter  
 Halbleiterventile

Ø 22 mm

## Zubehör Betätiger

Abbildung	Abmessung	Beschreibung	Type
-----------	-----------	--------------	------



### Unterlegschild 4-sprachig bedruckt

selbstklebende PVC-Folie  
 Außen-Ø: 75 mm  
 für Einbauöffnung Ø 22 mm  
 Farbe gelb

**NAS\_22\_548**

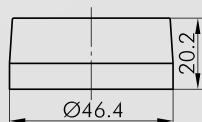

### Schutzkragen gelb

für Betätiger mit Einbauöffnung Ø 22 mm  
 Farbe gelb

**RXJSK**



### Schutzklappe von vorne aufrastbar

Farbe transparent

**KD22RR**



### plombierbare Schutzklappe

Farbe transparent

**KDP22RR**

IP67



### Schutzklappe aus TPE

Farbe weiß

**AK22RR**

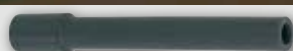

### Lampenzieher

**LZ-MG**



### Universal-Kappenabheber

**USK**

## Zubehör Betätiger

Abbildung	Abmessung	Beschreibung	Type
		<b>Blindverschluss</b> zum Verschließen vorhandener Einbauöffnungen Frontrahmen                      metallisch	<b>BVRRJ</b>

- Inhalt
- Wirkprinzip
- Befehlsgerichte
- Betätiger
- Feldbusverbindungen
- Geräte
- Entschalter
- Fallschalter
- Halbleiterventile