

BAUREIHE 1830 - EIN- UND ZWEIPOLIGE WIPPSCHALTER

BIS 20 (4) A 250 V AC





PRODUKTMERKMALE

- ◆ 100-millionenfach bewährtes Schaltprinzip
- ◆ Mechanische Lebensdauer bis 1 Mio. Schaltzyklen
- ◆ Hohe Variantenvielfalt
- ◆ Varianten mit IP 67 oder Staubschutzeinlage
- ◆ Zwei Gehäusevarianten
- ◆ Ausgeprägte Betätigungscharakteristik
- ◆ Beleuchtete und unbeleuchtete Varianten
- ◆ Zulassung für 400 V (produktabhängig)

AUF ANFRAGE





























- ◆ Weitere Farben
- ◆ Weitere Wippenbedruckungen
- ◆ Weitere Leuchtenvarianten
- ◆ Aufrastbare kundenspezifische Betätiger
- ◆ Kabelkonfektion

Mechanische Lebensdauer	10E4 5E4 (Grundtyp 1839) 1E6 (produktabhängig)
Einschaltspitzenstrom	120 A / 50 A (Kontaktpaarung Ag / Cu)
Übergangswiderstand (Neuzustand)	< 100 mOhm (1 A 12 V DC)
Isolationswiderstand (Neuzustand)	> 100 MOhm (500 V DC)
Spannungsfestigkeit bei 250 V	1 500 V Funktionsisolierung / Basisisolierung 3 000 V verstärkte Isolierung 500 V kleiner Kontaktabstand
Kriechstromfestigkeit	250 PTI
Isolationsabstand	nach EN 61058 für verstärkte bzw. doppelte Isolierung
Schutzart	IP 40 / IP 67 (produktabhängig)
Umgebungstemperatur	Anschlussseite -20 °C ... +105 °C / ... +85 °C / ... +100 °C Betätigungsseite -20 °C ... +55 °C
Entflammbarkeit	UL 94 V-2 und UL 94 V-0 (produktabhängig)
Wärme- und Feuerbeständigkeit	850 °C (Kategorie D)
Material	Betätiger PA / PC Gehäuse PA Anschlüsse versilbert / verzinkt
Aufsteckkraft der Steckhülsen	≤ 80 N
Prüfzeichen	  
Geeignet für Geräte der Schutzklasse II	



BAUREIHE 1830 - EIN- UND ZWEIPOLIGE WIPPSCHALTER





























BIS 20 (4) A 250 V AC

	Ausschalter (SPST)							Wechsler (SPDT Momentary)						
	1830.3111	1830.3112	1830.3118	1830.3119	1830.8112	1830.0102	1830.6103	1835.3902	1831.0112	1831.0114	1831.0115	1831.3312	1831.3313	1831.3317
Spannung Leuchte in V	230	230	230	230	230	230	230	230						
Betätigerfarbe / Bedruckung														
Gehäusefarbe														
20 (4) A 250 V AC 1E4	•	•	•	•	•				•	•	•	•	•	•
16 (4) A 250 V AC 1E4														
10 (8) A 250 V AC 5E4	•	•	•	•	•				•	•	•	•	•	•
10 (4) A 250 V AC 1E4						•	•							
10 A 12 V DC														
6 (4) A 250 V AC 5E4						•	•							
6 (4) A 250 V AC 1E4														
6 (4) A 250 V AC														
4 (2) A 250 V AC 1E4								•						
30 mA 12 V DC														
16 A 250 V AC 1 HP	•	•	•	•	•				•	•	•	•	•	•
16 A 125 V AC 1 HP														
16 A 250 V AC 1/2 HP									•	•	•	•	•	•
16 A 125 V AC 1/3 HP														
16 A 125 V AC 1/4 HP														
6 A 250 V AC 1/2 HP						•	•							
6 A 125 V AC 1/4 HP														
6 A 125 - 250 V AC 1/8 HP														
6 A 125 V AC 1/10 HP								•						
4 A 250 V AC 1/10 HP								•						
Anschlussart														
Anschlussbeschreibung	6.3	6.3	6.3	6.3	6.3	6.3	4.8	6.3	6.3	6.3	6.3	6.3	6.3	6.3
Kontaktabstand in mm	≥ 3	≥ 3	≥ 3	≥ 3	≥ 3	≥ 3	≥ 3	≥ 3	≥ 3	≥ 3	≥ 3	≥ 3	≥ 3	≥ 3
Kontaktmaterial	Ag	Ag	Ag	Ag	Ag	Ag	Ag	Ag	Ag	Ag	Ag	Ag	Ag	Ag
EN 60335 Kap. 30 konform „G“				•										•
Sonstiges					tieferliegender Flansch		tieferliegender Flansch	zweipolige Baugröße externer Leuchtenanschluss						
Lagervariante	•	•	•	•	•	•			•			•	•	

WIPPSCHALTER
DRUCKSCHALTER
KIPPSCHALTER
SCHIEBESCHALTER
DREHSCHALTER
FUSSSCHALTER
WENKZEUGSCHALTER
TASTEN
SCHNAPPSCHALTER
MIKRO-SIGNALSCHALTER
SENSOREN

BAUREIHE 1830 - EIN- UND ZWEIPOLIGE WIPPSCHALTER

BIS 20 (4) A 250 V AC

	Ausschalter (SPST)								Schließer (SPNO)				Umschalter (SPDT)	
	1831.3606	1831.3607	1831.3815	1831.3933	1831.8112	1831.1107	1831.7102	1831.8102	1831.1202	1831.3402	1831.8202	1831.1253	1833.3312	1833.1102
Spannung Leuchte in V														
Betätigerfarbe / Bedruckung														
Gehäusefarbe	black	black	black	black	black	black	black	black	black	black	black	black	black	black
20 (4) A 250 V AC 1E4	•	•	•	•	•									
16 (4) A 250 V AC 1E4													•	
10 (8) A 250 V AC 5E4	•	•	•	•	•									
10 (4) A 250 V AC 1E4						•	•	•						•
10 A 12 V DC														
6 (4) A 250 V AC 5E4						•	•	•						•
6 (4) A 250 V AC 1E4														
6 (4) A 250 V AC														
4 (2) A 250 V AC 1E4									•	•	•			
30 mA 12 V DC											•			
16 A 250 V AC 1 HP	•	•	•	•	•									
16 A 125 V AC 1 HP														
16 A 250 V AC 1/2 HP													•	
16 A 125 V AC 1/3 HP	•	•	•	•	•									
16 A 125 V AC 1/4 HP													•	
6 A 250 V AC 1/2 HP						•	•	•						•
6 A 125 V AC 1/4 HP						•	•	•						•
6 A 125 - 250 V AC 1/8 HP														
6 A 125 V AC 1/10 HP									•	•	•			
4 A 250 V AC 1/10 HP									•	•	•			
Anschlussart														
Anschlussbeschreibung	6.3	6.3	6.3	6.3	6.3	4.8	6.3	4.8	6.3	6.3	6.3	4.8	6.3	4.8
Kontaktabstand in mm	≥ 3	≥ 3	≥ 3	≥ 3	≥ 3	≥ 3	≥ 3	≥ 3	≥ 3	≥ 3	≥ 3	≥ 3	≥ 3	≥ 3
Kontaktmaterial	Ag	Ag	Ag	Ag	Ag	Ag	Ag	Ag	Ag	Ag	Ag	Au	Ag	Ag
EN 60335 Kap. 30 konform „G“	•	•												
Sonstiges	Gehäuse mit 2 Trennstegen	Gehäuse mit 2 Trennstegen	IP 67 1E6 mechanische Schaltzyklen		tieferliegender Flansch	tieferliegender Flansch	tieferliegender Flansch				tieferliegender Flansch			
Lagervariante				•	•	•			•	•	•			•

WIPPSCHALTER

DRUCKSCHALTER

KIPPSCHALTER

SCHIEBESCHALTER

DREHSCHALTER

FUSSSCHALTER

WERKZEUGSCHALTER

TASTEN

































SCHNAPPSCHALTER

MIKRO-SIGNALSCHALTER

SENSOREN

BAUREIHE 1830 - EIN- UND ZWEIPOLIGE WIPPSCHALTER

BIS 20 (4) A 250 V AC



einpolig		Umschalter (SPDT)			Umschalter mit AUS-Stellung in der Mitte (SPDT - Center OFF)												
 		1833.3307	1833.7102	1833.8102	1838.0305	1838.3412	1838.3512	1838.3901	1838.1402	1838.1502	1838.1509	1838.1602	1838.4307	1838.7203	1838.8302	1838.3402	
Spannung Leuchte in V																	
Betätigerfarbe / Bedruckung																	
Gehäusefarbe		■	■	■	■	■	■	■	■	■	■	■	■	■	■	■	
20 (4) A 250 V AC 1E4																	
16 (4) A 250 V AC 1E4					●	●	●	●									
10 (8) A 250 V AC 5E4																	
10 (4) A 250 V AC 1E4		●	●	●													
10 A 12 V DC																	
6 (4) A 250 V AC 5E4		●	●	●													
6 (4) A 250 V AC 1E4									●	●	●	●	●	●	●	●	
6 (4) A 250 V AC																●	
4 (2) A 250 V AC 1E4																	
30 mA 12 V DC																	
16 A 250 V AC 1 HP																	
16 A 125 V AC 1 HP																	
16 A 250 V AC 1/2 HP					●	●	●	●									
16 A 125 V AC 1/3 HP					●	●	●	●									
16 A 125 V AC 1/4 HP																	
6 A 250 V AC 1/2 HP		●	●	●													
6 A 125 V AC 1/4 HP		●	●	●													
6 A 125 - 250 V AC 1/8 HP									●	●	●	●	●	●	●	●	
6 A 125 V AC 1/10 HP																	
4 A 250 V AC 1/10 HP																	
Anschlussart																	
Anschlussbeschreibung		6.3		6.3				6.3	4.8	4.8	4.8	4.8	2.8		6.3	6.3	
Kontaktabstand in mm		≥ 3	≥ 3	≥ 3	≥ 3	≥ 3	≥ 3	≥ 3	≥ 3	≥ 3	≥ 3	≥ 3	≥ 3	≥ 3	≥ 3	≥ 3	
Kontaktmaterial		Ag	Ag	Ag	Ag	Ag	Ag	Ag	Ag	Ag	Ag	Ag	Ag	Ag	Ag	Ag	
EN 60335 Kap. 30 konform „G“		●															
Sonstiges			tieferliegender Flansch	tieferliegender Flansch	Tastfunktion beidseitig	Tastfunktion beidseitig		IP 67 1E6 mechanische Schaltzyklen	Tastfunktion beidseitig			Tastfunktion einseitig	Tastfunktion einseitig	Tastfunktion einseitig tieferliegender Flansch	Tastfunktion beidseitig tieferliegender Flansch	Tastfunktion beidseitig	
Lagervariante		●		●			●	●	●	●		●			●	●	

WIPPSCHALTER
DRUCKSCHALTER
KIPPSCHALTER
SCHIEBESCHALTER
DREHSCHALTER
FUSSSCHALTER
WENZUEGELSCHALTER
TASTEN
SCHNIPPSCHALTER
MIKRO-SIGNALSCHALTER
SENSOREN

BAUREIHE 1830 - EIN- UND ZWEIPOLIGE WIPPSCHALTER

BIS 20 (4) A 250 V AC

- WIPPSCHALTER
- DRUCKSCHALTER
- KIPPSCHALTER
- SCHIEBESCHALTER
- DREHSCHALTER
- FUSSSCHALTER
- WERKZEUGSCHALTER
- TASTEN
- SCHNAPPSCHALTER
- MIKRO-SIGNALSCHALTER
- SENSOREN

einpolig	1838.3502	1833.1202	1833.3402	1833.6206
 				
Spannung Leuchte in V				
Betätigerfarbe / Bedruckung	●	●	●	●
Gehäusefarbe	■	■	■	■
20 (4) A 250 V AC 1E4				
16 (4) A 250 V AC 1E4				
10 (8) A 250 V AC 5E4				
10 (4) A 250 V AC 1E4				
10 A 12 V DC				
6 (4) A 250 V AC 5E4				
6 (4) A 250 V AC 1E4				
6 (4) A 250 V AC	●			
4 (2) A 250 V AC 1E4		●	●	●
30 mA 12 V DC				
16 A 250 V AC 1 HP				
16 A 125 V AC 1 HP				
16 A 250 V AC 1/2 HP				
16 A 125 V AC 1/3 HP				
16 A 125 V AC 1/4 HP				
6 A 250 V AC 1/2 HP				
6 A 125 V AC 1/4 HP				
6 A 125 - 250 V AC 1/8 HP	●			
6 A 125 V AC 1/10 HP		●	●	●
4 A 250 V AC 1/10 HP		●	●	●
Anschlussart	⏏	⏏	⏏	⏏
Anschlussbeschreibung	6.3	4.8	6.3	4.8
Kontaktabstand in mm	≥ 3	≥ 3	≥ 3	≥ 3
Kontaktmaterial	Ag	Ag	Ag	Ag
EN 60335 Kap. 30 konform „G“				
Sonstiges				tieferliegender Flansch
Lagervariante	●		●	





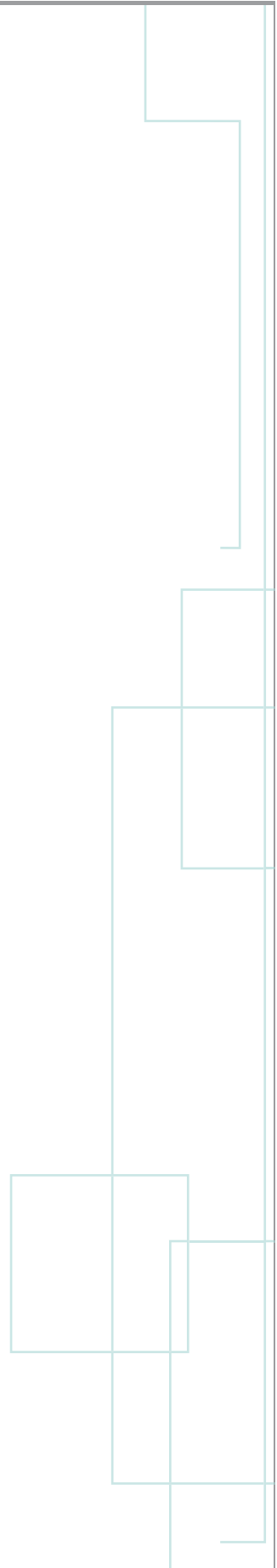

























Umschalter mit AUS-Stellung in der Mitte (SPDT - Center OFF)

Wechsler (SPDT Momentary)



BAUREIHE 1830 - EIN- UND ZWEIPOLIGE WIPPSCHALTER

BIS 20 (4) A 250 V AC

zweipolig																	
																	
		Ausschalter (DPST)															
		1835.3419	1835.3111	1835.3112	1835.3114	1835.3118	1835.3418	1835.9413	1835.1115	1835.7108	Umschalter (DPDT)	1835.3802	Ausschalter (DPST)				
Spannung Leuchte in V		400	230	230	230	230	230	230	230	230		230	115-230	12			
Betätigerfarbe / Bedruckung																	
Gehäusefarbe		Black	Black	Black	Black	Black	Black	Black	Black	Black	Black	Black	Black	Black	Black	Black	Black
20 (4) A 250 V AC 1E4		•	•	•	•	•	•	•					•		•	•	
16 (4) A 250 V AC 1E4																	
10 (8) A 250 V AC 5E4		•	•	•	•	•	•	•					•		•	•	
10 (4) A 250 V AC 1E4									•	•		•					
10 A 12 V DC													•				
6 (4) A 250 V AC 5E4									•	•		•					
6 (4) A 250 V AC 1E4																	
6 (4) A 250 V AC																	
4 (2) A 250 V AC 1E4																	
30 mA 12 V DC																	
16 A 250 V AC 1 HP		•	•	•	•	•	•	•					•		•	•	
16 A 125 V AC 1 HP																	
16 A 250 V AC 1/2 HP																	
16 A 125 V AC 1/3 HP															•	•	
16 A 125 V AC 1/4 HP																	
6 A 250 V AC 1/2 HP									•	•		•					
6 A 125 V AC 1/4 HP																	
6 A 125 - 250 V AC 1/8 HP																	
6 A 125 V AC 1/10 HP																	
4 A 250 V AC 1/10 HP																	
Anschlussart																	
Anschlussbeschreibung		6.3	6.3	6.3	6.3	6.3	6.3	6.3	4.8	4.8		6.3	6.3	6.3	4.8	6.3	
Kontaktabstand in mm		≥ 3	≥ 3	≥ 3	≥ 3	≥ 3	≥ 3	≥ 3	≥ 3	≥ 3		≥ 3	≥ 3	≥ 3	≥ 3	≥ 3	
Kontaktmaterial		Ag	Ag	Ag	Ag	Ag	Ag	Ag	Ag	Ag		Ag	Ag	Ag	Ag	Ag	
EN 60335 Kap. 30 konform „G“																	
Sonstiges		10 (8) 400 V AC 5E4 Abdeckrahmen 33.2 lang					Abdeckrahmen 33.2 lang	LPE-Halterung 248.103.011 montiert tieferliegender Flansch		tieferliegender Flansch					Abdeckrahmen 33.2 lang		
Lagervariante			•	•	•	•		•						•		•	

WIPPSCHALTER
DRUCKSCHALTER
KIPPSCHALTER
SCHIEBESCHALTER
DREHSCHALTER
FUSSSCHALTER
WENKZEUGSCHALTER
TASTEN
SCHNIPPSCHALTER
MIKRO-SIGNALSCHALTER
SENSOREN

BAUREIHE 1830 - EIN- UND ZWEIPOLIGE WIPPSCHALTER

BIS 20 (4) A 250 V AC

zweipolig		Ausschalter (DPST)										Schließer (DPNO)		Umschalter (DPDT)	
		1832.3312	1832.3313	1832.3508	1832.3602	1832.6112	1832.7103	1832.8112	1832.9103	1832.0113	1832.1102	1832.9101	1832.3407	1832.8204	1834.3311
Spannung Leuchte in V															
Betätigerfarbe / Bedruckung															
Gehäusefarbe		Black	Black	Black	Black	Black	White	Black	Black	Black	Black	Black	Black	Black	
20 (4) A 250 V AC 1E4		•	•	•	•	•	•	•	•	•	•	•	•	•	
16 (4) A 250 V AC 1E4															
10 (8) A 250 V AC 5E4		•	•	•	•	•	•	•	•	•	•	•	•	•	
10 (4) A 250 V AC 1E4															
10 A 12 V DC															
6 (4) A 250 V AC 5E4															
6 (4) A 250 V AC 1E4															
6 (4) A 250 V AC															
4 (2) A 250 V AC 1E4															
30 mA 12 V DC															
16 A 250 V AC 1 HP		•	•	•	•	•	•	•	•	•	•	•	•	•	
16 A 125 V AC 1 HP															
16 A 250 V AC 1/2 HP															
16 A 125 V AC 1/3 HP		•	•	•	•	•	•	•	•	•	•	•	•	•	
16 A 125 V AC 1/4 HP															
6 A 250 V AC 1/2 HP															
6 A 125 V AC 1/4 HP															
6 A 125 - 250 V AC 1/8 HP															
6 A 125 V AC 1/10 HP															
4 A 250 V AC 1/10 HP															
Anschlussart															
Anschlussbeschreibung		6.3	6.3	6.3	6.3	4.8	6.3	6.3	6.3	4.8	6.3	6.3	6.3	6.3	
Kontaktabstand in mm		≥ 3	≥ 3	≥ 3	≥ 3	≥ 3	≥ 3	≥ 3	≥ 3	≥ 3	≥ 3	≥ 3	≥ 3	≥ 3	
Kontaktmaterial		Ag	Ag	Ag	Ag	Ag	Ag	Ag	Ag	Ag	Ag	Ag	Ag	Ag	
EN 60335 Kap. 30 konform „G“			•												
Sonstiges			einpolig belegt		Abdeckrahmen 33.2 lang	tieferliegender Flansch	tieferliegender Flansch	tieferliegender Flansch	tieferliegender Flansch	Staubschutzeinlage	tieferliegender Flansch		tieferliegender Flansch		
Lagervariante		•			•		•			•		•			

WIPPSCHALTER

DRUCKSCHALTER

KIPPSCHALTER

SCHIEBESCHALTER

DREHSCHALTER

FUSSSCHALTER

WERKZEUGSCHALTER

TASTEN

SCHNAPPSCHALTER

MIKRO-SIGNALSCHALTER

SENSOREN

BAUREIHE 1830 - EIN- UND ZWEIPOLIGE WIPPSCHALTER

BIS 20 (4) A 250 V AC

zweipolig		Umschalter (DPDT)															
		1834.3312	1834.1102	1834.1103	1834.3309	1834.3603	1834.6103	1839.1402	1839.1407	1839.1410	1839.1502	1839.1509	1839.1518	1839.1602	1839.2203	1839.3502	1839.3503
Spannung Leuchte in V																	
Betätigerfarbe / Bedruckung																	
Gehäusefarbe																	
20 (4) A 250 V AC 1E4																	
16 (4) A 250 V AC 1E4		●															
10 (8) A 250 V AC 5E4																	
10 (4) A 250 V AC 1E4			●	●	●	●	●										
10 A 12 V DC																	
6 (4) A 250 V AC 5E4			●	●	●	●	●										
6 (4) A 250 V AC 1E4								●	●	●	●	●	●	●	●	●	●
6 (4) A 250 V AC																	
4 (2) A 250 V AC 1E4																	
30 mA 12 V DC																	
16 A 250 V AC 1 HP																	
16 A 125 V AC 1 HP																	
16 A 250 V AC 1/2 HP		●															
16 A 125 V AC 1/3 HP																	
16 A 125 V AC 1/4 HP		●															
6 A 250 V AC 1/2 HP			●	●	●	●	●										
6 A 125 V AC 1/4 HP			●	●	●	●	●										
6 A 125 - 250 V AC 1/8 HP								●	●	●	●	●	●	●	●	●	●
6 A 125 V AC 1/10 HP																	
4 A 250 V AC 1/10 HP																	
Anschlussart																	
Anschlussbeschreibung		6.3	4.8	4.8	6.3	6.3	4.8	4.8	4.8	4.8	4.8	4.8	4.8	4.8	4.8	6.3	6.3
Kontaktabstand in mm		≥ 3	≥ 3	≥ 3	≥ 3	≥ 3	≥ 3	≥ 3	≥ 3	≥ 3	≥ 3	≥ 3	≥ 3	≥ 3	≥ 3	≥ 3	≥ 3
Kontaktmaterial		Ag	Ag	Ag	Ag	Ag	Ag	Ag	Ag	Ag	Ag	Ag	Ag	Ag	Ag	Ag	Ag
EN 60335 Kap. 30 konform „G“					●												
Sonstiges						Abdeckrahmen 33.2 lang	tieferliegender Flansch	Tastfunktion beidseitig	Tastfunktion beidseitig	Tastfunktion beidseitig Staubschutzeinlage			Staubschutzeinlage	Tastfunktion einseitig	Tastfunktion einseitig		
Lagervariante		●	●		●			●	●		●	●				●	

WIPPSCHALTER

DRUCKSCHALTER

KIPPSCHALTER

SCHIEBESCHALTER

DREHSCHALTER

FUSSSCHALTER

WENKZEUGSCHALTER

TASTEN

















SCHNIPPSCHALTER

MIKRO-SIGNALSCHALTER

SENSOREN

BAUREIHE 1830 - EIN- UND ZWEIPOLIGE WIPPSCHALTER

BIS 20 (4) A 250 V AC

zweipolig		Umschalter (DPDT)				Umschalter mit AUS-Stellung in der Mitte (DPDT - Center OFF)		Wechsler (DPDT Momentary)	
		1839.3602	1839.7304	1839.3352	1839.0105	1839.3412	1839.3512	1834.3402	1834.3504
Spannung Leuchte in V									
Betätigerfarbe / Bedruckung									
Gehäusefarbe									
20 (4) A 250 V AC 1E4									
16 (4) A 250 V AC 1E4						●	●		
10 (8) A 250 V AC 5E4									
10 (4) A 250 V AC 1E4									
10 A 12 V DC									
6 (4) A 250 V AC 5E4									
6 (4) A 250 V AC 1E4		●	●						
6 (4) A 250 V AC									
4 (2) A 250 V AC 1E4								●	●
30 mA 12 V DC				●					
16 A 250 V AC 1 HP									
16 A 125 V AC 1 HP									
16 A 250 V AC 1/2 HP						●	●		
16 A 125 V AC 1/3 HP						●	●		
16 A 125 V AC 1/4 HP									
6 A 250 V AC 1/2 HP									
6 A 125 V AC 1/4 HP									
6 A 125 - 250 V AC 1/8 HP		●	●						
6 A 125 V AC 1/10 HP								●	●
4 A 250 V AC 1/10 HP								●	●
Anschlussart									
Anschlussbeschreibung		6.3	6.3	6.3	6.3	6.3	6.3	6.3	6.3
Kontaktabstand in mm		≥ 3	≥ 3	≥ 3	≥ 3	≥ 3	≥ 3	≥ 3	≥ 3
Kontaktmaterial		Ag	Ag	Au	Ag	Ag	Ag	Ag	Ag
EN 60335 Kap. 30 konform „G“									
Sonstiges		Tastfunktion einseitig	Tastfunktion einseitig Stauschutzzeile, tieferliegender Flansch	Abdeckrahmen 33.2 lang	Stauschutzzeile		Tastfunktion beidseitig		einpolig belegt
Lagervariante		●				●	●	●	

WIPPSCHALTER

DRUCKSCHALTER

KIPPSCHALTER

SCHIEBESCHALTER

DREHSCHALTER

FUSSSCHALTER

WERKZEUGSCHALTER

TASTEN

SCHNAPPSCHALTER

MIKRO-SIGNALSCHALTER

SENSOREN

BAUREIHE 1830 - EIN- UND ZWEIPOLIGE WIPPSCHALTER

BIS 20 (4) A 250 V AC

Leuchte	Leuchte				
	1837.1118	1837.2504	1837.3102	1837.8102	1837.8108
					
Spannung Leuchte in V	230	230	230	230	230
Betätigerfarbe / Bedruckung					
Gehäusefarbe					
20 (4) A 250 V AC 1E4					
16 (4) A 250 V AC 1E4					
10 (8) A 250 V AC 5E4					
10 (4) A 250 V AC 1E4					
10 A 12 V DC					
6 (4) A 250 V AC 5E4					
6 (4) A 250 V AC 1E4					
6 (4) A 250 V AC					
4 (2) A 250 V AC 1E4					
30 mA 12 V DC					
16 A 250 V AC 1 HP					
16 A 125 V AC 1 HP					
16 A 250 V AC 1/2 HP					
16 A 125 V AC 1/3 HP					
16 A 125 V AC 1/4 HP					
6 A 250 V AC 1/2 HP					
6 A 125 V AC 1/4 HP					
6 A 125 - 250 V AC 1/8 HP					
6 A 125 V AC 1/10 HP					
4 A 250 V AC 1/10 HP					
Anschlussart					
Anschlussbeschreibung	4.8		6.3	6.3	6.3
Kontaktabstand in mm					
Kontaktmaterial					
EN 60335 Kap. 30 konform „G“					
Sonstiges		tieferliegender Flansch		Baugröße Grundtyp 1835	Baugröße Grundtyp 1835
Lagervariante	●		●	●	●

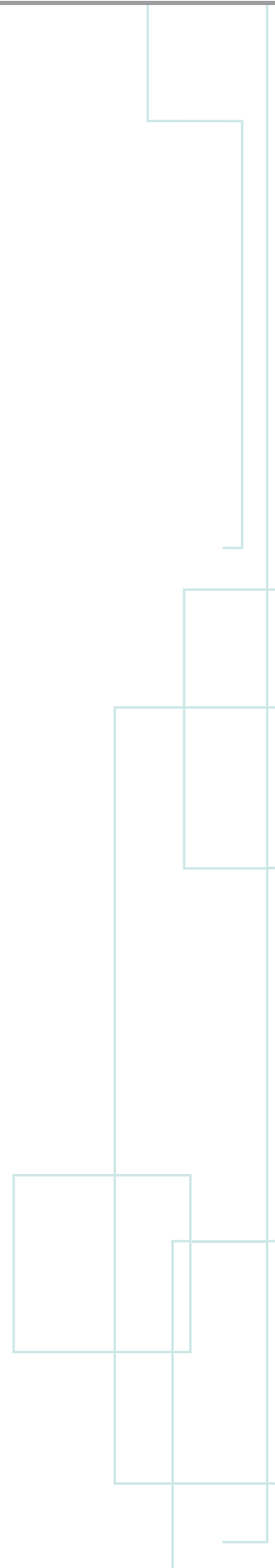

- WIPPSCHALTER
- DRUCKSCHALTER
- KIPPSCHALTER
- SCHIEBESCHALTER
- DREHSCHALTER
- FUSSSCHALTER
- WENZUEGELSCHALTER
- TASTEN
- SCHNAPPSCHALTER
- MIKRO-SIGNALSCHALTER
- SENSOREN

BAUREIHE 1830 - EIN- UND ZWEIPOLIGE WIPPSCHALTER

BIS 20 (4) A 250 V AC



Grundtypen 1830, 1831, 1833
und 1838
einpolig
beleuchtet / unbeleuchtet

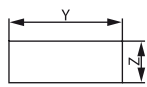

X = Gerätewanddicke

X	Y	Z
0.75 ... 1.25	30 ^{-0.1}	11 ^{+0.1}
1.25 ... 2	30.2 ^{-0.1}	11 ^{+0.1}
2 ... 3	30.6 ^{-0.1}	11 ^{+0.1}

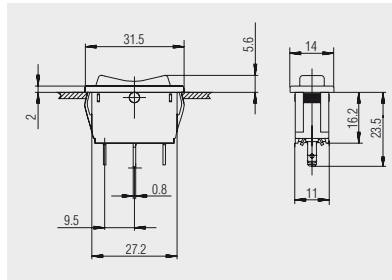

Steckanschluss 2.8
1838.4307

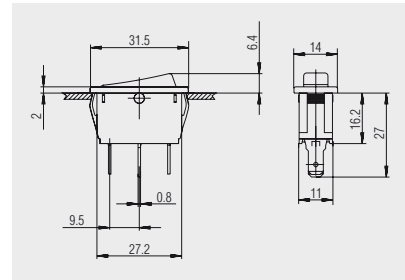

Steckanschluss 4.8
Grundtypen 1830, 1831 und
1833

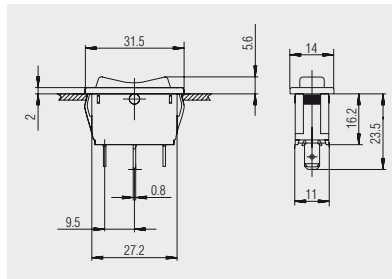

Steckanschluss 4.8
Grundtyp 1838

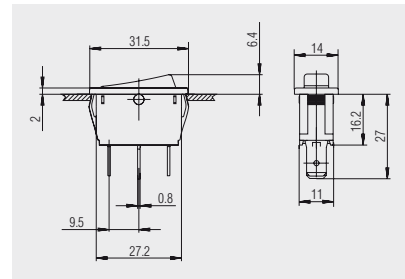

Steckanschluss 6.3
Grundtypen 1831 und 1833

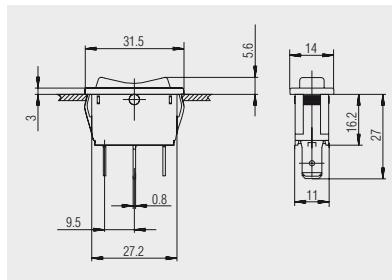

Steckanschluss 6.3
Grundtyp 1838

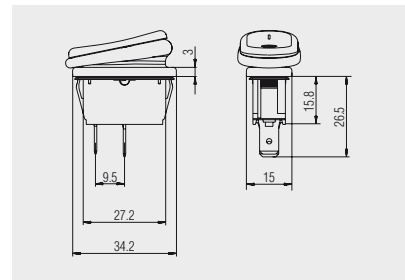

Steckanschluss 6.3
1831.3815

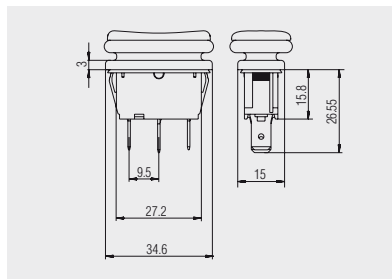

Steckanschluss 6.3
1838.3901

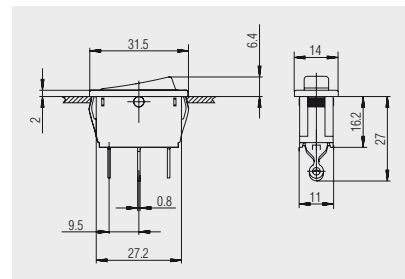

Lötanschluss
Grundtypen 1830 und 1831

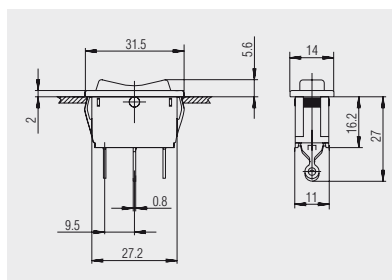

Lötanschluss
Grundtyp 1838

BAUREIHE 1830 - EIN- UND ZWEIPOLIGE WIPPSCHALTER

BIS 20 (4) A 250 V AC



Grundtypen 1832, 1834, 1835
und 1839
zweipolig
beleuchtet / unbeleuchtet

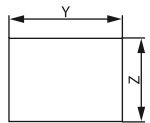

X = Gerätewanddicke

X	Y	Z
0.75 ... 1.25	30 ^{-0.1}	22 ^{+0.2}
1.25 ... 2	30.2 ^{-0.1}	22 ^{+0.2}
2 ... 3	30.6 ^{-0.1}	22 ^{+0.2}

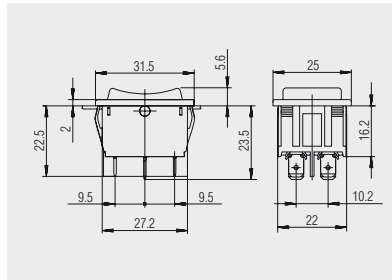

Steckanschluss 4.8
Grundtyp 1839

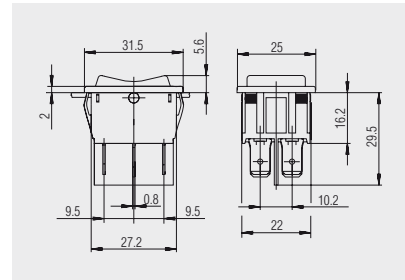

Steckanschluss 6.3
Grundtyp 1839

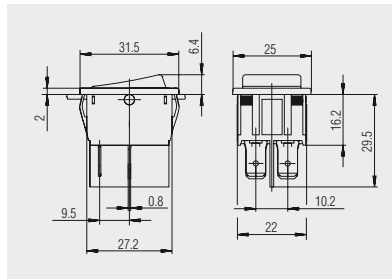

Steckanschluss 6.3 / 4.8
Grundtypen 1832, 1834 und
1835

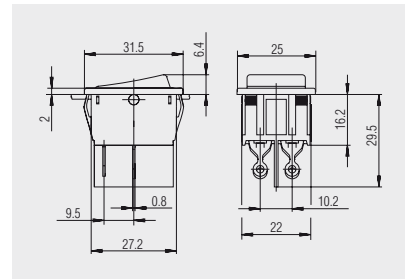

Lötanschluss
Grundtyp 1832

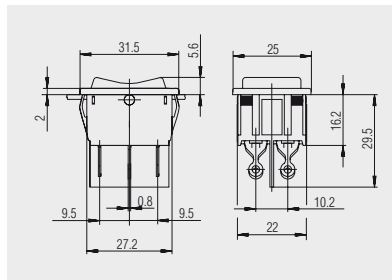

Lötanschluss
Grundtyp 1839

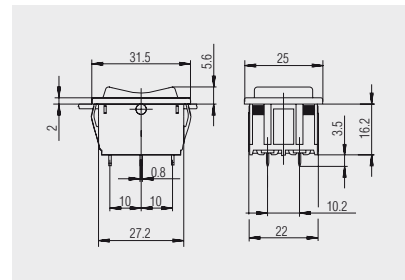

Leiterplattenanschluss
Grundtyp 1839



Grundtypen 1830, 1831, 1833
und 1838
einpilig, tieferliegender Flansch
beleuchtet / unbeleuchtet

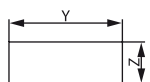

X = Gerätewanddicke

X	Y	Z
0.75 ... 1.25	30 ^{-0.1}	11 ^{+0.1}
1.25 ... 2	30.2 ^{-0.1}	11 ^{+0.1}
2 ... 3	30.6 ^{-0.1}	11 ^{+0.1}

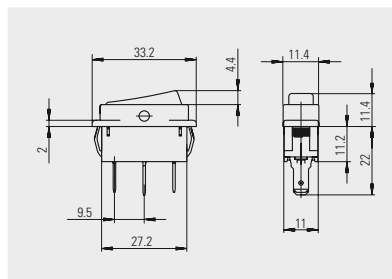

Steckanschluss 4.8
Grundtypen 1830, 1831 und
1833

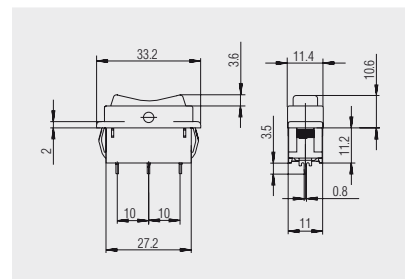

Leiterplattenanschluss
Grundtyp 1838

WIPPSCHALTER

DRUCKSCHALTER

KIPPSCHALTER

SCHIEBESCHALTER

DREHSCHALTER

FUSSSCHALTER

WENKZEUGSCHALTER

TASTEN

SCHNIPPSCHALTER

MIKRO-SIGNALSCHALTER

SENSOREN

BAUREIHE 1830 - EIN- UND ZWEIPOLIGE WIPPSCHALTER

BIS 20 (4) A 250 V AC



Grundtypen 1832, 1834, 1835
und 1839
zweipolig, tieferliegender Flansch
beleuchtet / unbeleuchtet

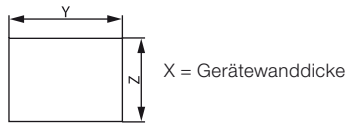

X	Y	Z
0.75 ... 1.25	30 ^{-0.1}	22 ^{+0.2}
1.25 ... 2	30.2 ^{-0.1}	22 ^{+0.2}
2 ... 3	30.6 ^{-0.1}	22 ^{+0.2}

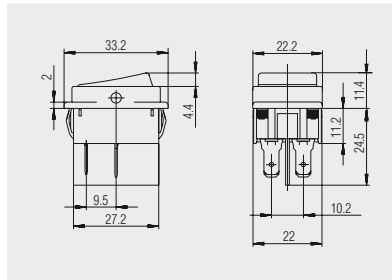

Steckanschluss 4.8
Grundtypen 1832 und 1834

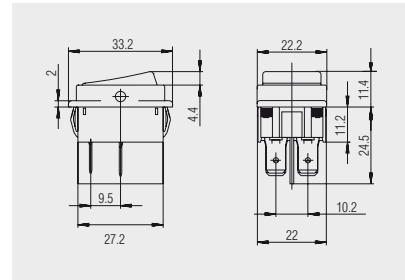

Steckanschluss 6.3
Grundtyp 1832

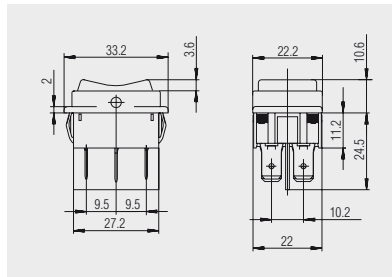

Steckanschluss 6.3
Grundtyp 1839

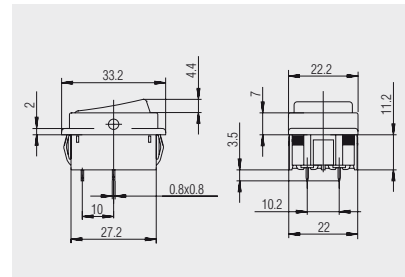

Leiterplattenanschluss
Grundtypen 1832 und 1835

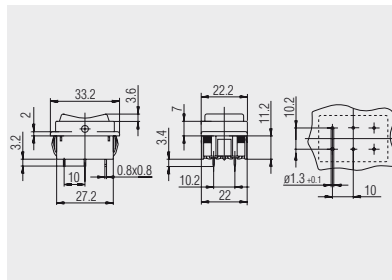

Leiterplattenanschluss
Grundtyp 1839

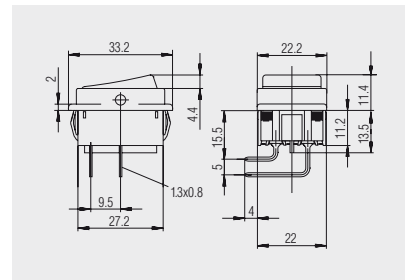

Leiterplattenanschluss
abgewinkelt, Grundtypen
1832 und 1835



Grundtyp 1837
Leuchte
ein- und zweipolig

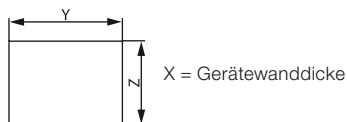

X	Y	Z
0.75 ... 1.25	30 ^{-0.1}	22 ^{+0.1}
1.25 ... 2	30.2 ^{-0.1}	22 ^{+0.1}
2 ... 3	30.6 ^{-0.1}	22 ^{+0.1}

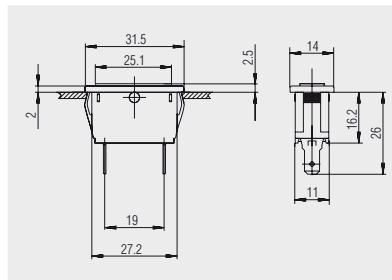

Steckanschluss 4.8
einpolige Baugröße

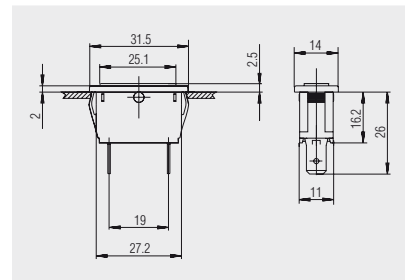

Steckanschluss 6.3
einpolige Baugröße

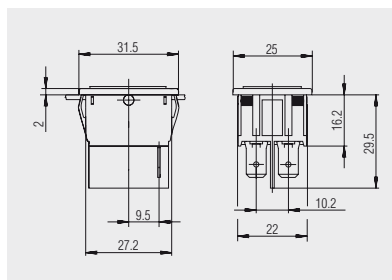

Steckanschluss 6.3
zweipolige Baugröße

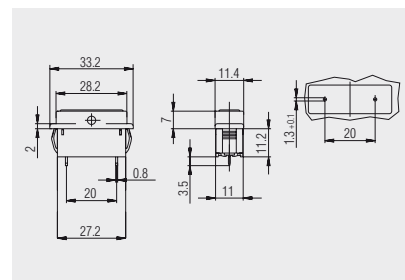

Leiterplattenanschluss, tieferliegender Flansch, 1837.2504

WIPPSCHALTER

DRUCKSCHALTER

KIPPSCHALTER

SCHIEBESCHALTER

DREHSCHALTER

FUSSSCHALTER

WERKZEUGSCHALTER

TASTEN

SCHNAPPSCHALTER

MIKRO-SIGNALSCHALTER

SENSOREN

BAUREIHE 1830 - EIN- UND ZWEIPOLIGE WIPPSCHALTER

BIS 20 (4) A 250 V AC



Schutzkappe
203.731.011

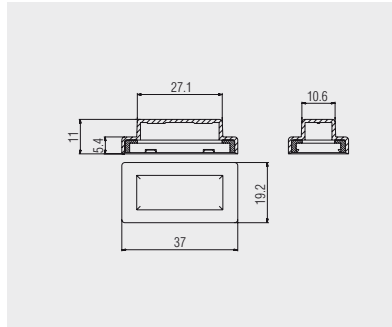

Transparente PVC-Schutzkappe für einpolige Schalter der Grundtypen 1830, 1831, 1833 und 1838. Dient als Staub- und Wasserschutz der Betätigungsseite.



Schutzkappe
203.201.011

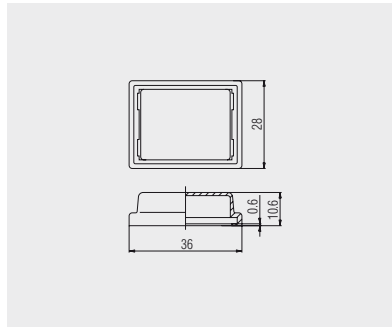

Transparente PVC-Schutzkappe für zweipolige Schalter der Grundtypen 1832, 1834, 1835 und 1839 mit Rahmenlänge 33.2 mm. Dient als Staub- und Wasserschutz der Betätigungsseite.



Blindkappe
203.145.051

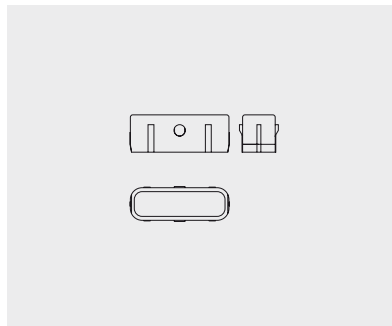

Blindkappe für einpolige Baugröße Grundtyp 1830, 1831, 1833, 1837 und 1838 aus PA schwarz



Blindkappe
203.146.051

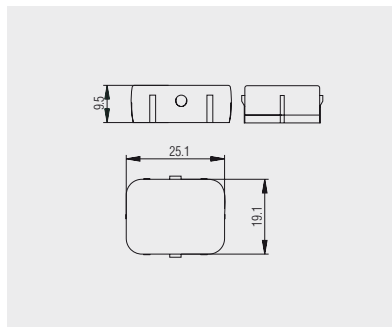

Blindkappe für zweipolige Baugröße Grundtyp 1832, 1834, 1835, 1837 und 1839 aus PA schwarz

WIPPSCHALTER

DRUCKSCHALTER

KIPPSCHALTER

SCHIEBESCHALTER

DREHSCHALTER

FUSSSCHALTER

WERNZEUGSCHALTER

TASTEN

SCHNIPPSCHALTER

MIKRO-SIGNALSCHALTER

SENSOREN