



DAS PRODUKT

Der Name KOMBIKNÖPFE steht für eine äußerst zweckmäßige Drehknopfreihe mit zuverlässigem Spannzangensystem. Als RUND-, FLÜGEL- und KNEBELKNÖPFE mit großem Zubehörprogramm bieten sie vielfältige Einsatzmöglichkeiten.

ANWENDUNGEN

Vielfach bewährt für elektromechanische Drehpotentiometer mit runden Wellenenden nach DIN 41 591, z.B. im Bereich Messen – Steuern – Regeln.

IHRE VORTEILE

Bewährtes Spannzangensystem: Bequeme Knopfmontage von vorn und leichte Justierung (mit Justierschlüssel, siehe Zubehör Seite 18). Sicherer Sitz der Knöpfe auf der Achse. Die Größen 10 und 13 haben Sackbohrung und Schraubenbefestigung. Ab Knopfgröße 23 durchgehende ① Achsbohrung (Größen 16 + 20 abgestuft ②, ausgenommen 4 mm-Achsbohrung).

Rund-, Flügel- und Knebelknöpfe mit einheitlichem Design und matter Oberfläche.

Reichhaltiges, funktionelles Zubehör von farbigen Deckeln bis zu glasklaren Skalenscheiben. Einfaches Zusammenzustecken.

Wir fertigen unser Kombiknopfprogramm unter Berücksichtigung von Mindestlosgrößen auch in Sonderfarben. Nennen Sie uns bitte Ihre Wünsche und Bedarfsmengen.

MATERIAL

Kombiknöpfe, Deckel, Pfeilscheiben, Scheiben und Mutterabdeckung: ABS (UL 94 HB). Skalenscheiben: Polycarbonat. Stator: Al-Blech 0,5 mm mit Selbstklebefolie. Siehe Kunststoffeigenschaften Seite 29.

Kombiknöpfe, Scheibe, Mutterabdeckung



Schwarz, RAL 9005 
Staubgrau, RAL 7037 

Deckel

(größen-/ typenabhängig)

Schwarz, RAL 9005 
Rot, RAL F12/0-10 
Gelb, RAL F12/0-1 
Grün, RAL F12/0-43 
Blau, RAL 5012 
Kieselgrau, RAL 7032 
Staubgrau, RAL 7037 

Pfeilscheibe

Schwarz, RAL 9005 
Rot, RAL F12/0-10 
Staubgrau, RAL 7037 

Skalenscheibe

Glasklar, glänzend 
mit/ohne Beschriftung

Stator

Aluminium, 
Markierung schwarz

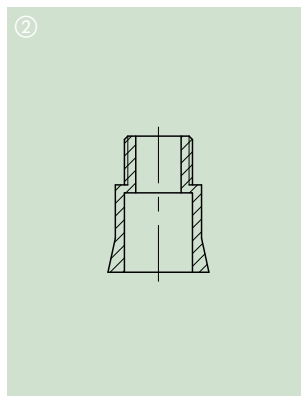
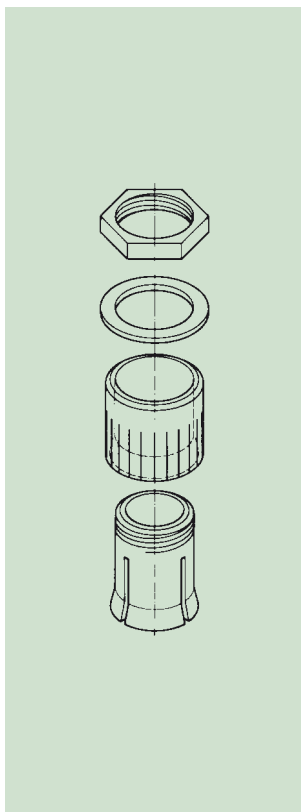

KNOPFARTEN

Knopf Ø	Drehmoment (Nm)		RUNDKNOPF		FLÜGELKNOPF		KNEBELKNOPF	
	Montage	Funktion	Achsbohrung		Achsbohrung		Achsbohrung	
9	0,4	0,4	4 mm		-	-	-	-
10	0,4	0,4	3 mm		-	-	-	-
	0,4	0,4	4 mm		-	-	-	-
	0,4	0,4	1/8"		-	-	-	-
13,5	0,5	0,5	4 mm		-		-	-
	0,7	0,6	6 mm		6 mm		-	-
16	0,5	0,5	-		-		3 mm	
	0,6	0,5	4 mm		-		4 mm	
	0,8	0,7	6 mm		6 mm		-	
	0,8	0,7	1/4"		-		-	
20	0,8	0,7	4 mm		-	-	-	-
	1,0	0,9	6 mm		-	-	-	
	1,0	0,9	1/4"		-	-	-	
23	1,0	0,8	4 mm		-	-	4 mm	
	1,2	1,0	6 mm		-	6 mm		
	1,2	1,0	1/4"		-	-		
31	1,8	1,6	6 mm		-	-	6 mm	
	1,8	1,6	1/4"		-	-		
40	2,5	1,6	6 mm		-	-	6 mm	
	2,8	1,8	8 mm		-	-		
50	3,0	1,8	6 mm		-	-	-	-
	3,5	2,0	8 mm		-	-	-	-

KOMBIKNÖPFE

RUNDKNOPF
FLÜGELKNOPF
KNEBELKNOPF
DECKEL

...100 = Markierung weiß, ansonsten schwarz

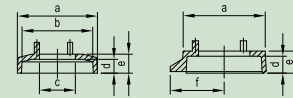

Größe ø	Knopfform	Achsbohrung D	[Color swatches]				ohne Markierung	mit Markierung	
9	 RUND- KNOPF	4 mm, abgesetzt		A 26 09 040			a = 8,0 b = 6,5 c = 2,6	<ul style="list-style-type: none"> A 41 10 000 A 41 10 002 A 41 10 004 A 41 10 005 A 41 10 006 A 41 10 007 A 41 10 008 	A 41 10 100 A 41 10 102 A 41 10 104 A 41 10 105 A 41 10 106
10	 RUND- KNOPF	3 mm, abgesetzt	A 25 10 030	A 26 10 030	A 25 10 038	A 26 10 038	a = 11,2 b = 9,2 c = 3,0	<ul style="list-style-type: none"> A 41 13 000 A 41 13 002 A 41 13 004 A 41 13 005 A 41 13 006 A 41 13 007 A 41 13 008 	A 41 13 100 A 41 13 102 A 41 13 104 A 41 13 105 A 41 13 106 A 41 13 107 A 41 13 108
		1/8", abgesetzt	A 25 10 320	A 26 10 320					
		4 mm, abgesetzt	A 25 10 040	A 26 10 040	A 25 10 048	A 26 10 048			
13,5	 RUND- KNOPF	4 mm, abgesetzt	A 25 13 040	A 26 13 040	A 25 13 048	A 26 13 048	a = 13,5 b = 11,2 c = 4,0	<ul style="list-style-type: none"> A 41 16 000 A 41 16 002 A 41 16 004 A 41 16 005 A 41 16 006 A 41 16 007 A 41 16 008 	A 41 16 100 A 41 16 102 A 41 16 106
		6 mm, abgesetzt	A 25 13 060	A 26 13 060	A 25 13 068	A 26 13 068			
	 FLÜGEL- KNOPF	6 mm, abgesetzt		A 28 13 060				A 41 16 108	
16	 RUND- KNOPF	4 mm, durchgehend	A 25 16 040	A 26 16 040			a = 14,0 b = 1,2 c = 4,0	<ul style="list-style-type: none"> A 50 16 000 A 50 16 100 	A 50 16 100 A 50 16 108
		6 mm, abgesetzt	A 25 16 060	A 26 16 060	A 25 16 068	A 26 16 068			
		1/4", abgesetzt	A 25 16 630	A 26 16 630	A 25 16 638				
	 FLÜGEL- KNOPF	6 mm, abgesetzt		A 28 16 060					
	 KNEBEL- KNOPF	3 mm, abgesetzt		A 24 16 030					
		4 mm, abgesetzt	A 23 16 040	A 24 16 040		A 24 16 048			

PFEILSCHEIBE
SCHEIBE
SKALENSCHEIBE
STATOR
MUTTERABDECKUNG

...010 = Markierung weiß

 ...0 = Symbole schwarz
 ...9 = Symbole silber

 Markierung
 schwarz

 ...010 = Markierung weiß
 ...018 = Markierung schwarz

 a = 7,0
 b = 10,1
 c = 7,0

A 42 10 000



A 42 10 002



A 42 10 008

 a = 20,0
 b = 7,0
 c = 1,5

A 44 10 060

 (nur für
 Größe 10)

 a = 15,5
 b = 14,0
 c = 7,0
 d = 2,9
 e = 3,7

A 75 10 000



A 75 10 010

A 75 10 018

 (nur für
 Größe 10)

 a = 9,0
 b = 13,6
 c = 8,0

A 42 13 000



A 42 13 002



A 42 13 008

 a = 26,0
 b = 8,0
 c = 1,5

A 44 13 010



A 44 13 020



A 44 13 049



A 44 13 060

 a = 17,5
 b = 15,7
 c = 9,0
 d = 3,2
 e = 4,3

A 75 13 000



A 75 13 010

A 75 13 018

 a = 10,5
 b = 16,3
 c = 10,0

A 42 16 000



A 42 16 002



A 42 16 008

 a = 23,0
 b = 10,0
 c = 1,3

A 73 16 000

A 73 16 010

 a = 31,0
 b = 14,5
 c = 10,0
 d = 2,5
 e = 1,7

A 44 16 001



A 44 16 010



A 44 16 020



A 44 16 060

 (ø 16
 mit ange-
 spritzter
 Mutter-
 abdek-
 kung)

 a=16,0
 b=10,1
 c=15,5

A 60 16 019

 a = 19,3
 b = 17,6
 c = 10,0
 d = 3,3
 e = 4,3

A 75 16 000



A 75 16 010

A 75 16 018



A 76 16 000



A 76 16 008

 a = 16,4
 b = 14,6
 c = 10,0
 d = 3,3
 e = 4,3
 f = 10,2

 a = 16,0
 b = 14,8
 c = 8,3
 d = 3,3
 e = 4,3

A 51 16 000

RUNDKNOPF
FLÜGELKNOPF
KNEBELKNOPF
DECKEL



...100 = Markierung weiß, ansonsten schwarz

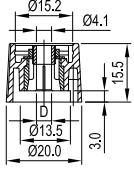
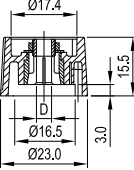
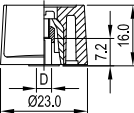
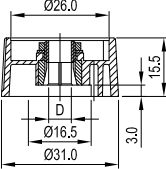
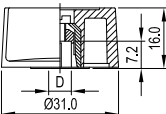

Größe Ø	Knopfform	Achsbohrung D	Achsbohrung				a	b	c	Markierung		
			flügel	flügel	knopf	knopf				ohne	mit	
20	RUND-KNOPF 	4 mm, durchgehend	A 25 20 040	A 26 20 040			17,5	15,2	5,5	●	A 41 20 000	A 41 20 100
		6 mm, abgesetzt	A 25 20 060	A 26 20 060	A 25 20 068	A 26 20 068				●	A 41 20 002	A 41 20 102
		1/4", abgesetzt	A 25 20 630							●	A 41 20 004	A 41 20 104
23	RUND-KNOPF 	4 mm, durchgehend	A 25 23 040	A 26 23 040			20,4	17,4	6,5	●	A 41 23 000	A 41 23 100
		6 mm, durchgehend	A 25 23 060	A 26 23 060	A 25 23 068	A 26 23 068				●	A 41 23 002	A 41 23 102
		1/4", durchgehend	A 25 23 630		A 25 23 638					●	A 41 23 004	A 41 23 105
	KNEBEL-KNOPF 	4 mm, abgesetzt		A 24 23 040		20,9	1,2	6,5	●	A 50 23 000	A 50 23 100	
6 mm, abgesetzt			A 24 23 060		A 24 23 068				●	A 50 23 008	A 50 23 108	
31	RUND-KNOPF 	6 mm, durchgehend	A 25 31 060	A 26 31 060	A 25 31 068	A 26 31 068	28,4	26,0	9,0	●	A 41 31 000	A 41 31 100
		1/4", durchgehend	A 25 31 630							●	A 41 31 002	A 41 31 102
										●	A 41 31 005	
	KNEBEL-KNOPF 	6 mm, abgesetzt		A 24 31 060		29,0	1,4	9,5	●	A 50 31 000	A 50 31 100	
					A 24 31 068				●	A 50 31 008	A 50 31 107	
									●		A 50 31 108	

PFEILSCHEIBE
SCHEIBE
SKALENSCHEIBE
STATOR
MUTTERABDECKUNG

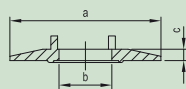
...010 = Markierung weiß

 ...0 = Symbole schwarz
 ...9 = Symbole silber

 Markierung
 schwarz

 a = 13,0
 b = 20,0
 c = 12,0

A 42 20 000



A 42 20 002



A 42 20 008

 a = 36,0
 b = 12,0
 c = 1,5

A 44 20 001



A 44 20 010



A 44 20 060

 a=20,0
 b=10,1
 c=18,0

A 60 20 019

 a = 14,3
 b = 23,0
 c = 16,5

A 42 23 000



A 42 23 002



A 42 23 008

 a = 31,0
 b = 16,5
 c = 1,3

A 73 23 010

 a = 40,0
 b = 16,3
 c = 1,3

A 44 23 010



A 44 23 020



A 44 23 039



A 44 23 060

 a=23,0
 b=10,2
 c=20,0

A 60 23 019

 a = 23,3
 b = 20,0
 c = 13,7
 d = 3,3
 e = 4,3

A 51 23 000



A 51 23 008

 a = 19,5
 b = 31,0
 c = 16,5

A 42 31 000



A 42 31 002



A 42 31 008

 a = 40,0
 b = 16,5
 c = 1,6

A 73 31 000

A 73 31 010

 a = 49,9
 b = 16,5
 c = 1,5

A 44 31 010



A 44 31 060

 a = 31,1
 b = 28,0
 c = 15,5
 d = 3,3
 e = 4,8

A 51 31 000









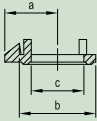
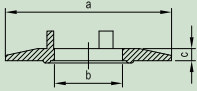
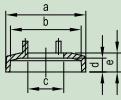

A 51 31 008

RUNDKNOPF
KNEBELKNOPF
DECKEL

...100 = Markierung weiß, ansonsten schwarz



Größe Ø	Knopfform	Achsb Bohrung D	Cover Profiles				a	b	c	Markierung	
			1	2	3	4				ohne Markierung	mit Markierung
40	RUND-KNOPF 	6 mm, durchgehend	A 25 40 060	A 26 40 060	A 25 40 068	A 26 40 068	37,4	34,4	12,5	● A 41 40 000	A 41 40 100
		8 mm, durchgehend	A 25 40 080							● A 41 40 002	
40	KNEBEL-KNOPF 	6 mm, abgesetzt		A 24 40 060		A 24 40 068	37,9	1,6	13,0	● A 50 40 000	A 50 40 100
						● A 50 40 008				A 50 40 108	
50	RUND-KNOPF 	6 mm, durchgehend	A 25 50 060	A 26 50 060	A 25 50 068		47,4	44,4	14,5	● A 41 50 000	A 41 50 100
						● A 41 50 008				A 41 50 107	

PFEILSCHEIBE		SCHEIBE		SKALENSCHEIBE		STATOR		MUTTERABDECKUNG	
		<p>...010 = Markierung weiß</p> 							
		 						 	
<p>a = 24,5 b = 40,0 c = 25,0</p>  	<p>A 42 40 000</p> <hr/> <p>A 42 40 008</p>		<p>a = 50,1 b = 24,0 c = 1,8</p> 	<p>A 73 40 010</p>					
								<p>a = 40,3 b = 36,8 c = 20,0 d = 3,1 e = 4,6</p> 	<p>A 51 40 000</p>

FÜR RUND- / FLÜGEL- / KNEBELKNÖPFE / COM-KNOBS

Bestell-Nummer	Artikel	Ausführung / Verwendung	Maße in mm	Abbildung
A 61 16 010	Feststeller mit Stator	Nur für Rund- und Flügelknöpfe Größe 16 mit Skalenscheibe. Glasklar, Markierung schwarz.		
A 61 00 000	Feststeller	Universell für Rund- und Flügelknöpfe sowie COM-KNOBS mit Skalenscheibe verwendbar.		
	Justierschlüssel	Für genaues Einstellen von Kombiknöpfen (Rundknöpfe) mit Markierungsstrich, Skalen- und Pfeilscheiben. Problemlose Knopfmontage.		
	Rundmutter	Zur Befestigung der Potentiometer an Blenden. Passt unter Knopf und Mutterabdeckung (Rundknöpfe / Flügelknöpfe / Knebelknöpfe / COM-KNOBS \varnothing 10 / 13,5 / 16 / 20 / 23 / 31 / 40 / 50).		
	Steckschlüssel	Zum Anziehen der Rundmutter.		
	Verdrehungsschutz	Ermöglicht verdrehungssichere Knopfmontage auf Profilachsen 6 / 4,6 mm. Geeignet für Rund- und Flügelknöpfe \varnothing 20 bis 50 mit 6 mm Achsbohrung (nicht für COM-KNOBS passend).		

Rundknöpfe \varnothing	D ₁	D ₂	D ₃
A 64 02 005	10	13,5	16
A 64 03 005	20	23	31

G	\varnothing
A 62 07 009	M 7 x 0,75 13,5
A 62 10 009	M 10 x 0,75 12,5
A 62 95 009	3/8" - 32G 12,5