



## DAS PRODUKT

Der Name KOMBIKNÖPFE steht für eine äußerst zweckmäßige Drehknopfreihe mit zuverlässigem Spannzangensystem. Als RUND-, FLÜGEL- und KNEBELKNÖPFE mit großem Zubehörprogramm bieten sie vielfältige Einsatzmöglichkeiten.

## ANWENDUNGEN

Vielfach bewährt für elektromechanische Drehpotentiometer mit runden Wellenenden nach DIN 41 591, z.B. im Bereich Messen – Steuern – Regeln.

## IHRE VORTEILE

Bewährtes Spannzangensystem: Bequeme Knopfmontage von vorn und leichte Justierung (mit Justierschlüssel, siehe Zubehör Seite 18). Sicherer Sitz der Knöpfe auf der Achse. Die Größen 10 und 13 haben Sackbohrung und Schraubenbefestigung. Ab Knopfgröße 23 durchgehende ① Achsbohrung (Größen 16 + 20 abgestuft ②, ausgenommen 4 mm-Achsbohrung).

Rund-, Flügel- und Knebelknöpfe mit einheitlichem Design und matter Oberfläche.



Reichhaltiges, funktionelles Zubehör von farbigen Deckeln bis zu glasklaren Skalenscheiben. Einfaches Zusammenzustecken.

Wir fertigen unser Kombiknopfprogramm unter Berücksichtigung von Mindestlosgrößen auch in Sonderfarben. Nennen Sie uns bitte Ihre Wünsche und Bedarfsmengen.

## MATERIAL







Kombiknöpfe, Deckel, Pfeilscheiben, Scheiben und Mutterabdeckung: ABS (UL 94 HB). Skalenscheiben: Polycarbonat. Stator: Al-Blech 0,5 mm mit Selbstklebefolie. Siehe Kunststoffeigenschaften Seite 29.

### Kombiknöpfe, Scheibe, Mutterabdeckung



Schwarz, RAL 9005   
Staubgrau, RAL 7037 

### Deckel

(größen-/ typenabhängig)

Schwarz, RAL 9005   
Rot, RAL F12/0-10   
Gelb, RAL F12/0-1   
Grün, RAL F12/0-43   
Blau, RAL 5012   
Kieselgrau, RAL 7032   
Staubgrau, RAL 7037 

### Pfeilscheibe

Schwarz, RAL 9005   
Rot, RAL F12/0-10   
Staubgrau, RAL 7037 

### Skalenscheibe

Glasklar, glänzend   
mit/ohne Beschriftung

### Stator

Aluminium,   
Markierung schwarz

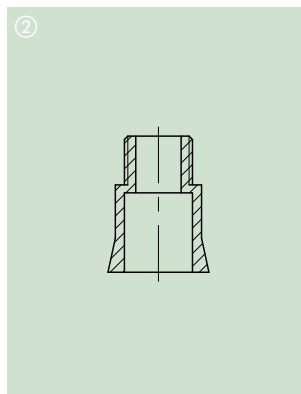
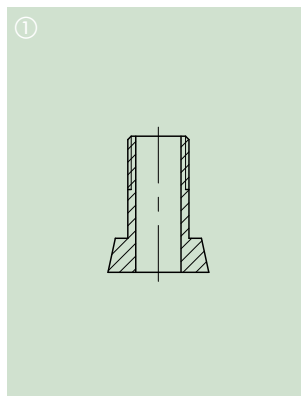
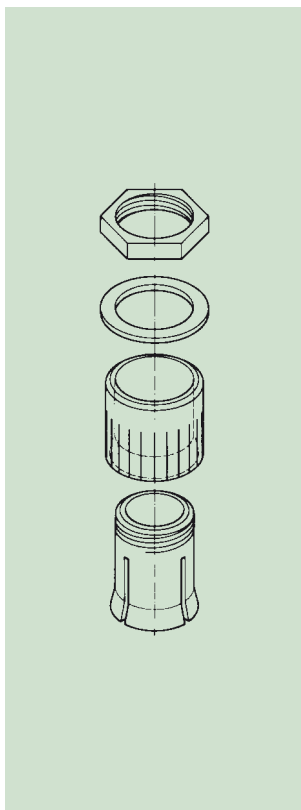

## KNOPFARTEN

Knopf Ø	Drehmoment (Nm)		RUNDKNOPF		FLÜGELKNOPF		KNEBELKNOPF	
	Montage	Funktion	Achsbohrung		Achsbohrung		Achsbohrung	
9	0,4	0,4	4 mm		-	-	-	-
10	0,4	0,4	3 mm		-	-	-	-
	0,4	0,4	4 mm		-	-	-	-
	0,4	0,4	1/8"		-	-	-	-
13,5	0,5	0,5	4 mm		-		-	-
	0,7	0,6	6 mm		6 mm		-	-
16	0,5	0,5	-		-		3 mm	
	0,6	0,5	4 mm		-		4 mm	
	0,8	0,7	6 mm		6 mm		-	
	0,8	0,7	1/4"		-		-	
20	0,8	0,7	4 mm		-	-	-	-
	1,0	0,9	6 mm		-	-	-	
	1,0	0,9	1/4"		-	-	-	
23	1,0	0,8	4 mm		-	-	4 mm	
	1,2	1,0	6 mm		-	6 mm		
	1,2	1,0	1/4"		-	-		
31	1,8	1,6	6 mm		-	-	6 mm	
	1,8	1,6	1/4"		-	-		
40	2,5	1,6	6 mm		-	-	6 mm	
	2,8	1,8	8 mm		-	-		
50	3,0	1,8	6 mm		-	-	-	-
	3,5	2,0	8 mm		-	-	-	-

KOMBIKNÖPFE

**RUNDKNOPF**
**FLÜGELKNOPF**
**KNEBELKNOPF**
**DECKEL**

...100 = Markierung weiß, ansonsten schwarz

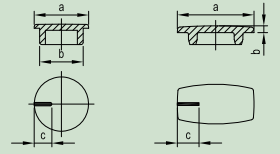

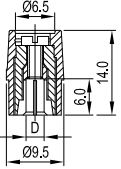
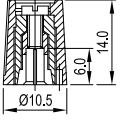
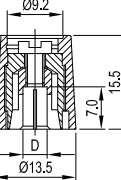
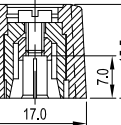
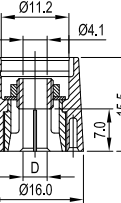
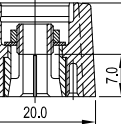
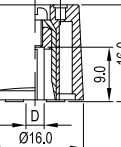
Größe ø	Knopfform	Achsbohrung D	[Color swatches]				ohne Markierung	mit Markierung		
9	 <b>RUND- KNOPF</b>	4 mm, abgesetzt		A 26 09 040			a = 8,0 b = 6,5 c = 2,6	<ul style="list-style-type: none"> <li><span style="display: inline-block; width: 10px; height: 10px; background-color: black; border-radius: 50%;"></span> A 41 10 000</li> <li><span style="display: inline-block; width: 10px; height: 10px; background-color: red; border-radius: 50%;"></span> A 41 10 002</li> <li><span style="display: inline-block; width: 10px; height: 10px; background-color: yellow; border-radius: 50%;"></span> A 41 10 004</li> <li><span style="display: inline-block; width: 10px; height: 10px; background-color: green; border-radius: 50%;"></span> A 41 10 005</li> <li><span style="display: inline-block; width: 10px; height: 10px; background-color: blue; border-radius: 50%;"></span> A 41 10 006</li> <li><span style="display: inline-block; width: 10px; height: 10px; background-color: grey; border-radius: 50%;"></span> A 41 10 007</li> <li><span style="display: inline-block; width: 10px; height: 10px; background-color: lightgrey; border-radius: 50%;"></span> A 41 10 008</li> </ul>	<ul style="list-style-type: none"> <li>A 41 10 100</li> <li>A 41 10 102</li> <li>A 41 10 104</li> <li>A 41 10 105</li> <li>A 41 10 106</li> <li>A 41 10 108</li> </ul>	
10	 <b>RUND- KNOPF</b>	3 mm, abgesetzt	A 25 10 030	A 26 10 030	A 25 10 038	A 26 10 038	a = 11,2 b = 9,2 c = 3,0	<ul style="list-style-type: none"> <li><span style="display: inline-block; width: 10px; height: 10px; background-color: black; border-radius: 50%;"></span> A 41 13 000</li> <li><span style="display: inline-block; width: 10px; height: 10px; background-color: red; border-radius: 50%;"></span> A 41 13 002</li> <li><span style="display: inline-block; width: 10px; height: 10px; background-color: yellow; border-radius: 50%;"></span> A 41 13 004</li> <li><span style="display: inline-block; width: 10px; height: 10px; background-color: green; border-radius: 50%;"></span> A 41 13 005</li> <li><span style="display: inline-block; width: 10px; height: 10px; background-color: blue; border-radius: 50%;"></span> A 41 13 006</li> <li><span style="display: inline-block; width: 10px; height: 10px; background-color: grey; border-radius: 50%;"></span> A 41 13 007</li> <li><span style="display: inline-block; width: 10px; height: 10px; background-color: lightgrey; border-radius: 50%;"></span> A 41 13 008</li> </ul>	<ul style="list-style-type: none"> <li>A 41 13 100</li> <li>A 41 13 102</li> <li>A 41 13 104</li> <li>A 41 13 105</li> <li>A 41 13 106</li> <li>A 41 13 107</li> <li>A 41 13 108</li> </ul>	
		1/8", abgesetzt	A 25 10 320	A 26 10 320						
		4 mm, abgesetzt	A 25 10 040	A 26 10 040	A 25 10 048	A 26 10 048				
13,5	 <b>RUND- KNOPF</b>	4 mm, abgesetzt	A 25 13 040	A 26 13 040	A 25 13 048	A 26 13 048	a = 13,5 b = 11,2 c = 4,0	<ul style="list-style-type: none"> <li><span style="display: inline-block; width: 10px; height: 10px; background-color: black; border-radius: 50%;"></span> A 41 16 000</li> <li><span style="display: inline-block; width: 10px; height: 10px; background-color: red; border-radius: 50%;"></span> A 41 16 002</li> <li><span style="display: inline-block; width: 10px; height: 10px; background-color: yellow; border-radius: 50%;"></span> A 41 16 004</li> <li><span style="display: inline-block; width: 10px; height: 10px; background-color: green; border-radius: 50%;"></span> A 41 16 005</li> <li><span style="display: inline-block; width: 10px; height: 10px; background-color: blue; border-radius: 50%;"></span> A 41 16 006</li> <li><span style="display: inline-block; width: 10px; height: 10px; background-color: grey; border-radius: 50%;"></span> A 41 16 007</li> <li><span style="display: inline-block; width: 10px; height: 10px; background-color: lightgrey; border-radius: 50%;"></span> A 41 16 008</li> </ul>	<ul style="list-style-type: none"> <li>A 41 16 100</li> <li>A 41 16 102</li> <li>A 41 16 106</li> <li>A 41 16 107</li> <li>A 41 16 108</li> </ul>	
		6 mm, abgesetzt	A 25 13 060	A 26 13 060	A 25 13 068	A 26 13 068				
	 <b>FLÜGEL- KNOPF</b>	6 mm, abgesetzt		A 28 13 060						
16	 <b>RUND- KNOPF</b>	4 mm, durchgehend	A 25 16 040	A 26 16 040			a = 14,0 b = 1,2 c = 4,0	<ul style="list-style-type: none"> <li><span style="display: inline-block; width: 10px; height: 10px; background-color: black; border-radius: 50%;"></span> A 50 16 000</li> <li><span style="display: inline-block; width: 10px; height: 10px; background-color: red; border-radius: 50%;"></span> A 50 16 100</li> <li><span style="display: inline-block; width: 10px; height: 10px; background-color: yellow; border-radius: 50%;"></span> A 50 16 108</li> </ul>	<ul style="list-style-type: none"> <li>A 50 16 100</li> <li>A 50 16 108</li> </ul>	
		6 mm, abgesetzt	A 25 16 060	A 26 16 060	A 25 16 068	A 26 16 068				
		1/4", abgesetzt	A 25 16 630	A 26 16 630	A 25 16 638					
	 <b>FLÜGEL- KNOPF</b>	6 mm, abgesetzt		A 28 16 060						
	 <b>KNEBEL- KNOPF</b>	3 mm, abgesetzt		A 24 16 030						
		4 mm, abgesetzt	A 23 16 040	A 24 16 040		A 24 16 048				

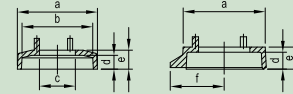
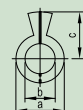
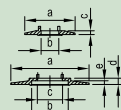
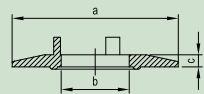
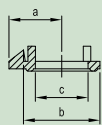
**PFEILSCHEIBE**
**SCHEIBE**
**SKALENSCHEIBE**
**STATOR**
**MUTTERABDECKUNG**

...010 = Markierung weiß

 ...0 = Symbole schwarz  
 ...9 = Symbole silber

 Markierung  
 schwarz

 ...010 = Markierung weiß  
 ...018 = Markierung schwarz

 a = 7,0  
 b = 10,1  
 c = 7,0

A 42 10 000



A 42 10 002



A 42 10 008

 a = 20,0  
 b = 7,0  
 c = 1,5

A 44 10 060

 (nur für  
 Größe 10)

 a = 15,5  
 b = 14,0  
 c = 7,0  
 d = 2,9  
 e = 3,7

A 75 10 000



A 75 10 010

A 75 10 018

 (nur für  
 Größe 10)

 a = 9,0  
 b = 13,6  
 c = 8,0

A 42 13 000



A 42 13 002



A 42 13 008

 a = 26,0  
 b = 8,0  
 c = 1,5

A 44 13 010



A 44 13 020



A 44 13 049



A 44 13 060

 a = 17,5  
 b = 15,7  
 c = 9,0  
 d = 3,2  
 e = 4,3

A 75 13 000



A 75 13 010

A 75 13 018

 a = 10,5  
 b = 16,3  
 c = 10,0

A 42 16 000



A 42 16 002



A 42 16 008

 a = 23,0  
 b = 10,0  
 c = 1,3

A 73 16 000

A 73 16 010

 a = 31,0  
 b = 14,5  
 c = 10,0  
 d = 2,5  
 e = 1,7

A 44 16 001



A 44 16 010



A 44 16 020



A 44 16 060

 (ø 16  
 mit ange-  
 spritzter  
 Mutter-  
 abdek-  
 kung)

 a=16,0  
 b=10,1  
 c=15,5

A 60 16 019

 a = 19,3  
 b = 17,6  
 c = 10,0  
 d = 3,3  
 e = 4,3

A 75 16 000



A 75 16 010

A 75 16 018



A 76 16 000



A 76 16 008

 a = 16,4  
 b = 14,6  
 c = 10,0  
 d = 3,3  
 e = 4,3  
 f = 10,2

 a = 16,0  
 b = 14,8  
 c = 8,3  
 d = 3,3  
 e = 4,3



A 51 16 000

**RUNDKNOPF**
**FLÜGELKNOPF**
**KNEBELKNOPF**
**DECKEL**

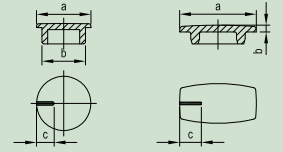

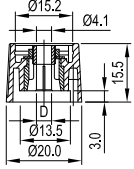
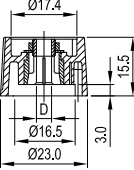
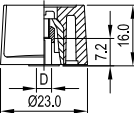
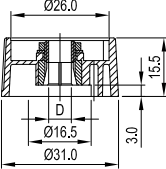
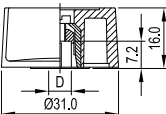
...100 = Markierung weiß, ansonsten schwarz

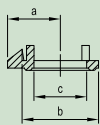

Größe Ø	Knopfform	Achsbohrung D	Knopfvarianten				a	b	c	Deckelvarianten		
			flügellos	flügellos	flügellos	flügellos				ohne Markierung	mit Markierung	
20	<b>RUND-KNOPF</b> 	4 mm, durchgehend	A 25 20 040	A 26 20 040			17,5	15,2	5,5	●	A 41 20 000	A 41 20 100
		6 mm, abgesetzt	A 25 20 060	A 26 20 060	A 25 20 068	A 26 20 068				●	A 41 20 002	A 41 20 102
		1/4", abgesetzt	A 25 20 630							●	A 41 20 004	A 41 20 104
23	<b>RUND-KNOPF</b> 	4 mm, durchgehend	A 25 23 040	A 26 23 040			20,4	17,4	6,5	●	A 41 23 000	A 41 23 100
		6 mm, durchgehend	A 25 23 060	A 26 23 060	A 25 23 068	A 26 23 068				●	A 41 23 002	A 41 23 102
		1/4", durchgehend	A 25 23 630		A 25 23 638					●	A 41 23 004	A 41 23 105
	<b>KNEBEL-KNOPF</b> 	4 mm, abgesetzt		A 24 23 040		20,9	1,2	6,5	●	A 50 23 000	A 50 23 100	
6 mm, abgesetzt			A 24 23 060		A 24 23 068				●	A 50 23 008	A 50 23 108	
31	<b>RUND-KNOPF</b> 	6 mm, durchgehend	A 25 31 060	A 26 31 060	A 25 31 068	A 26 31 068	28,4	26,0	9,0	●	A 41 31 000	A 41 31 100
		1/4", durchgehend	A 25 31 630							●	A 41 31 002	A 41 31 102
										●	A 41 31 005	
	<b>KNEBEL-KNOPF</b> 	6 mm, abgesetzt		A 24 31 060		29,0	1,4	9,5	●	A 50 31 000	A 50 31 100	
					A 24 31 068				●	A 50 31 008	A 50 31 107	
									●		A 50 31 108	

**PFEILSCHEIBE**
**SCHEIBE**
**SKALENSCHEIBE**
**STATOR**
**MUTTERABDECKUNG**

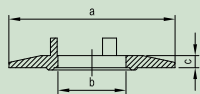
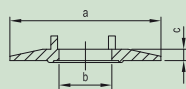
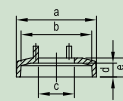
...010 = Markierung weiß

 ...0 = Symbole schwarz  
 ...9 = Symbole silber

 Markierung  
 schwarz

 a = 13,0  
 b = 20,0  
 c = 12,0

A 42 20 000



A 42 20 002



A 42 20 008

 a = 14,3  
 b = 23,0  
 c = 16,5

A 42 23 000



A 42 23 002



A 42 23 008

 a = 31,0  
 b = 16,5  
 c = 1,3

A 73 23 010

 a = 40,0  
 b = 16,3  
 c = 1,3

A 44 23 010



A 44 23 020



A 44 23 039



A 44 23 060

 a = 23,0  
 b = 10,2  
 c = 20,0

A 60 23 019

 a = 23,3  
 b = 20,0  
 c = 13,7  
 d = 3,3  
 e = 4,3

A 51 23 000



A 51 23 008

 a = 19,5  
 b = 31,0  
 c = 16,5

A 42 31 000



A 42 31 002



A 42 31 008

 a = 40,0  
 b = 16,5  
 c = 1,6

A 73 31 000

A 73 31 010

 a = 49,9  
 b = 16,5  
 c = 1,5

A 44 31 010



A 44 31 060

 a = 31,1  
 b = 28,0  
 c = 15,5  
 d = 3,3  
 e = 4,8



A 51 31 000







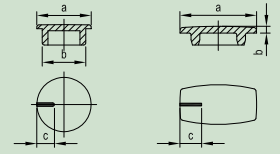

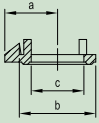
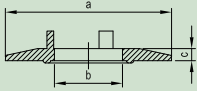
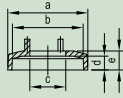

A 51 31 008

**RUNDKNOPF**
**KNEBELKNOPF**
**DECKEL**

...100 = Markierung weiß, ansonsten schwarz



Größe Ø	Knopfform	Achsb Bohrung D	Cover Profiles				a	b	c	Markierung	
			1	2	3	4				ohne Markierung	mit Markierung
40	<b>RUND-KNOPF</b> 	6 mm, durchgehend	A 25 40 060	A 26 40 060	A 25 40 068	A 26 40 068	37,4	34,4	12,5	● A 41 40 000	A 41 40 100
		8 mm, durchgehend	A 25 40 080							● A 41 40 002	
40	<b>KNEBEL-KNOPF</b> 	6 mm, abgesetzt		A 24 40 060		A 24 40 068	37,9	1,6	13,0	● A 50 40 000	A 50 40 100
						● A 50 40 008				A 50 40 108	
50	<b>RUND-KNOPF</b> 	6 mm, durchgehend	A 25 50 060	A 26 50 060	A 25 50 068		47,4	44,4	14,5	● A 41 50 000	A 41 50 100
						● A 41 50 008				A 41 50 107	

PFEILSCHEIBE		SCHEIBE		SKALENSCHEIBE		STATOR		MUTTERABDECKUNG	
		<p>...010 = Markierung weiß</p> 							
		 						 	
<p>a = 24,5 b = 40,0 c = 25,0</p>  	<p>A 42 40 000</p> <hr/> <p>A 42 40 008</p>		<p>a = 50,1 b = 24,0 c = 1,8</p> 	<p>A 73 40 010</p>				<p>a = 40,3 b = 36,8 c = 20,0 d = 3,1 e = 4,6</p> 	
								<p>A 51 40 000</p>	



## FÜR RUND- / FLÜGEL- / KNEBELKNÖPFE / COM-KNOBS

Bestell-Nummer	Artikel	Ausführung / Verwendung	Maße in mm	Abbildung
A 61 16 010	Feststeller mit Stator	Nur für Rund- und Flügelknöpfe Größe 16 mit Skalenscheibe. Glasklar, Markierung schwarz.		
A 61 00 000	Feststeller	Universell für Rund- und Flügelknöpfe sowie COM-KNOBS mit Skalenscheibe verwendbar.		
Rundknöpfe $\phi$ D <sub>1</sub> D <sub>2</sub> D <sub>3</sub>	Justierschlüssel	Für genaues Einstellen von Kombiknöpfen (Rundknöpfe) mit Markierungsstrich, Skalen- und Pfeilscheiben. Problemlose Knopfmontage.		
A 64 02 005	10 13,5 16			
A 64 03 005	20 23 31			
G $\phi$	Rundmutter	Zur Befestigung der Potentiometer an Blenden. Passt unter Knopf und Mutterabdeckung (Rundknöpfe / Flügelknöpfe / Knebelknöpfe / COM-KNOBS $\phi$ 10 / 13,5 / 16 / 20 / 23 / 31 / 40 / 50).		
A 62 07 009	M 7 x 0,75 13,5			
A 62 10 009	M 10 x 0,75 12,5			
A 62 95 009	3/8" - 32G 12,5			
A 63 00 000	Steckschlüssel	Zum Anziehen der Rundmuttern.		
Bohrung	Verdrehungsschutz	Ermöglicht verdrehungssichere Knopfmontage auf Profilachsen 6 / 4,6 mm. Geeignet für Rund- und Flügelknöpfe $\phi$ 20 bis 50 mit 6 mm Achsbohrung (nicht für COM-KNOBS passend).		
A 66 00 064	6 / 4,6			