



DAS PRODUKT

Der Name KOMBIKNÖPFE steht für eine äußerst zweckmäßige Drehknopfreihe mit zuverlässigem Spannzangensystem. Als RUND-, FLÜGEL- und KNEBELKNÖPFE mit großem Zubehörprogramm bieten sie vielfältige Einsatzmöglichkeiten.

ANWENDUNGEN

Vielfach bewährt für elektromechanische Drehpotentiometer mit runden Wellenenden nach DIN 41 591, z.B. im Bereich Messen – Steuern – Regeln.

IHRE VORTEILE

Bewährtes Spannzangensystem: Bequeme Knopfmontage von vorn und leichte Justierung (mit Justierschlüssel, siehe Zubehör Seite 18). Sicherer Sitz der Knöpfe auf der Achse. Die Größen 10 und 13 haben Sackbohrung und Schraubenbefestigung. Ab Knopfgröße 23 durchgehende ① Achsbohrung (Größen 16 + 20 abgestuft ②, ausgenommen 4 mm-Achsbohrung).

Rund-, Flügel- und Knebelknöpfe mit einheitlichem Design und matter Oberfläche.



Reichhaltiges, funktionelles Zubehör von farbigen Deckeln bis zu glasklaren Skalenscheiben. Einfaches Zusammenzustecken.

Wir fertigen unser Kombiknopfprogramm unter Berücksichtigung von Mindestlosgrößen auch in Sonderfarben. Nennen Sie uns bitte Ihre Wünsche und Bedarfsmengen.

MATERIAL







Kombiknöpfe, Deckel, Pfeilscheiben, Scheiben und Mutterabdeckung: ABS (UL 94 HB).
Skalenscheiben: Polycarbonat.
Stator: Al-Blech 0,5 mm mit Selbstklebefolie.
Siehe Kunststoffeigenschaften Seite 29.

Kombiknöpfe, Scheibe, Mutterabdeckung



Schwarz, RAL 9005 
Staubgrau, RAL 7037 

Deckel

(größen-/ typenabhängig)

Schwarz, RAL 9005 
Rot, RAL F12/0-10 
Gelb, RAL F12/0-1 
Grün, RAL F12/0-43 
Blau, RAL 5012 
Kieselgrau, RAL 7032 
Staubgrau, RAL 7037 

Pfeilscheibe

Schwarz, RAL 9005 
Rot, RAL F12/0-10 
Staubgrau, RAL 7037 

Skalenscheibe

Glasklar, glänzend 
mit/ohne Beschriftung

Stator

Aluminium, 
Markierung schwarz

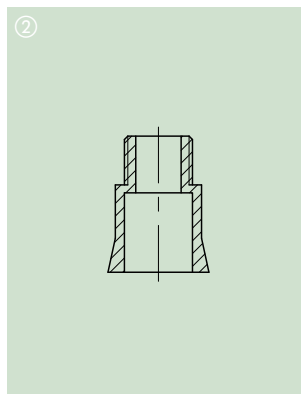
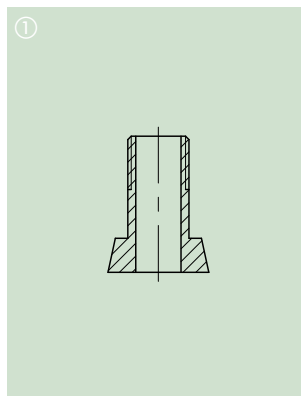
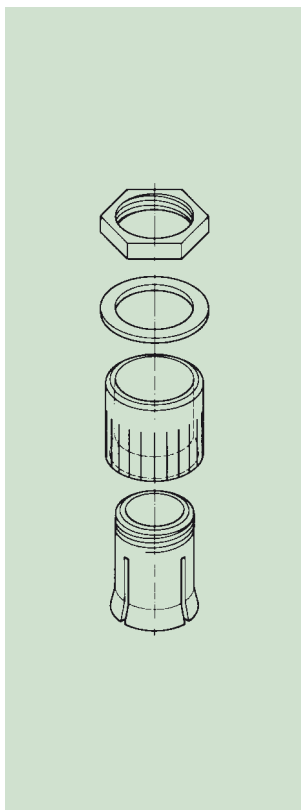







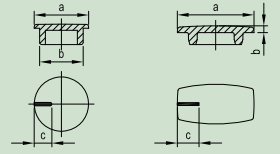

KNOPFARTEN

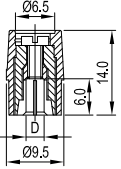
Knopf ø	Drehmoment (Nm)		RUNDKNOPF		FLÜGELKNOPF		KNEBELKNOPF	
	Montage	Funktion	Achsbohrung		Achsbohrung		Achsbohrung	
9	0,4	0,4	4 mm		-	-	-	-
10	0,4	0,4	3 mm		-	-	-	-
	0,4	0,4	4 mm		-	-	-	-
	0,4	0,4	1/8"		-	-	-	-
13,5	0,5	0,5	4 mm		-		-	-
	0,7	0,6	6 mm		6 mm		-	-
16	0,5	0,5	-		-		3 mm	
	0,6	0,5	4 mm		-		4 mm	
	0,8	0,7	6 mm		6 mm		-	
	0,8	0,7	1/4"		-		-	
20	0,8	0,7	4 mm		-	-	-	-
	1,0	0,9	6 mm		-	-	-	
	1,0	0,9	1/4"		-	-	-	
23	1,0	0,8	4 mm		-	-	4 mm	
	1,2	1,0	6 mm		-	6 mm		
	1,2	1,0	1/4"		-	-		
31	1,8	1,6	6 mm		-	-	6 mm	
	1,8	1,6	1/4"		-	-	-	
40	2,5	1,6	6 mm		-	-	6 mm	
	2,8	1,8	8 mm		-	-	-	
50	3,0	1,8	6 mm		-	-	-	-
	3,5	2,0	8 mm		-	-	-	

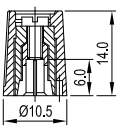
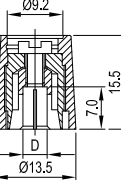
RUNDKNOPF
FLÜGELKNOPF
KNEBELKNOPF
DECKEL

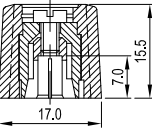
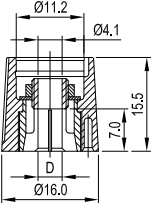
...100 = Markierung weiß, ansonsten schwarz

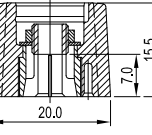
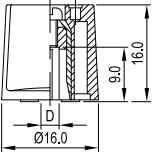

Größe ø	Knopfform	Achsbohrung D	Achsbohrung				Markierung									
			ohne Markierung	mit Markierung	ohne Markierung	mit Markierung										
9	RUND-KNOPF 	4 mm, abgesetzt		A 26 09 040			a = 8,0 b = 6,5 c = 2,6		A 41 10 000	A 41 10 100						
10	RUND-KNOPF 	3 mm, abgesetzt	A 25 10 030	A 26 10 030	A 25 10 038	A 26 10 038										
		1/8", abgesetzt	A 25 10 320	A 26 10 320												
		4 mm, abgesetzt	A 25 10 040	A 26 10 040	A 25 10 048	A 26 10 048										
13,5	RUND-KNOPF 	4 mm, abgesetzt	A 25 13 040	A 26 13 040	A 25 13 048	A 26 13 048			a = 11,2 b = 9,2 c = 3,0		A 41 13 000	A 41 13 100				
		6 mm, abgesetzt	A 25 13 060	A 26 13 060	A 25 13 068	A 26 13 068										
	FLÜGEL-KNOPF 	6 mm, abgesetzt		A 28 13 060												
16	RUND-KNOPF 	4 mm, durchgehend	A 25 16 040	A 26 16 040							a = 13,5 b = 11,2 c = 4,0		A 41 16 000	A 41 16 100		
		6 mm, abgesetzt	A 25 16 060	A 26 16 060	A 25 16 068	A 26 16 068										
		1/4", abgesetzt	A 25 16 630	A 26 16 630	A 25 16 638											
	FLÜGEL-KNOPF 	6 mm, abgesetzt		A 28 16 060												
	KNEBEL-KNOPF 	3 mm, abgesetzt		A 24 16 030			a = 14,0 b = 1,2 c = 4,0				A 50 16 000	A 50 16 100				
		4 mm, abgesetzt	A 23 16 040	A 24 16 040		A 24 16 048							A 50 16 108			

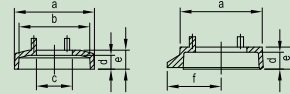
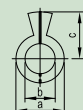
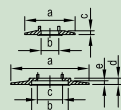
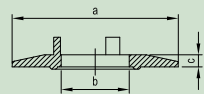
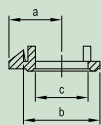
PFEILSCHEIBE
SCHEIBE
SKALENSCHLEIBE
STATOR
MUTTERABDECKUNG

...010 = Markierung weiß

 ...0 = Symbole schwarz
 ...9 = Symbole silber

 Markierung
 schwarz

 ...010 = Markierung weiß
 ...018 = Markierung schwarz

 a = 7,0
 b = 10,1
 c = 7,0

A 42 10 000



A 42 10 002



A 42 10 008

 a = 20,0
 b = 7,0
 c = 1,5

A 44 10 060

 (nur für
 Größe 10)

 a = 15,5
 b = 14,0
 c = 7,0
 d = 2,9
 e = 3,7

A 75 10 000



A 75 10 010

A 75 10 018

 (nur für
 Größe 10)

 a = 9,0
 b = 13,6
 c = 8,0

A 42 13 000



A 42 13 002



A 42 13 008

 a = 26,0
 b = 8,0
 c = 1,5

A 44 13 010



A 44 13 020



A 44 13 049



A 44 13 060

 a = 17,5
 b = 15,7
 c = 9,0
 d = 3,2
 e = 4,3

A 75 13 000



A 75 13 010

A 75 13 018

 a = 10,5
 b = 16,3
 c = 10,0

A 42 16 000



A 42 16 002



A 42 16 008

 a = 23,0
 b = 10,0
 c = 1,3

A 73 16 000

A 73 16 010

 a = 31,0
 b = 14,5
 c = 10,0
 d = 2,5
 e = 1,7

A 44 16 001



A 44 16 010



A 44 16 020



A 44 16 060

 (ø 16
 mit ange-
 spritzter
 Mutter-
 abdek-
 kung)

 a=16,0
 b=10,1
 c=15,5

A 60 16 019

 a = 19,3
 b = 17,6
 c = 10,0
 d = 3,3
 e = 4,3

A 75 16 000



A 75 16 010

A 75 16 018



A 76 16 000



A 76 16 008

 a = 16,4
 b = 14,6
 c = 10,0
 d = 3,3
 e = 4,3
 f = 10,2

 a = 16,0
 b = 14,8
 c = 8,3
 d = 3,3
 e = 4,3



A 51 16 000

RUNDKNOPF
FLÜGELKNOPF
KNEBELKNOPF
DECKEL

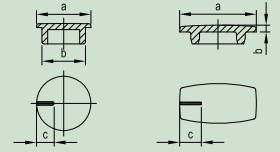

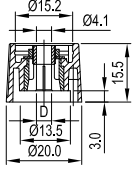
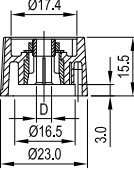
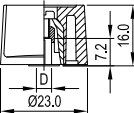
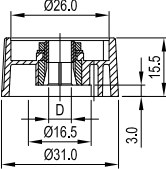
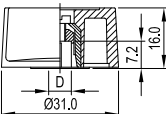
...100 = Markierung weiß, ansonsten schwarz

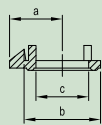

Größe Ø	Knopfform	Achsb Bohrung D	Knopfvarianten				a	b	c	Deckelvarianten		
			flügellos	flügellos	flügellos	flügellos				ohne Markierung	mit Markierung	
20	RUND-KNOPF 	4 mm, durchgehend	A 25 20 040	A 26 20 040			17,5	15,2	5,5	●	A 41 20 000	A 41 20 100
		6 mm, abgesetzt	A 25 20 060	A 26 20 060	A 25 20 068	A 26 20 068				●	A 41 20 002	A 41 20 102
		1/4", abgesetzt	A 25 20 630							●	A 41 20 004	A 41 20 104
23	RUND-KNOPF 	4 mm, durchgehend	A 25 23 040	A 26 23 040			20,4	17,4	6,5	●	A 41 23 000	A 41 23 100
		6 mm, durchgehend	A 25 23 060	A 26 23 060	A 25 23 068	A 26 23 068				●	A 41 23 002	A 41 23 102
		1/4", durchgehend	A 25 23 630		A 25 23 638					●	A 41 23 004	A 41 23 105
	KNEBEL-KNOPF 	4 mm, abgesetzt		A 24 23 040		20,9	1,2	6,5	●	A 50 23 000	A 50 23 100	
6 mm, abgesetzt			A 24 23 060		A 24 23 068				●	A 50 23 008	A 50 23 108	
31	RUND-KNOPF 	6 mm, durchgehend	A 25 31 060	A 26 31 060	A 25 31 068	A 26 31 068	28,4	26,0	9,0	●	A 41 31 000	A 41 31 100
		1/4", durchgehend	A 25 31 630							●	A 41 31 002	A 41 31 102
										●	A 41 31 005	A 41 31 106
	KNEBEL-KNOPF 	6 mm, abgesetzt		A 24 31 060		29,0	1,4	9,5	●	A 50 31 000	A 50 31 100	
				A 24 31 068					●	A 50 31 008	A 50 31 107	
									●	A 41 31 006	A 41 31 108	
									●	A 41 31 007		
									●	A 41 31 008		

PFEILSCHEIBE
SCHEIBE
SKALENSCHLEIBE
STATOR
MUTTERABDECKUNG

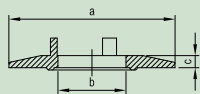
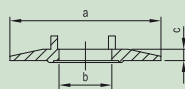
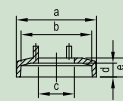
...010 = Markierung weiß

 ...0 = Symbole schwarz
 ...9 = Symbole silber

 Markierung
 schwarz

 a = 13,0
 b = 20,0
 c = 12,0

A 42 20 000



A 42 20 002



A 42 20 008

 a = 36,0
 b = 12,0
 c = 1,5

A 44 20 001



A 44 20 010



A 44 20 060

 a=20,0
 b=10,1
 c=18,0

A 60 20 019

 a = 14,3
 b = 23,0
 c = 16,5

A 42 23 000



A 42 23 002



A 42 23 008

 a = 31,0
 b = 16,5
 c = 1,3

A 73 23 010

 a = 40,0
 b = 16,3
 c = 1,3

A 44 23 010



A 44 23 020



A 44 23 039



A 44 23 060

 a=23,0
 b=10,2
 c=20,0

A 60 23 019

 a = 23,3
 b = 20,0
 c = 13,7
 d = 3,3
 e = 4,3

A 51 23 000



A 51 23 008

 a = 19,5
 b = 31,0
 c = 16,5

A 42 31 000



A 42 31 002



A 42 31 008

 a = 40,0
 b = 16,5
 c = 1,6

A 73 31 000

A 73 31 010

 a = 49,9
 b = 16,5
 c = 1,5

A 44 31 010



A 44 31 060

 a = 31,1
 b = 28,0
 c = 15,5
 d = 3,3
 e = 4,8



A 51 31 000







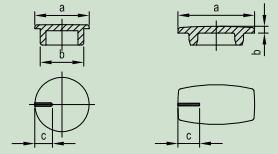

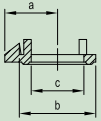
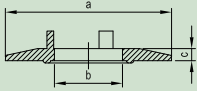
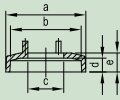

A 51 31 008

RUNDKNOPF
KNEBELKNOPF
DECKEL

...100 = Markierung weiß, ansonsten schwarz



Größe Ø	Knopfform	Achsb Bohrung D	Cover Profiles				a	b	c	Markierung	
			1	2	3	4				ohne Markierung	mit Markierung
40	RUND-KNOPF 	6 mm, durchgehend	A 25 40 060	A 26 40 060	A 25 40 068	A 26 40 068	37,4	34,4	12,5	● A 41 40 000	A 41 40 100
		8 mm, durchgehend	A 25 40 080							● A 41 40 002	
40	KNEBEL-KNOPF 	6 mm, abgesetzt		A 24 40 060		A 24 40 068	37,9	1,6	13,0	● A 50 40 000	A 50 40 100
						● A 50 40 008				A 50 40 108	
50	RUND-KNOPF 	6 mm, durchgehend	A 25 50 060	A 26 50 060	A 25 50 068		47,4	44,4	14,5	● A 41 50 000	A 41 50 100
						● A 41 50 008				A 41 50 107	

PFEILSCHEIBE		SCHEIBE		SKALENSCHEIBE		STATOR		MUTTERABDECKUNG		
		<p>...010 = Markierung weiß</p> 								
		 						 		
<p>a = 24,5 b = 40,0 c = 25,0</p>  	<p>A 42 40 000</p> <hr/> <p>A 42 40 008</p>		<p>a = 50,1 b = 24,0 c = 1,8</p> 	<p>A 73 40 010</p>						
								<p>a = 40,3 b = 36,8 c = 20,0 d = 3,1 e = 4,6</p> 	<p>A 51 40 000</p>	

FÜR RUND- / FLÜGEL- / KNEBELKNÖPFE / COM-KNOBS

Bestell-Nummer	Artikel	Ausführung / Verwendung	Maße in mm	Abbildung
A 61 16 010	Feststeller mit Stator	Nur für Rund- und Flügelknöpfe Größe 16 mit Skalenscheibe. Glasklar, Markierung schwarz.		
A 61 00 000	Feststeller	Universell für Rund- und Flügelknöpfe sowie COM-KNOBS mit Skalenscheibe verwendbar.	<p>Montageplatte</p>	
	Justierschlüssel	Für genaues Einstellen von Kombiknöpfen (Rundknöpfe) mit Markierungsstrich, Skalen- und Pfeilscheiben. Problemlose Knopfmontage.		
	Rundknöpfe ϕ D ₁ D ₂ D ₃			
A 64 02 005	10 13,5 16			
A 64 03 005	20 23 31			
	Rundmutter	Zur Befestigung der Potentiometer an Blenden. Passt unter Knopf und Mutterabdeckung (Rundknöpfe / Flügelknöpfe / Knebelknöpfe / COM-KNOBS ϕ 10 / 13,5 / 16 / 20 / 23 / 31 / 40 / 50).		
A 62 07 009	M 7 x 0,75 13,5			
A 62 10 009	M 10 x 0,75 12,5			
A 62 95 009	3/8" - 32G 12,5			
A 63 00 000	Steckschlüssel	Zum Anziehen der Rundmutter.		
	Verdrehungsschutz	Ermöglicht verdrehungssichere Knopfmontage auf Profilachsen 6 / 4,6 mm. Geeignet für Rund- und Flügelknöpfe ϕ 20 bis 50 mit 6 mm Achsbohrung (nicht für COM-KNOBS passend).		
A 66 00 064	Bohrung 6 / 4,6			