



DAS PRODUKT

Der Name KOMBIKNÖPFE steht für eine äußerst zweckmäßige Drehknopfreihe mit zuverlässigem Spannzangensystem. Als RUND-, FLÜGEL- und KNEBELKNÖPFE mit großem Zubehörprogramm bieten sie vielfältige Einsatzmöglichkeiten.

ANWENDUNGEN

Vielfach bewährt für elektromechanische Drehpotentiometer mit runden Wellenenden nach DIN 41 591, z.B. im Bereich Messen – Steuern – Regeln.

IHRE VORTEILE

Bewährtes Spannzangensystem: Bequeme Knopfmontage von vorn und leichte Justierung (mit Justierschlüssel, siehe Zubehör Seite 18). Sicherer Sitz der Knöpfe auf der Achse. Die Größen 10 und 13 haben Sackbohrung und Schraubenbefestigung. Ab Knopfgröße 23 durchgehende ① Achsbohrung (Größen 16 + 20 abgestuft ②, ausgenommen 4 mm-Achsbohrung).

Rund-, Flügel- und Knebelknöpfe mit einheitlichem Design und matter Oberfläche.



Reichhaltiges, funktionelles Zubehör von farbigen Deckeln bis zu glasklaren Skalenscheiben. Einfaches Zusammenzustecken.

Wir fertigen unser Kombiknopfprogramm unter Berücksichtigung von Mindestlosgrößen auch in Sonderfarben. Nennen Sie uns bitte Ihre Wünsche und Bedarfsmengen.

MATERIAL







Kombiknöpfe, Deckel, Pfeilscheiben, Scheiben und Mutterabdeckung: ABS (UL 94 HB).
Skalenscheiben: Polycarbonat.
Stator: Al-Blech 0,5 mm mit Selbstklebefolie.
Siehe Kunststoffeigenschaften Seite 29.

Kombiknöpfe, Scheibe, Mutterabdeckung



Schwarz, RAL 9005 
Staubgrau, RAL 7037 

Deckel

(größen-/ typenabhängig)

Schwarz, RAL 9005 
Rot, RAL F12/0-10 
Gelb, RAL F12/0-1 
Grün, RAL F12/0-43 
Blau, RAL 5012 
Kieselgrau, RAL 7032 
Staubgrau, RAL 7037 

Pfeilscheibe

Schwarz, RAL 9005 
Rot, RAL F12/0-10 
Staubgrau, RAL 7037 

Skalenscheibe

Glasklar, glänzend 
mit/ohne Beschriftung

Stator

Aluminium, 
Markierung schwarz

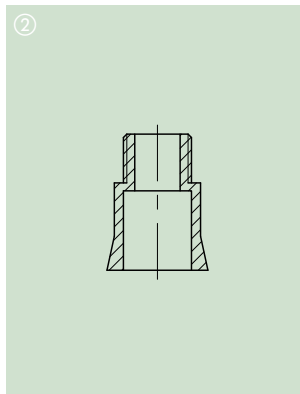
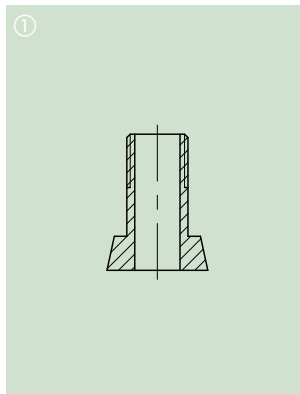
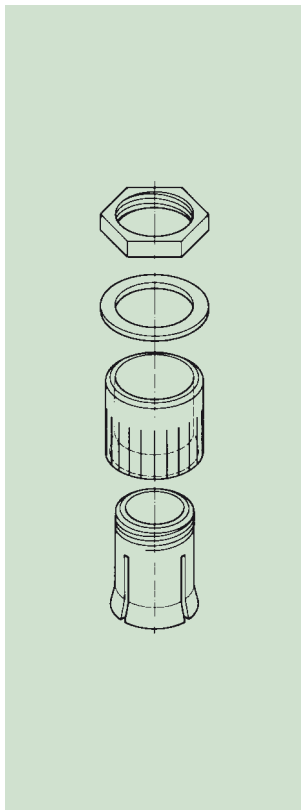

KNOPFARTEN

Knopf Ø	Drehmoment (Nm)		RUNDKNOPF		FLÜGELKNOPF		KNEBELKNOPF	
	Montage	Funktion	Achsbohrung		Achsbohrung		Achsbohrung	
9	0,4	0,4	4 mm		-	-	-	-
10	0,4	0,4	3 mm		-	-	-	-
	0,4	0,4	4 mm		-	-	-	-
	0,4	0,4	1/8"		-	-	-	-
13,5	0,5	0,5	4 mm		-		-	-
	0,7	0,6	6 mm		6 mm		-	-
16	0,5	0,5	-		-		3 mm	
	0,6	0,5	4 mm		-		4 mm	
	0,8	0,7	6 mm		6 mm		-	
	0,8	0,7	1/4"		-		-	
20	0,8	0,7	4 mm		-	-	-	-
	1,0	0,9	6 mm		-	-	-	
	1,0	0,9	1/4"		-	-	-	
23	1,0	0,8	4 mm		-	-	4 mm	
	1,2	1,0	6 mm		-	6 mm		
	1,2	1,0	1/4"		-	-		
31	1,8	1,6	6 mm		-	-	6 mm	
	1,8	1,6	1/4"		-	-	-	
40	2,5	1,6	6 mm		-	-	6 mm	
	2,8	1,8	8 mm		-	-	-	
50	3,0	1,8	6 mm		-	-	-	-
	3,5	2,0	8 mm		-	-	-	

KOMBIKNÖPFE

RUNDKNOPF
FLÜGELKNOPF
KNEBELKNOPF
DECKEL

...100 = Markierung weiß, ansonsten schwarz

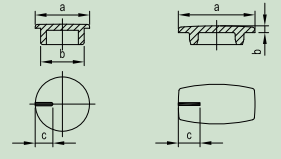

Größe ø	Knopfform	Achsbohrung D					ohne Markierung	mit Markierung
9	RUND- KNOPF	4 mm, abgesetzt		A 26 09 040			a = 8,0 b = 6,5 c = 2,6	 A 41 10 000 A 41 10 100 A 41 10 002 A 41 10 102 A 41 10 004 A 41 10 104 A 41 10 005 A 41 10 105 A 41 10 006 A 41 10 106 A 41 10 007 A 41 10 008 A 41 10 108
10	RUND- KNOPF	3 mm, abgesetzt	A 25 10 030	A 26 10 030	A 25 10 038	A 26 10 038	a = 11,2 b = 9,2 c = 3,0	 A 41 13 000 A 41 13 100 A 41 13 002 A 41 13 102 A 41 13 004 A 41 13 104 A 41 13 005 A 41 13 105 A 41 13 006 A 41 13 106 A 41 13 007 A 41 13 008 A 41 13 108
		1/8", abgesetzt	A 25 10 320	A 26 10 320				
		4 mm, abgesetzt	A 25 10 040	A 26 10 040	A 25 10 048	A 26 10 048		
13,5	RUND- KNOPF	4 mm, abgesetzt	A 25 13 040	A 26 13 040	A 25 13 048	A 26 13 048	a = 11,2 b = 9,2 c = 3,0	 A 41 13 000 A 41 13 100 A 41 13 002 A 41 13 102 A 41 13 004 A 41 13 104 A 41 13 005 A 41 13 105 A 41 13 006 A 41 13 106 A 41 13 007 A 41 13 008 A 41 13 108
		6 mm, abgesetzt	A 25 13 060	A 26 13 060	A 25 13 068	A 26 13 068		
	FLÜGEL- KNOPF	6 mm, abgesetzt		A 28 13 060				
16	RUND- KNOPF	4 mm, durchgehend	A 25 16 040	A 26 16 040			a = 13,5 b = 11,2 c = 4,0	 A 41 16 000 A 41 16 100 A 41 16 002 A 41 16 102 A 41 16 004 A 41 16 005 A 41 16 006 A 41 16 106 A 41 16 007 A 41 16 107 A 41 16 008 A 41 16 108
		6 mm, abgesetzt	A 25 16 060	A 26 16 060	A 25 16 068	A 26 16 068		
		1/4", abgesetzt	A 25 16 630	A 26 16 630	A 25 16 638			
	FLÜGEL- KNOPF	6 mm, abgesetzt		A 28 16 060				
	KNEBEL- KNOPF	3 mm, abgesetzt		A 24 16 030			a = 14,0 b = 1,2 c = 4,0	 A 50 16 000 A 50 16 100 A 50 16 108
		4 mm, abgesetzt	A 23 16 040	A 24 16 040		A 24 16 048		

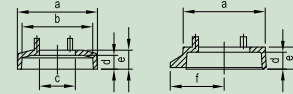
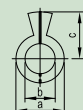
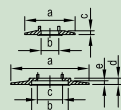
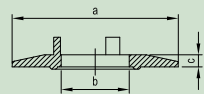
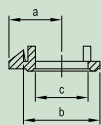
PFEILSCHEIBE
SCHEIBE
SKALENSCHEIBE
STATOR
MUTTERABDECKUNG

...010 = Markierung weiß

 ...0 = Symbole schwarz
 ...9 = Symbole silber

 Markierung
 schwarz

 ...010 = Markierung weiß
 ...018 = Markierung schwarz

 a = 7,0
 b = 10,1
 c = 7,0

A 42 10 000



A 42 10 002



A 42 10 008

 a = 20,0
 b = 7,0
 c = 1,5

A 44 10 060

 (nur für
 Größe 10)

 a = 15,5
 b = 14,0
 c = 7,0
 d = 2,9
 e = 3,7

A 75 10 000



A 75 10 010

A 75 10 018

 (nur für
 Größe 10)

 a = 9,0
 b = 13,6
 c = 8,0

A 42 13 000



A 42 13 002



A 42 13 008

 a = 26,0
 b = 8,0
 c = 1,5

A 44 13 010



A 44 13 020



A 44 13 049



A 44 13 060

 a = 17,5
 b = 15,7
 c = 9,0
 d = 3,2
 e = 4,3

A 75 13 000



A 75 13 010

A 75 13 018

 a = 10,5
 b = 16,3
 c = 10,0

A 42 16 000



A 42 16 002



A 42 16 008

 a = 23,0
 b = 10,0
 c = 1,3

A 73 16 000

A 73 16 010

 a = 31,0
 b = 14,5
 c = 10,0
 d = 2,5
 e = 1,7

A 44 16 001



A 44 16 010



A 44 16 020



A 44 16 060

 (ø 16
 mit ange-
 spritzter
 Mutter-
 abdek-
 kung)

 a=16,0
 b=10,1
 c=15,5

A 60 16 019

 a = 19,3
 b = 17,6
 c = 10,0
 d = 3,3
 e = 4,3

A 75 16 000



A 75 16 010

A 75 16 018



A 76 16 000



A 76 16 008

 a = 16,4
 b = 14,6
 c = 10,0
 d = 3,3
 e = 4,3
 f = 10,2









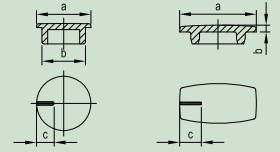

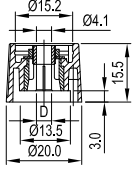
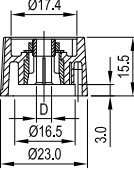
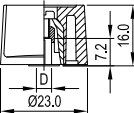
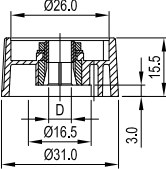
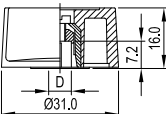



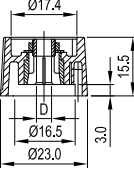







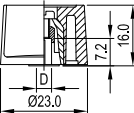

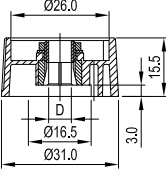
 a = 16,0
 b = 14,8
 c = 8,3
 d = 3,3
 e = 4,3

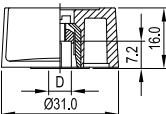

A 51 16 000

RUNDKNOPF
FLÜGELKNOPF
KNEBELKNOPF
DECKEL



...100 = Markierung weiß, ansonsten schwarz

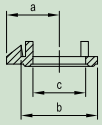

Größe Ø	Knopfform	Achsbohrung D	Achsbohrung				ohne Markierung	mit Markierung
			4 mm, durchgehend	6 mm, durchgehend	1/4", durchgehend	6 mm, abgesetzt		
20	RUND- KNOPF 	4 mm, durchgehend	A 25 20 040	A 26 20 040			a = 17,5 b = 15,2 c = 5,5	 A 41 20 000 A 41 20 100  A 41 20 002 A 41 20 102  A 41 20 004 A 41 20 104  A 41 20 005  A 41 20 006 A 41 20 106  A 41 20 007 A 41 20 107  A 41 20 008 A 41 20 108
		6 mm, abgesetzt	A 25 20 060	A 26 20 060	A 25 20 068	A 26 20 068		
		1/4", abgesetzt	A 25 20 630					
23	RUND- KNOPF 	4 mm, durchgehend	A 25 23 040	A 26 23 040			a = 20,4 b = 17,4 c = 6,5	 A 41 23 000 A 41 23 100  A 41 23 002 A 41 23 102  A 41 23 004  A 41 23 105  A 41 23 006 A 41 23 106  A 41 23 007 A 41 23 107  A 41 23 008 A 41 23 108
		6 mm, durchgehend	A 25 23 060	A 26 23 060	A 25 23 068	A 26 23 068		
		1/4", durchgehend	A 25 23 630		A 25 23 638			
	KNEBEL- KNOPF 	4 mm, abgesetzt		A 24 23 040			a = 20,9 b = 1,2 c = 6,5	 A 50 23 000 A 50 23 100  A 50 23 008 A 50 23 108
6 mm, abgesetzt			A 24 23 060		A 24 23 068			
31	RUND- KNOPF 	6 mm, durchgehend	A 25 31 060	A 26 31 060	A 25 31 068	A 26 31 068	a = 28,4 b = 26,0 c = 9,0	 A 41 31 000 A 41 31 100  A 41 31 002 A 41 31 102  A 41 31 005  A 41 31 006  A 41 31 007  A 41 31 008 A 41 31 108
		1/4", durchgehend	A 25 31 630					
	KNEBEL- KNOPF 	6 mm, abgesetzt		A 24 31 060		A 24 31 068	a = 29,0 b = 1,4 c = 9,5	 A 50 31 000 A 50 31 100  A 50 31 107  A 50 31 008 A 50 31 108

PFEILSCHEIBE
SCHEIBE
SKALENSCHEIBE
STATOR
MUTTERABDECKUNG

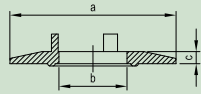
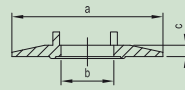
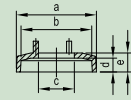
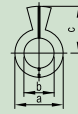
...010 = Markierung weiß

 ...0 = Symbole schwarz
 ...9 = Symbole silber

 Markierung
 schwarz

 a = 13,0
 b = 20,0
 c = 12,0

A 42 20 000



A 42 20 002



A 42 20 008

 a = 36,0
 b = 12,0
 c = 1,5

A 44 20 001



A 44 20 010



A 44 20 060

 a=20,0
 b=10,1
 c=18,0

A 60 20 019

 a = 14,3
 b = 23,0
 c = 16,5

A 42 23 000



A 42 23 002



A 42 23 008

 a = 31,0
 b = 16,5
 c = 1,3

A 73 23 010

 a = 40,0
 b = 16,3
 c = 1,3

A 44 23 010



A 44 23 020



A 44 23 039



A 44 23 060

 a=23,0
 b=10,2
 c=20,0

A 60 23 019

 a = 23,3
 b = 20,0
 c = 13,7
 d = 3,3
 e = 4,3

A 51 23 000



A 51 23 008

 a = 19,5
 b = 31,0
 c = 16,5

A 42 31 000



A 42 31 002



A 42 31 008

 a = 40,0
 b = 16,5
 c = 1,6

A 73 31 000

A 73 31 010

 a = 49,9
 b = 16,5
 c = 1,5

A 44 31 010



A 44 31 060

 a = 31,1
 b = 28,0
 c = 15,5
 d = 3,3
 e = 4,8



A 51 31 000



A 51 31 008

RUNDKNOPF
KNEBELKNOPF
DECKEL

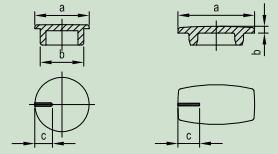
...100 = Markierung weiß, ansonsten schwarz



Größe Ø	Knopfform	Achsb Bohrung D	Cover Profiles				a	b	c	Markierung	
			1	2	3	4				ohne Markierung	mit Markierung
40	RUND- KNOPF 	6 mm, durchgehend	A 25 40 060	A 26 40 060	A 25 40 068	A 26 40 068	37,4	34,4	12,5	● A 41 40 000	A 41 40 100
		8 mm, durchgehend	A 25 40 080							● A 41 40 002	
40	KNEBEL- KNOPF 	6 mm, abgesetzt		A 24 40 060		A 24 40 068	37,9	1,6	13,0	● A 50 40 000	A 50 40 100
						● A 50 40 008				A 50 40 108	
50	RUND- KNOPF 	6 mm, durchgehend	A 25 50 060	A 26 50 060	A 25 50 068		47,4	44,4	14,5	● A 41 50 000	A 41 50 100
						● A 41 50 008				A 41 50 107	

PFEILSCHEIBE		SCHEIBE		SKALENSCHEIBE		STATOR		MUTTERABDECKUNG		
		...010 = Markierung weiß 								
a = 24,5 b = 40,0 c = 25,0		A 42 40 000 A 42 40 008		a = 50,1 b = 24,0 c = 1,8	A 73 40 010					
								a = 40,3 b = 36,8 c = 20,0 d = 3,1 e = 4,6		A 51 40 000

FÜR RUND- / FLÜGEL- / KNEBELKNÖPFE / COM-KNOBS

Bestell-Nummer	Artikel	Ausführung / Verwendung	Maße in mm	Abbildung	
A 61 16 010	Feststeller mit Stator	Nur für Rund- und Flügelknöpfe Größe 16 mit Skalenscheibe. Glasklar, Markierung schwarz.			
A 61 00 000	Feststeller	Universell für Rund- und Flügelknöpfe sowie COM-KNOBS mit Skalenscheibe verwendbar.	<p>Montageplatte</p>		
	Rundknöpfe ϕ D ₁ D ₂ D ₃	Justierschlüssel	Für genaues Einstellen von Kombiknöpfen (Rundknöpfe) mit Markierungsstrich, Skalen- und Pfeilscheiben. Problemlose Knopfmontage.		
A 64 02 005	10 13,5 16				
A 64 03 005	20 23 31				
	G ϕ	Rundmutter	Zur Befestigung der Potentiometer an Blenden. Passt unter Knopf und Mutterabdeckung (Rundknöpfe / Flügelknöpfe / Knebelknöpfe / COM-KNOBS ϕ 10 / 13,5 / 16 / 20 / 23 / 31 / 40 / 50).		
A 62 07 009	M 7 x 0,75 13,5				
A 62 10 009	M 10 x 0,75 12,5				
A 62 95 009	3/8" - 32G 12,5				
A 63 00 000	Steckschlüssel	Zum Anziehen der Rundmutter.			
	Bohrung	Verdrehungsschutz	Ermöglicht verdrehungssichere Knopfmontage auf Profilachsen 6 / 4,6 mm. Geeignet für Rund- und Flügelknöpfe ϕ 20 bis 50 mit 6 mm Achsbohrung (nicht für COM-KNOBS passend).		
A 66 00 064	6 / 4,6				