

Datenblatt | Artikelnummer: 235-747/331-000

Anreihbare Leiterplattenklemme; Drücker; 1,5 mm²; Rastermaß 5/5,08 mm;
1-polig; Push-in CAGE CLAMP®

www.wago.com/235-747/331-000



RoHS 
Compliant

BOMcheck.net

Farbe: 

Strombelastbarkeitskurve
Rastermaß 5 mm / Leiterquerschnitt 1,5 mm² „e“
In Anlehnung an: EN 60512-5-2 / Reduktionsfaktor 1

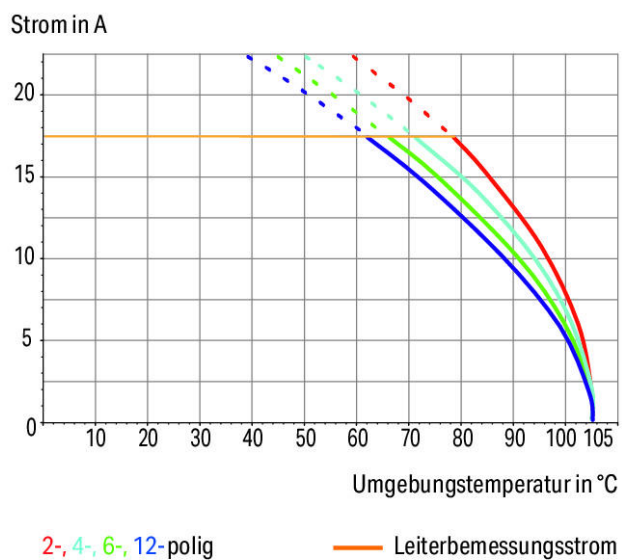

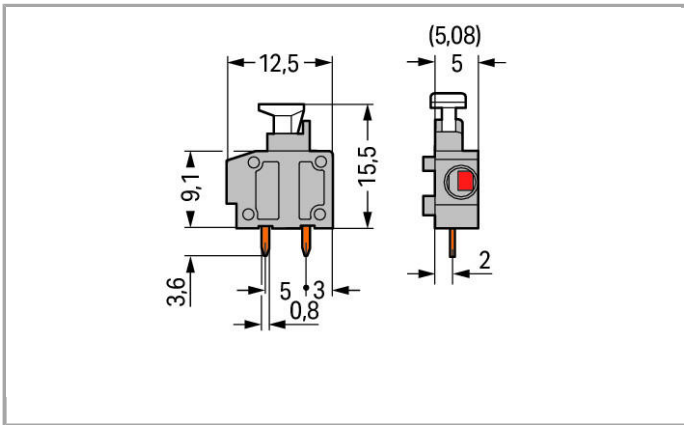

Artikelbeschreibung

- Einzelklemmen mit Drückern zur Konfektionierung individueller Klemmenleisten
- Eindräftige Leiter und feindräftige Leiter mit Aderendhülsen direkt steckbar
- Komfortable Drückerbetätigung für das Anschließen von feindräftigen Leitern und das Lösen von Leiter
- Einstellung zwischen den beiden Rastermaßen durch Zusammendrücken oder Auseinanderziehen der Klemmenleisten

Weitere Varianten können über den WAGO Vertrieb angefragt oder ggfs. unter <https://configurator.wago.com> konfiguriert werden: Andere Farben

Daten

Elektrische Daten

Bemessungsdaten gemäß IEC/EN 60664-1

Bemessungsspannung (III / 3)	250 V
Bemessungsstoßspannung (III / 3)	4 kV
Bemessungsspannung (III / 2)	320 V
Bemessungsstoßspannung (III / 2)	4 kV
Bemessungsspannung (II / 2)	630 V
Bemessungsstoßspannung (II / 2)	4 kV
Bemessungsstrom	17.5 A
Legende Bemessungsdaten	(III / 2) ≙ Überspannungskategorie III / Verschmutzungsgrad 2

Bemessungsdaten gemäß UL 1059

Bemessungsspannung UL (Use Group B)	300 V
Bemessungsstrom UL (Use Group B)	10 A
Bemessungsspannung UL (Use Group D)	300 V
Bemessungsstrom UL (Use Group D)	10 A

Bemessungsdaten gemäß CSA

Bemessungsspannung CSA (Use Group B)	300 V
Bemessungsstrom CSA (Use Group B)	15 A

Anschlussdaten

Anschluss technik	Push-in CAGE CLAMP®
Betätigungsart	Drücker
Eindrähtiger Leiter	0,2 ... 1,5 mm ² / 20 ... 14 AWG
Feindrähtiger Leiter	0,75 ... 1,5 mm ² / 20 ... 14 AWG
Feindrähtiger Leiter; mit Aderendhülse mit Kunststoffkragen	0,25 ... 1 mm ²
Feindrähtiger Leiter; mit Aderendhülse ohne Kunststoffkragen	0,25 ... 1 mm ²
Abisolierlänge	9 ... 10 mm / 0.35 ... 0.39 inch
Leiteranschlussrichtung zur Leiterplatte	0°
Polzahl	1
Gesamte Anzahl der Klemmstellen	1
Gesamte Anzahl der Potentiale	1
Anzahl Anschlusstypen	1
Anzahl der Ebenen	1

Geometrische Daten

Rastermaß	5/5,08 mm / 0.197/0.2 inch
Breite	6,5 mm / 0.256 inch
Höhe	19,1 mm / 0.752 inch
Höhe ab Oberfläche	15,5 mm / 0.61 inch
Tiefe	12,5 mm / 0.492 inch
Lötstiftlänge	3.6 mm
Lötstiftabmessungen	0,4 x 0,8 mm
Bohrlochdurchmesser mit Toleranz	1 ^(+ 0,1) mm

Leiterplattenkontaktierung

Leiterplattenkontaktierung	THT
Lötstifanordnung	innerhalb der Klemme in Reihe
Anzahl der Lötstifte pro Potential	2

Werkstoffdaten

Farbe	hellgrün
Isolierstoffgruppe	I
Isolierwerkstoff	Polyamid 66 (PA 66)

Brennbarkeitsklasse gemäß UL 94	V0
Klemmfederwerkstoff	Chrom-Nickel-Federstahl (CrNi)
Kontaktwerkstoff	Elektrolytkupfer (Ecu)
Kontaktoberfläche	verzinkt
Brandlast	0.014 MJ
Gewicht	0.742 g

Umgebungsbedingungen





Grenztemperaturbereich	-60 ... +105 °C
------------------------	-----------------

Kaufmännische Daten

Ursprungsland	CH
GTIN	4044918832496
Zolltarifnummer	85369010000
Produktgruppe	4 (GDS- und Durchführungsklemmen)
eCl@ss 9.0	27-44-04-01
eCl@ss 8.0	27-44-04-01
ETIM 6.0	EC002643
ETIM 5.0	EC002643

Zulassungen / Zertifikate

Länderspezifische Zulassungen

Logo	Zulassung	Zertifikatsname
	CCA DEKRA Certification B.V.	NTR NL-7144
	CCA DEKRA Certification B.V.	2149549.02
	CCA DEKRA Certification B.V.	NTR NL 6919
	CCA DEKRA Certification B.V.	NTR NL-7625
	CSA DEKRA Certification B.V.	1673956



VDE
VDE Prüf- und Zertifizierungsinstitut

40029328

Schiff Zulassungen



Logo	Zulassung	Zertifikatsname
	DNV GL Det Norske Veritas, Germanischer Lloyd	TAE000016Z

Passende Produkte









Allgemeines Zubehör

	Art-Nr.: 235-701 Rasterzwischenstück; zur Verdoppelung des Rastermaßes	www.wago.com/235-701
--	--	--

Werkzeug

	Art-Nr.: 210-657 Betätigungswerkzeug mit teilisoliertem Schaft; Klinge (3,5 x 0,5) mm; kurz	www.wago.com/210-657
	Art-Nr.: 210-720 Betätigungswerkzeug mit teilisoliertem Schaft; Typ 2, Klinge (3,5 x 0,5) mm	www.wago.com/210-720

Abschlussplatte

	Art-Nr.: 235-100 Abschlussplatte; anrastbar; 1 mm dick	www.wago.com/235-100
	Art-Nr.: 235-200 Abschlussplatte; anrastbar; 1 mm dick	www.wago.com/235-200
	Art-Nr.: 235-300 Abschlussplatte; anrastbar; 1 mm dick	www.wago.com/235-300
	Art-Nr.: 235-400 Abschlussplatte; anrastbar; 1 mm dick	www.wago.com/235-400
	Art-Nr.: 235-500 Abschlussplatte; anrastbar; 1 mm dick	www.wago.com/235-500
	Art-Nr.: 235-550 Abschlussplatte; anrastbar; 1 mm dick	www.wago.com/235-550
	Art-Nr.: 235-600 Abschlussplatte; anrastbar; 1 mm dick	www.wago.com/235-600
	Art-Nr.: 235-650 Abschlussplatte; anrastbar; 1 mm dick	www.wago.com/235-650
	Art-Nr.: 235-700 Abschlussplatte; anrastbar; 1 mm dick	www.wago.com/235-700

	Art-Nr.: 235-800 Abschlussplatte; anrastbar; 1 mm dick	www.wago.com/235-800
--	--	--

	Art-Nr.: 235-850 Abschlussplatte; anrastbar; 1 mm dick	www.wago.com/235-850
--	--	--

Beschriftungsmaterial

	Art-Nr.: 210-332/500-202 Beschriftungsstreifen; als Bogen DIN A4; bedruckt; 1-16 (160x); Streifenhöhe 3 mm; Streifenlänge 182 mm; Aufdruck waagrecht; Selbstklebend	www.wago.com/210-332/500-202
--	---	--

	Art-Nr.: 210-332/500-204 Beschriftungsstreifen; als Bogen DIN A4; bedruckt; 17-32 (160x); Streifenhöhe 3 mm; Streifenlänge 182 mm; Aufdruck waagrecht; Selbstklebend	www.wago.com/210-332/500-204
--	--	--

	Art-Nr.: 210-332/500-205 Beschriftungsstreifen; als Bogen DIN A4; bedruckt; 1-32 (80x); Streifenhöhe 3 mm; Streifenlänge 182 mm; Aufdruck waagrecht; Selbstklebend	www.wago.com/210-332/500-205
--	--	--

	Art-Nr.: 210-332/500-206 Beschriftungsstreifen; als Bogen DIN A4; bedruckt; 33-48 (160x); Streifenhöhe 3 mm; Streifenlänge 182 mm; Aufdruck waagrecht; Selbstklebend	www.wago.com/210-332/500-206
--	--	--

Aderendhülse

	Art-Nr.: 216-101 Aderendhülse; Hülse für 0,5 mm ² / AWG 22; ohne Kunststoffkragen; galvanisch verzinkt	www.wago.com/216-101
---	---	--

	Art-Nr.: 216-102 Aderendhülse; Hülse für 0,75 mm ² / AWG 20; ohne Kunststoffkragen; galvanisch verzinkt	www.wago.com/216-102
--	--	--

	Art-Nr.: 216-103 Aderendhülse; Hülse für 1 mm ² / AWG 18; ohne Kunststoffkragen; galvanisch verzinkt	www.wago.com/216-103
--	---	--

	Art-Nr.: 216-121 Aderendhülse; Hülse für 0,5 mm ² / AWG 22; ohne Kunststoffkragen; galvanisch verzinkt	www.wago.com/216-121
--	---	--

	Art-Nr.: 216-122 Aderendhülse; Hülse für 0,75 mm ² / AWG 20; ohne Kunststoffkragen; galvanisch verzinkt	www.wago.com/216-122
--	--	--

	Art-Nr.: 216-123 Aderendhülse; Hülse für 1 mm ² / AWG 18; ohne Kunststoffkragen; galvanisch verzinkt	www.wago.com/216-123
--	---	--



















	Art-Nr.: 216-131 Aderendhülse; Hülse für 0,25 mm ² / AWG 24; ohne Kunststoffkragen; galvanisch verzinkt	www.wago.com/216-131
--	--	--

	Art-Nr.: 216-132 Aderendhülse; Hülse für 0,34 mm ² / AWG 24; ohne Kunststoffkragen; galvanisch verzinkt	www.wago.com/216-132
--	--	--

	Art-Nr.: 216-141 Aderendhülse; Hülse für 0,5 mm ² / AWG 22; ohne Kunststoffkragen; galvanisch verzinkt; Elektrolytkupfer; gasdicht aufgecrimpt; gemäß DIN 46228, Teil 1/08.92	www.wago.com/216-141
--	--	--

	Art-Nr.: 216-142 Aderendhülse; Hülse für 0,75 mm ² / AWG 20; ohne Kunststoffkragen; galvanisch verzinkt; Elektrolytkupfer; gasdicht aufgecrimpt; gemäß DIN 46228, Teil 1/08.92	www.wago.com/216-142
--	---	--

	Art-Nr.: 216-143 Aderendhülse; Hülse für 1 mm ² / AWG 18; ohne Kunststoffkragen; galvanisch verzinkt; Elektrolytkupfer;	www.wago.com/216-143
--	--	--

	gasdicht aufgecrimpt; gemäß DIN 46228, Teil 1/08.92	
	Art-Nr.: 216-151 Aderendhülse; Hülse für 0,25 mm ² / AWG 24; ohne Kunststoffkragen; galvanisch verzinkt	www.wago.com/216-151
	Art-Nr.: 216-152 Aderendhülse; Hülse für 0,34 mm ² / AWG 24; ohne Kunststoffkragen; galvanisch verzinkt	www.wago.com/216-152
	Art-Nr.: 216-201 Aderendhülse; Hülse für 0,5 mm ² / AWG 22; mit Kunststoffkragen; galvanisch verzinkt	www.wago.com/216-201
	Art-Nr.: 216-202 Aderendhülse; Hülse für 0,75 mm ² / AWG 20; mit Kunststoffkragen; galvanisch verzinkt	www.wago.com/216-202
	Art-Nr.: 216-203 Aderendhülse; Hülse für 1 mm ² / AWG 18; mit Kunststoffkragen; galvanisch verzinkt	www.wago.com/216-203
	Art-Nr.: 216-221 Aderendhülse; Hülse für 0,5 mm ² / AWG 22; mit Kunststoffkragen; galvanisch verzinkt	www.wago.com/216-221
	Art-Nr.: 216-222 Aderendhülse; Hülse für 0,75 mm ² / AWG 20; mit Kunststoffkragen; galvanisch verzinkt	www.wago.com/216-222
	Art-Nr.: 216-223 Aderendhülse; Hülse für 1 mm ² / AWG 18; mit Kunststoffkragen; galvanisch verzinkt	www.wago.com/216-223
	Art-Nr.: 216-224 Aderendhülse; Hülse für 1,5 mm ² / AWG 16; mit Kunststoffkragen; galvanisch verzinkt	www.wago.com/216-224
	Art-Nr.: 216-241 Aderendhülse; Hülse für 0,5 mm ² / AWG 22; mit Kunststoffkragen; galvanisch verzinkt; Elektrolytkupfer; gasdicht aufgecrimpt; gemäß DIN 46228, Teil 4/09.90	www.wago.com/216-241
	Art-Nr.: 216-242 Aderendhülse; Hülse für 0,75 mm ² / AWG 20; mit Kunststoffkragen; galvanisch verzinkt; Elektrolytkupfer; gasdicht aufgecrimpt; gemäß DIN 46228, Teil 4/09.90	www.wago.com/216-242
	Art-Nr.: 216-243 Aderendhülse; Hülse für 1 mm ² / AWG 18; mit Kunststoffkragen; galvanisch verzinkt; Elektrolytkupfer; gasdicht aufgecrimpt; gemäß DIN 46228, Teil 4/09.90	www.wago.com/216-243
	Art-Nr.: 216-262 Aderendhülse; Hülse für 0,75 mm ² / AWG 20; mit Kunststoffkragen; galvanisch verzinkt; Elektrolytkupfer; gasdicht aufgecrimpt; gemäß DIN 46228, Teil 4/09.90	www.wago.com/216-262
	Art-Nr.: 216-263 Aderendhülse; Hülse für 1 mm ² / AWG 18; mit Kunststoffkragen; galvanisch verzinkt; Elektrolytkupfer; gasdicht aufgecrimpt; gemäß DIN 46228, Teil 4/09.90	www.wago.com/216-263
	Art-Nr.: 216-301 Aderendhülse; Hülse für 0,25 mm ² / AWG 24; mit Kunststoffkragen; galvanisch verzinkt	www.wago.com/216-301
	Art-Nr.: 216-302 Aderendhülse; Hülse für 0,34 mm ² / AWG 24; mit Kunststoffkragen; galvanisch verzinkt	www.wago.com/216-302
	Art-Nr.: 216-321 Aderendhülse; Hülse für 0,25 mm ² / AWG 24; mit Kunststoffkragen; galvanisch verzinkt	www.wago.com/216-321
	Art-Nr.: 216-322 Aderendhülse; Hülse für 0,34 mm ² / AWG 24; mit Kunststoffkragen; galvanisch verzinkt	www.wago.com/216-322



Downloads

smartDATA

Leiterplatten Bibliotheken

EAGLE Bibliothek für WAGO-Leiterplattenklemmen Kompatibel ab EAGLE PCB Design Software Version 6.x	2.1 Nov 17, 2017	ZIP 23,9 MB	Download
TARGET Bibliothek für WAGO-Leiterplattenklemmen Kompatibel ab TARGET PCB Design Software Version 17.x	1.1.0 Oct 6, 2014	ZIP 27,1 MB	Download
DesignSpark Bibliothek für WAGO-Leiterplattenklemmen Kompatibel ab DesignSpark PCB Version 4.x	2.1 Oct 6, 2014	ZIP 22,5 MB	Download

CAD Daten

3D Download 235-747/331-000	URL	Download
-----------------------------	-----	----------

Änderungen vorbehalten.

WAGO Kontakttechnik GmbH & Co. KG
Hansastr. 27
32423 Minden
Telefon: +49571 887-0
E-Mail: info.de@wago.com | Web: www.wago.com

Haben Sie Fragen zu unseren Produkten?
Wir stehen Ihnen telefonisch unter +49 (571) 887-44222 gern zur
Verfügung.