

Artikel-Nr.: 732060

Bez.: Mini-DIN-Kupplung, 3-polig

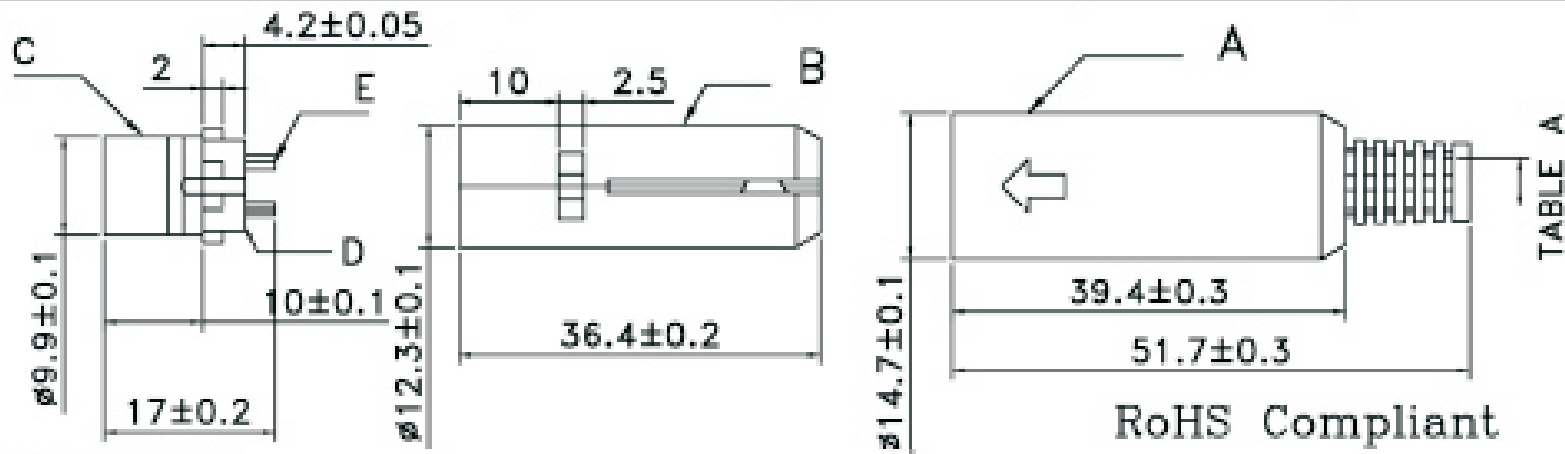
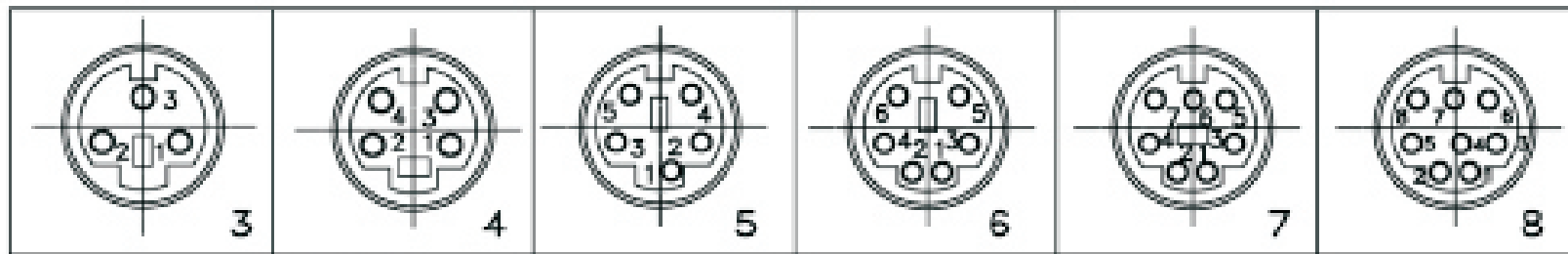

MATERIALS:

- A. BOOT: PE + 2L
- B. MIDDLE HOOD: HIPS (PH-88)
- C. METAL SHELL: COPPER NICKEL PLATED
- D. INSULATOR: NYLON 6 + G.F.
- E. PIN CONTACT: BRASS SILVER PLATED

SPECIFICATIONS:

- 1. RATION: 100V AC 1A MAX or 12V DC 2A MAX.
- 2. INSULATION RESISTANCE: 50M OHM MIN at 250V DC.
- 3. DIELECTRIC STRENGTH: 250 V AC / 1 MINUTE.
- 4. CONTACT RESISTANCE: 30M OHM MAX.
- 5. INSERTION FORCE: 4.5KG MAX.
- 6. WITHDRAWAL FORCE: 0.8KG ~ 3KG.
- 7. OPERATING TEMPERATURE: -20°C ~ 105°C

○	5.0# BACK SHELL (STANDARD)
○	COVER DIM.

TABLE A

www.bkl-electronic.de

Technische Änderungen vorbehalten. Ausführungen können variieren. Sollten Sie ein Muster benötigen kontaktieren Sie uns bitte.

BKL-ELECTRONIC Kreimendahl GmbH • Märkenstück 14 • 58509 Lüdenscheid
Tel: +49 (0)2351-3621-0 • Fax: +49 (0)2351-3621-29 • info@bkl-electronic.de

