

Artikel-Nr.: 734209

Bez.: Mini-DIN-Einbaubuchse mit angecrimptem Kabel AWG 26, Kabellänge ca. 100mm, 6-polig

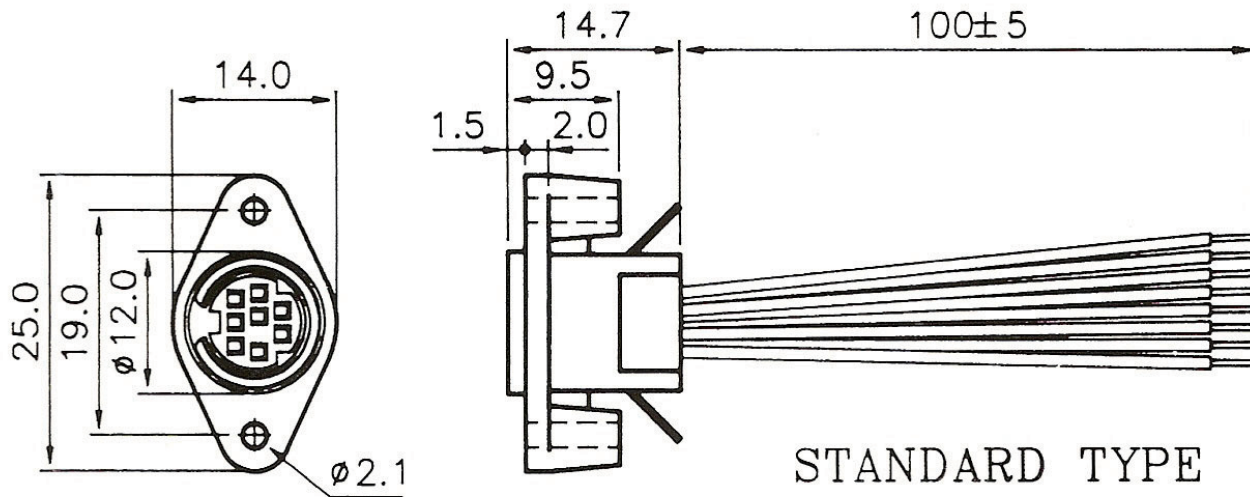

Rating: 100V AC 1A MAX or
12V DC 2A MAX

Insulation Resistance: 50MΩ min. at 250V DC

Dielectric Strength: 250V AC/1minute

Contact Resistance: 30mΩ MAX

Insertion Force: 4.5kg MAX

Withdrawal Force: 0.9kg~3kg

Wire: AWG#26

All materials must be RoHS compliant.

ARRANGEMENT OF CONTACTS						
NO. OF CONTACTS		3	4	5	6	8
WIRE COLOR	1	BLACK	BLACK	BROWN	BROWN	BROWN
	2	GREEN	GREEN	BLACK	WHITE	WHITE
	3	ORANGE	YELLOW	GREEN	BLACK	BLACK
	4	---	RED	YELLOW	GREEN	BLUE
	5	---	---	RED	YELLOW	GREEN
	6	---	---	---	RED	YELLOW
	7	---	---	---	---	ORANGE
	8	---	---	---	---	RED

www.bkl-electronic.de

Technische Änderungen vorbehalten. Ausführungen können variieren. Sollten Sie ein Muster benötigen kontaktieren Sie uns bitte.

BKL-ELECTRONIC Kreimendahl GmbH • Märkenstück 14 • 58509 Lüdenscheid

Tel: +49 (0)2351-3621-0 • Fax: +49 (0)2351-3621-29 • info@bkl-electronic.de

