

Artikel-Nr.: 735338

Bez.: DIN-Stecker, 3-polig, mit Verriegelung

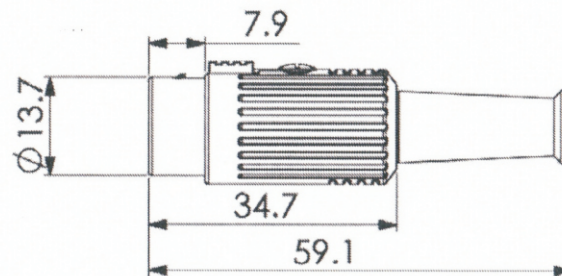
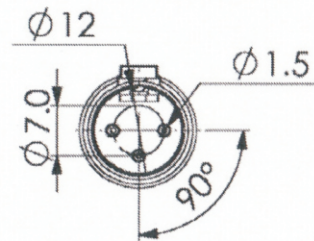
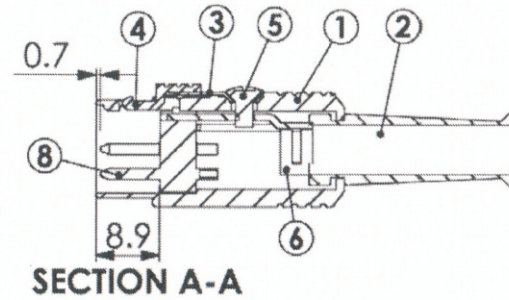
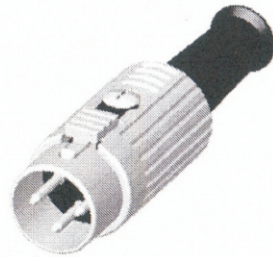

8	Terminals	Brass	Silver Ptd.	3
7	3P Housing	ABS		1
6	"T" Holder	Steel	Nickel Ptd.	1
5	Setscrew	Steel	Nickel Ptd.	1
4	Hook Button	Zn Alloy	Nickel Ptd.	1
3	Leaf Spring	Steel	Thermal Treatment	1
2	Strain Boot	PVC		1
1	Shield Cover	Zn Alloy	Nickel Ptd.	1
No.	Description	Material	Treat	Q'ty

Specifications

rating : 100V AC 4A MAX
 contact resistance : pins-30mΩ MAX; shell-50mΩ MAX
 insulation resistance : MIN 100 MEGΩ @500V DC
 voltage withstand : 250V AC R.M.S. for 1 minute

www.bkl-electronic.de

Technische Änderungen vorbehalten. Ausführungen können variieren. Sollten Sie ein Muster benötigen kontaktieren Sie uns bitte.

BKL-ELECTRONIC Kreimendahl GmbH • Märkenstück 14 • 58509 Lüdenscheid
 Tel: +49 (0)2351-3621-0 • Fax: +49 (0)2351-3621-29 • info@bkl-electronic.de

