

Artikel-Nr.: 738372

Bez.: Mini-DIN-Einbaubuchse mit angecrimptem Kabel AWG 26, Kabellänge ca. 100mm, 8-polig

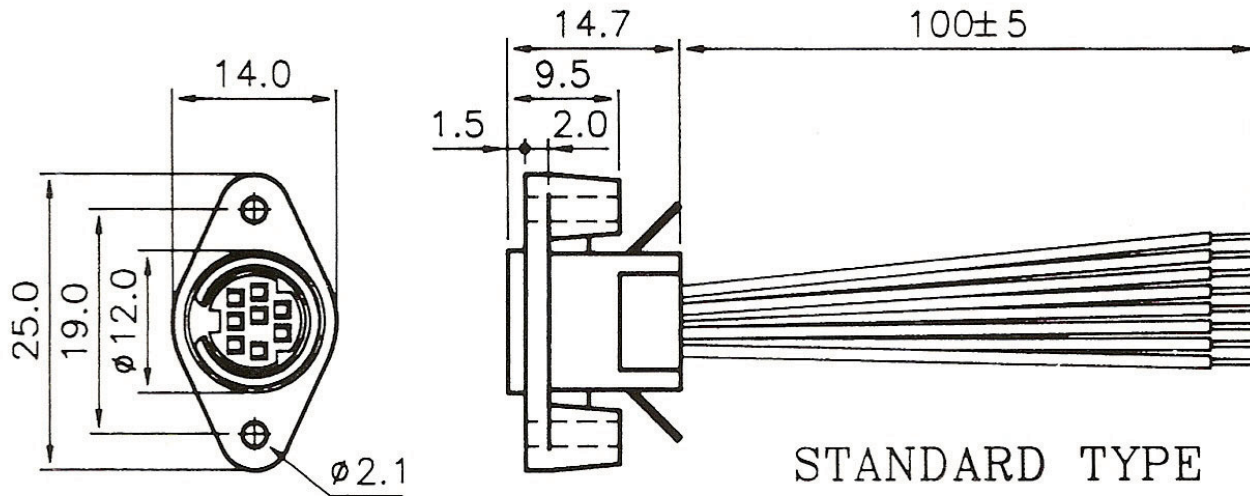

**Rating:** 100V AC 1A MAX or  
12V DC 2A MAX

**Insulation Resistance:** 50MΩ min. at 250V DC

**Dielectric Strength:** 250V AC/1minute

**Contact Resistance:** 30mΩ MAX

**Insertion Force:** 4.5kg MAX

**Withdrawal Force:** 0.9kg~3kg

**Wire:** AWG#26

**All materials must be RoHS compliant.**

ARRANGEMENT OF CONTACTS						
NO. OF CONTACTS		3	4	5	6	8
WIRE COLOR	1	BLACK	BLACK	BROWN	BROWN	BROWN
	2	GREEN	GREEN	BLACK	WHITE	WHITE
	3	ORANGE	YELLOW	GREEN	BLACK	BLACK
	4	---	RED	YELLOW	GREEN	BLUE
	5	---	---	RED	YELLOW	GREEN
	6	---	---	---	RED	YELLOW
	7	---	---	---	---	ORANGE
	8	---	---	---	---	RED

[www.bkl-electronic.de](http://www.bkl-electronic.de)

Technische Änderungen vorbehalten. Ausführungen können variieren. Sollten Sie ein Muster benötigen kontaktieren Sie uns bitte.

BKL-ELECTRONIC Kreimendahl GmbH • Märkenstück 14 • 58509 Lüdenscheid

Tel: +49 (0)2351-3621-0 • Fax: +49 (0)2351-3621-29 • [info@bkl-electronic.de](mailto:info@bkl-electronic.de)

