

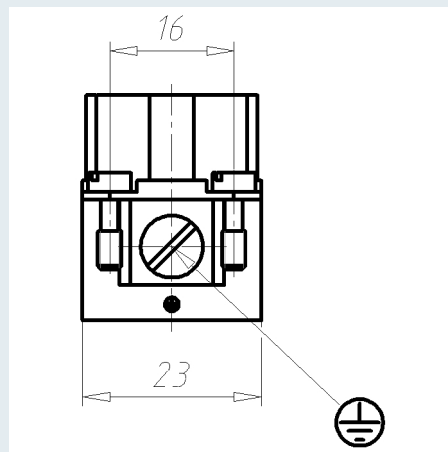

Einsätze EPIC® H-A 16

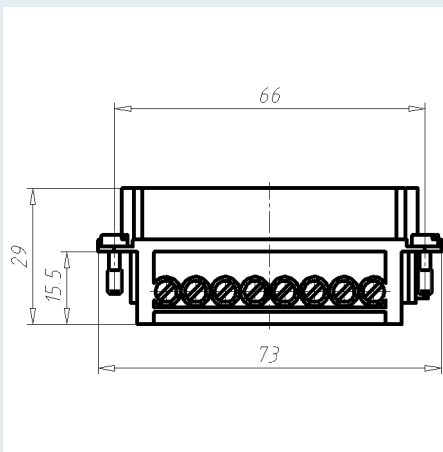

M

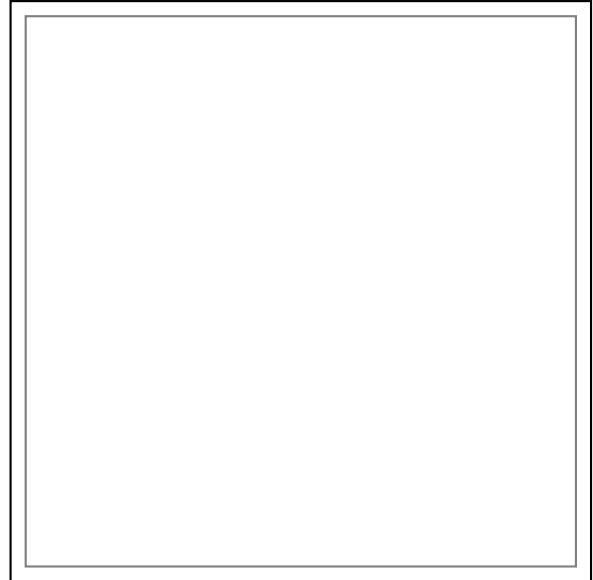
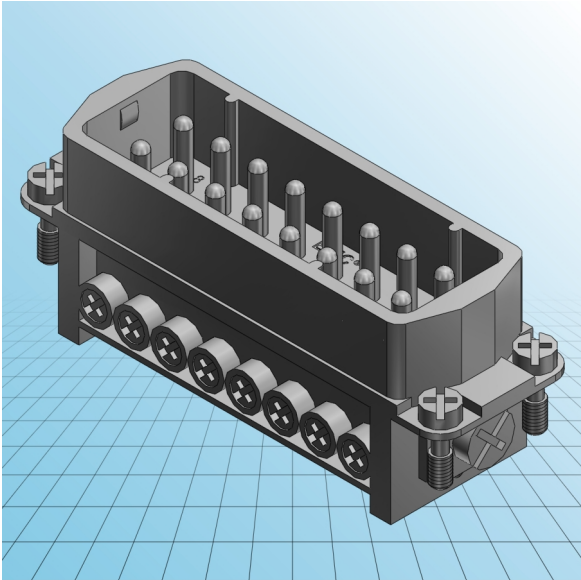
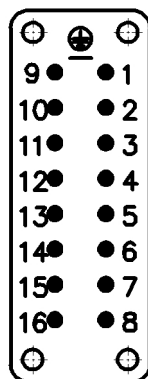



Einsätze EPIC® H-A 16

IDNR (Identnummer)	
ATN (Artikelnummer)	10530000
MD (Materialbezeichnung)	EPIC H-A 16 SS DR PH1
WG (Gewicht / g)	67.9
VPE (Verpackung [Stück])	5