

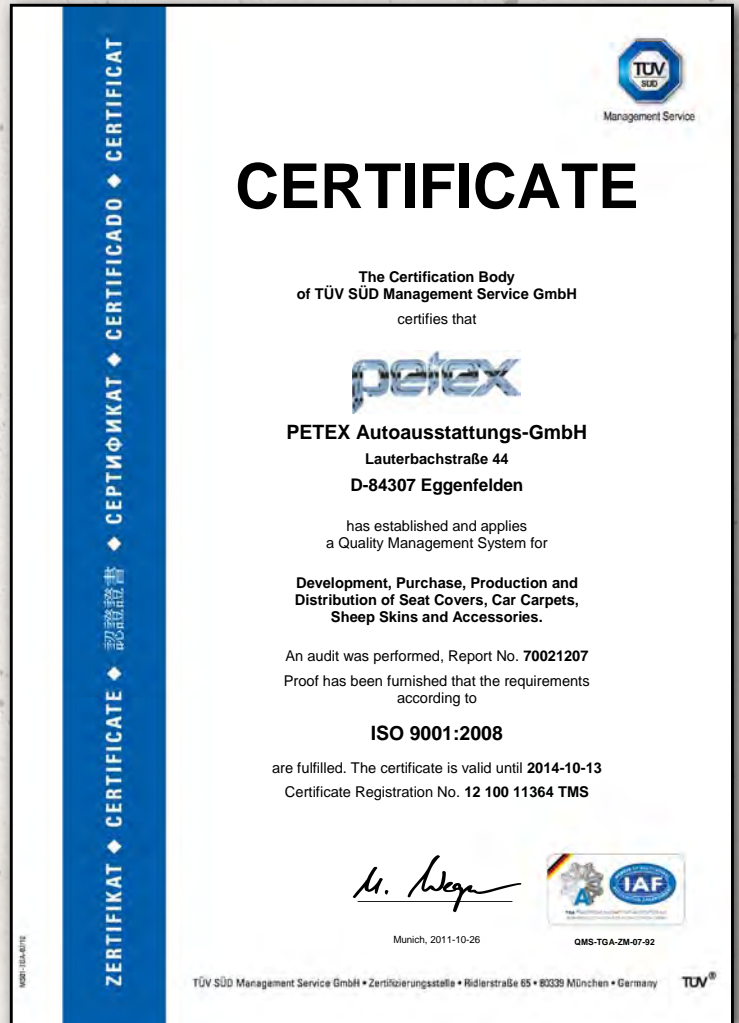

petex

...die starke Autoausstattung

2014 / 2015



Seit 1981 Jahren ist die Firma PETEX bekannt als zuverlässiger Lieferant von Qualitäts-Autoausstattung und -zubehör. Neben den Maßsitzbezügen und Gummimatten stammen alle textilen Passformteppiche und auch der überwiegende Teil unserer Universal-Autoteppiche aus unserer **eigenen Produktion**. Produkte welche nicht unserer eigenen Produktion entstammen werden jedoch nach unseren Vorgaben mit dem gleichen Qualitätsanspruch hergestellt um unser Sortiment entsprechend zu ergänzen. Unser nach ISO 9001:2008 zertifiziertes Qualitätsmanagementsystem sichert hierbei einen gleichbleibend qualitativ hohen Herstellungs- und Überwachungsprozess in allen Stadien der Produktion.

In den letzten Jahren haben wir unser Kernsortiment um einige Produktgruppen wie Sicherheitszubehör, Radzierblenden, Eiskratzer und Schneebesen oder auch dem ein oder anderen Werkstattartikel erweitert und ergänzt, um Ihnen ein möglichst umfassendes Sortiment bieten zu können. Auch die neue PETEX-Kollektion 2014/2015 hat wieder für jeden Geschmack etwas zu bieten.



Since 1981, PETEX has been known as reliable source for quality car-equipment and accessories. Other than the tailor-made seat-covers and rubber-mats, all textile customised-carpets, as well as most of the universal car-mats originate from our **own production**. Products which do not originate from our own production are also produced according to our specifications and under the same quality requirements to complete our assortment accordingly. Our certified quality management system, according to ISO 9001:2008, is ensuring a consistent production and monitoring process throughout all stages of the production.

During the past years, we have been adding some additional product categories, such as safety-accessories, wheel-covers, ice-scrappers and snow-brushes, but also some workshop-items, to our core product range to be able to offer you a preferably complete assortment. Again the new PETEX-collection 2014/1015 is offering something for everybodys needs.

BILDER UNSERER PRODUKTION / PICTURES OF OUR PRODUCTION

Produktion Autoteppiche / Production of car carpets



Stanze / punching machine



Cutter



Bandsäge / band saw



HF-Schweiße / HF welding machine



Näherei Autoteppiche / car carpet sewing



Stickmaschine / embroidery machine

Produktion Sitzbezüge / Production of seat-covers



Cutter



Näherei Sitzbezüge / seat cover sewing



Airbag-Naht / Airbag seam

Produktion Gummimatten / Production of rubber-mats



Werkzeuglager / tools storage



Rohmischung / raw compound



Pressraum / pressing room

Presse / press



Presse / press



Mattenrohlinge / mat billets



Entgraten / trimming

Lager / warehouse



Rohwarenlager / gray warehouse



Fertigwarenlager / warehousing

















Fertigwarenlager / warehousing

INHALTSVERZEICHNIS / TABLE OF CONTENT

Seite Page		
08 - 27	Autoteppiche	Car carpets
28 - 30	Gummimatten Paßform	Rubbermats, customised
31	LKW-Schmutzfänger	Mud-flaps for trucks
32 - 37	Gummimatten Universal	Rubbermats, universal
38 - 39	Rechteckmatten Rechteck-Schalenmatten Stufenmatte	Rectangular mats Rectangular bucket mats Stair mats
40 - 42	Rillengummi	Grooved rubber
42	Antirutsch-Matte	Anti-slip mat
43	Schalenmatte Kofferraummatte	Trunk mats
46 - 67	Sitzbezüge First Class	Seat-covers, First Class
68 - 79	Sitzbezüge Business Class	Seat-covers, Business Class
80 - 115	Sitzbezüge Set Eco Class	Seat-covers, Eco Class
116 - 117	Sitzaufleger	Seat-cushions
118 - 119	Schutzbezüge	Protection seat-covers
120 - 125	Sicherheitszubehör	Safety accessories
126 - 129	Zubehör	Accessories
130 - 139	Taschenlampen	Flash lights
140 - 141	Batterien	Batteries
142 - 153	Radzierblenden	Wheel-covers
154 - 158	Eiskratzer & Schneebesen	Ice scrapers & snow brushes
159 - 162	Autoreinigung	Car cleaning
163 - 165	Schutzgaragen	Car protection covers

SYMBOLERKLÄRUNGEN / SYMBOL EXPLANATIONS

		
	Sitzbezug ist auch für Fahrzeuge mit Seitenairbag geeignet	seat-cover is also suitable for vehicles with sideairbag
	waschbar bis 30° C mit Feinwaschmittel	washable up to 30° C with mild detergent
	Lichtechtheit geprüft nach DIN 75202	Light fastness tested to DIN 75202
	Scheuerfestigkeit geprüft nach RAL-RG 439	scrub-firmness tested to RAL-RG 439
	Echtes Leder	genuine leather
	Überwachte Qualität	checked quality
	Schaumstoffkaschierung schwer entflammbar	flameproof foam-coating
	Inklusive Befestigungssystem	including fixing-system
	Echtes Lammfell	genuine sheep-skin
	„First Class“ Sitzbezug nach Maß lieferbar für PKW	„First Class“ customised seat-cover available for cars
	„First Class“ Sitzbezug nach Maß lieferbar für LKW	„First Class“ customised seat-cover available for trucks
	Lieferbar als Passform Autoteppich	available as fitted car-carpet
	Lieferbar als Universal Autoteppich	available as universal car-carpet



 Unsere vom Institut Hohenstein getesteten Wellness – Multitexmaterialien „Air-stream“ erlauben maximale Atmungsaktivität und Ventilation. Sie sorgen gleichzeitig für schnelleren Feuchtigkeitstransfer, rasche Lufttrocknung, verhindern Wärmestau und regeln das Gleichgewicht zwischen Wärmeentstehung und Wärmeverlust. Diese angenehme und effektive Wellness Funktion erhöht den klimatischen Sitzkomfort und bewirkt eine längere Konzentration beim Autofahren.

 The Hohenstein Institutes tested our „Air-stream“ multilayer composite materials, which are exceptionally breathable and provide a remarkably good ventilation. At the same time, it ensures a faster transfer of moisture and is fast drying. The composite materials also avoid heat accumulation and regulate the balance of the generation of heat and heat loss. This comfortable and effective function enhances the climatic sitting comfort and helps to create an elevated concentration while driving.

Veloursband / Velours binding



04 schwarz



02 graphit



18 grau

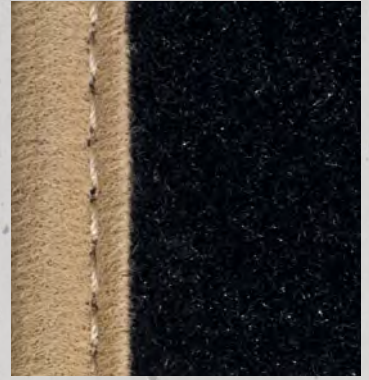

09 beige

Bi-Color-band / Bi-Color binding



05 blau



12 rot



13 grün



19 gelb

Webband / woven binding

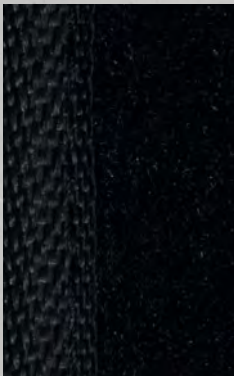

04 schwarz

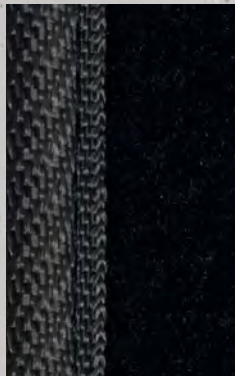

02 graphit



18 grau



09 beige



05 blau

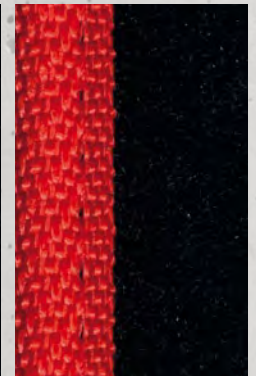

12 rot



Diese exklusive Bandeinfassung können Sie optional für die Qualitäten „Comet“ und „Saturn“ erhalten.

This exclusive binding is optionally available for our qualities „Comet“ and „Saturn“

Bandeinfassung

Textile bordering



Entscheiden Sie selbst ob Ihre Autoteppiche die Standardeinfassung beibehalten oder für Sie individuell mit einer dieser abgebildeten Varianten eingefasst werden sollen. Diese Möglichkeit bieten wir Ihnen gegen einen geringen Aufpreis für alle Autoteppich-Qualitäten.



Decide for yourself whether your textile car-mats should keep the standard bordering or should be bordered with one of these represented alternatives. For a moderate surcharge we offer this option for all carpet-qualities.



„Comet“ Art. 114

- Paßform-Autoteppich
- 5/64 Turf-Velours-Qualität
- 100% Polyamid
- Fasereinsatz ca. 800 g/m²
- Gesamtgewicht ca. 2.300 g/m²
- Supergrip-Rückenbeschichtung
- Hochwertige Bandeinfassung
- Ein Spitzenteppich unserer Kollektion
- Inklusive Befestigungssystem



„Comet“ Art. 114

- customised car-carpet
- 5/64 tuft-velvet-quality
- 100% polyamide
- fibre weight approx. 800 g/m²
- total weight approx. 2.300 g/m²
- supergrip-backing
- bordered with a high-quality tone-in-tone binding
- an absolute first-class product
- including fixing-system



AUTOTEPPICHE - CAR-CARPETS



09 beige

P



02 graphit



18 grau



Neu - New



„Luxus“ Art. 125

- Paßform-Autoteppich
- 1/10 Tuft, schimmernde Perl-Velours-Qualität
- 100% Polyamid
- Fasereinsatz ca. 600 g/m²
- Gesamtgewicht ca. 4.200 g/m²
- Textile Ton-in-Ton Bandeinfassung
- **Wasserundurchlässige Gummirückenbeschichtung in Rippenstruktur**
- Inklusive Befestigungssystem



„Luxus“ Art. 125

- customised car-carpet
- 1/10 Tuft, shimmery pearl-velours-quality
- 100 % polyamide
- fibre-weight approx. 600 g/m²
- total weight approx. 4.200 g/m²
- bordered with a tone-in-tone binding
- **waterproof, ribbed rubber-coating**
- including fixing-system



02 graphit



„Saturn“ Art. 104

- Paßform-Autoteppich
- 1/10 Tuft-Velours-Qualität
- 100% Polyamid
- Fasereinsatz ca. 450 g/m²
- Gesamtgewicht ca. 2.000 g/m²
- Textile Ton-in-Ton Velourband-Einfassung
- Supergrip-Rückenbeschichtung
- Inklusive Befestigungssystem



„Saturn“ Art. 104

- customised car-carpet
- 1/10 Tuft-Velours-quality
- 100% polyamide
- fibre-weight approx. 450 g/m²
- total weight approx. 2.000 g/m²
- bordered with a tone-in-tone binding
- supergrip backing
- including fixing-system



Besonders für Direktstick geeignet!
especially suitable for direct-embroidery

02 graphit



P



„Style“ Art. 131

- Paßform-Autoteppich
- 1/10 Tuftvelours,
100% Polypropylen
- Fasereinsatz ca. 750 g/m²
- Gesamtgewicht ca. 2.000 g/m²
- Neuartige Filzgrip-
Rückenbeschichtung
- Textile Ton-in-Ton Bandeinfassung
- Inklusive Befestigungssystem



„Style“ Art. 131

- customised car-carpet
- 1/10 tuftvelours,
100% polypropylene
- fibre weight approx. 750 g/m²
- total weight approx. 2.000 g/m²
- novel felt-grip backing
- bordered with a tone-in-tone
binding
- including fixing-system



02 graphit

AUTOTEPPICHE - CAR-CARPETS

**„Rex“ Art. 112**

- Paßform-Autoteppich
- Dilour-Qualität
- 100% Polypropylen
- Fasereinsatz ca. 550 g/m²
- Gesamtgewicht ca. 1.800 g/m²
- Mit Gummigranulat-Rückenbeschichtung
- Fahrermatte mit aufgeschweißtem Textilabsatzschoner
- Textile Ton-in-Ton Ketteinfassung
- Inklusive Befestigungssystem

**„Rex“ Art. 112**

- customised car-carpet
- dilour-quality
- 100% polypropylene
- fibre-weight approx. 550 g/m²
- total-weight approx. 1.800 g/m²
- granular rubber-coating
- driver's mat with textile heel-pad (high frequency welded)
- bordered with a textile tone-in-tone overcast seam
- including fixing-system



Bei Passform-Autoteppichen aus fertigungstechnischen Gründen Mindestabnahme pro Auftrag 20 Satz!

Due to considerations concerning our production the minimum order quantity for this quality is 20 set / order for customised car-carpets!

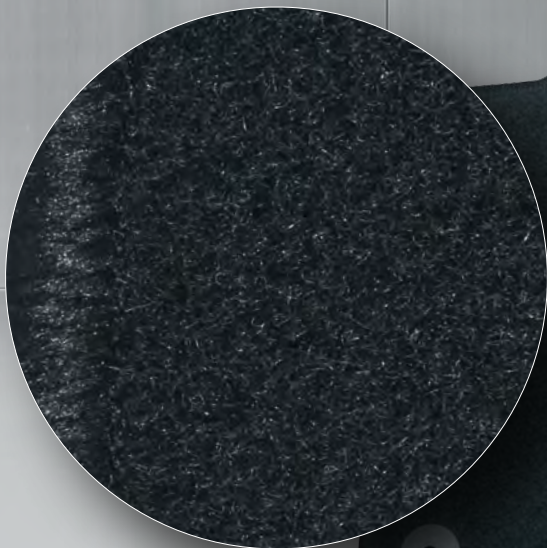

02 graphit





„Remo“ Art. 146

- Paßform-Autoteppich
- Feinrippe, 100% Polypropylen
- Fasereinsatz ca. 1.100 g/m²
- Gesamtgewicht ca. 2.200 g/m²
- PES-Schaum Rückenbeschichtung
- Textile Ton-in-Ton Bandeinfassung
- Inklusive Befestigungssystem



„Remo“ Art. 146

- customised car-carpet
- fine rib structure, 100% polypropylene
- fibre-weight approx. 1.100 g/m²
- total weight approx. 2.200 g/m²
- PES-foam coating
- bordered with a tone-in-tone binding
- including fixing-system



09 beige

AUTOTEPPICHE - CAR-CARPETS

03 silber

02 graphit

04 schwarz

12 rot



„Avus“ Art. 102

- Paßform- Autoteppich
- Dilour-Qualität, 100% Polyester
- Fasereinsatz ca. 570 g/m²
- Gesamtgewicht ca. 1700 g/m²
- NSF-Latex Rückenbeschichtung mit Sternprägung
- Mit textiler Ton-in-Ton Bandeinfassung
- Inklusive Befestigungssystem



„Avus“ Art. 102

- customised car carpet
- dilour-quality, 100% polyester
- fibre-weight approx. 570 g/m²
- total weight approx. 1700 g/m²
- NSF-Latex coating with stellar-embossing
- bordered with a textile tone-in-tone binding
- including fixing-system



Aus fertigungstechnischen Gründen Mindestabnahme pro Auftrag 20 Satz!

Due to considerations concerning our production the minimum order quantity for this quality is 20 set / order

Besonders für Direktstick geeignet!
especially suitable for direct-embroidery

petex

AUTOTEPPICHE - CAR-CARPETS

04 schwarz





„Sport“ Art. 145

- Paßform-Autoteppich
- Dilour-Qualität, 100% Polypropylen
- Fasereinsatz ca. 400 g/m²
- Gesamtgewicht ca. 1.600 g/m²
- Mit Gummigranulat-Rückenbeschichtung
- Fahrermatte mit aufgeschweißtem Textilabsatzschoner
- Textile Ton-in-Ton Ketteleinfassung
- Inklusive Befestigungssystem



„Sport“ Art. 145

- customised car-carpet
- dilour-quality, 100% polypropylene
- fibre-weight approx. 400 g/m²
- total-weight approx. 1.600 g/m²
- granular rubber-coating
- driver's mat with textile heel-pad (high frequency welded)
- bordered with a textile tone-in-tone overcast seam
- including fixing-system



**Aus fertigungstechnischen Gründen
Mindestabnahme pro Auftrag 20 Satz!**

**Due to considerations concerning our
production the minimum order quantity
for this quality is 20 set / order**



02 graphit



„Style“ Art. 131

- Universal-Autoteppich
- 1/10 Tuftvelours,
100% Polypropylen
- Fasereinsatz ca. 750 g/m²
- Gesamtgewicht ca. 2.000 g/m²
- Neuartige Filzgrip-
Rückenbeschichtung
- Textile Ton-in-Ton Bandeinfassung
- Inklusive Befestigungssystem



„Style“ Art. 131

- universal car-carpet
- 1/10 tuftvelours,
100% polypropylene
- fibre weight approx. 750 g/m²
- total weight approx. 2.000 g/m²
- novel felt-grip backing
- bordered with a tone-in-tone
binding
- including fixing-system



Art.-Nr.	Farbe	Größe	Einheit	VPE
13170102	graphit	2	Satz	8
13170202	graphit	3	Satz	8



02 graphit

AUTOTEPPICHE - CAR-CARPETS

**„Rex“ Art. 112**

- Universal-Autoteppich
- Dilour-Qualität
- 100% Polypropylen
- Fasereinsatz ca. 550 g/m²
- Gesamtgewicht ca. 1.800 g/m²
- Mit Gummigranulat-Rückenbeschichtung
- Fahrermatte mit aufgeschweißtem Textilabsatzschoner
- Textile Ton-in-Ton Ketteinfassung
- Inklusive Befestigungssystem

**„Rex“ Art. 112**

- universal car-carpet
- dilour-quality
- 100% polypropylene
- fibre-weight approx. 550 g/m²
- total-weight approx. 1.800 g/m²
- granular rubber-coating
- driver's mat with textile heel-pad (high frequency welded)
- bordered with a textile tone-in-tone overcast seam
- including fixing-system



Art.-Nr.	Farbe	Größe	Einheit	VPE
11270102	graphit	2	Satz	10
11270202	graphit	3	Satz	10

**02 graphit**



„Florida 3“ Art. 134

- Lieferbar als Universal-Autoteppich
- Dilour-Qualität
- 100% Polypropylen
- Gummigranulat-Rückenbeschichtung
- Mit textiler Ton-in-Ton Ketteinfassung
- Mit aufgeschweißtem Absatzschoner
- Inklusive Klett-Befestigungssystem



„Florida 3“ Art. 134

- available as universal car-carpet
- dilour-quality
- 100% polypropylene
- granular rubber coating
- bordered with tone-in-tone overcast seam
- driver's mat with textile heel-pad (high frequency welded)
- including velcro fixing-system



Art.-Nr.	Farbe	Größe	Einheit	VPE
13480004	schwarz	0	Satz	15

**Aus fertigungstechnischen Gründen
Mindestabnahme pro Auftrag 15 Satz!**

**Due to considerations concerning our
production the minimum order quantity
for this quality is 15 set / order**

AUTOTEPPICHE - CAR-CARPETS



04 schwarz

„Sopo“ Universal Art. 111



- Lieferbar als Universal-Autoteppich
- Strapazierfähige Doppelrippenstruktur
- 100% Polypropylen
- Mit Gummigranulat-Rückenbeschichtung
- Fahrermatte mit aufgeschweißtem Textilabsatzschoner
- Textile Ton-in-Ton Ketteinfassung
- Inklusive Befestigungssystem



„Sopo“ Art. 111

- available as universal car-carpet
- sturdy double-ribbed structure
- 100% polypropylene
- granular rubber-coating
- driver's mat with textile heel-pad (high frequency welded)
- bordered with a textile tone-in-tone overcast seam
- including fixing-system



Art.-Nr.	Farbe	Größe	Einheit	VPE
11170101	anthrazit	2	Satz	10
11170201	anthrazit	3	Satz	10



01 anthrazit



„Avus“ Art. 102

- Universal-Autoteppich
- Dilour-Qualität, 100% Polyester
- Fasereinsatz ca. 570 g/m²
- Gesamtgewicht ca. 1700 g/m²
- NSF-Latex Rückenbeschichtung mit Sternprägung
- Mit textiler Ton-in-Ton Bandeinfassung
- Inklusive Befestigungssystem



„Avus“ Art. 102

- universal car-carpet
- dilour-quality, 100% polyester
- fibre-weight approx. 570 g/m²
- total weight approx. 1700 g/m²
- NSF-Latex coating with stellar-embossing
- bordered with a textile tone-in-tone binding
- including fixing-system



Art.-Nr.	Farbe	Größe	Einheit	VPE
10270104	schwarz	2	Satz	10
10270204	schwarz	3	Satz	10



04 schwarz



AUTOTEPPICHE - CAR-CARPETS

**„Sport“** Art. 145

- Universal-Autoteppich
- Dilour-Qualität, 100% Polypropylen
- Fasereinsatz ca. 400 g/m²
- Gesamtgewicht ca. 1.600 g/m²
- Mit Gummigranulat-Rückenbeschichtung
- Fahrermatte mit aufgeschweißtem Textilabsatzschoner
- Textile Ton-in-Ton Ketteinfassung
- Inklusive Befestigungssystem

**„Sport“** Art. 145

- universal car-carpet
- dilour-quality, 100% polypropylene
- fibre-weight approx. 400 g/m²
- total-weight approx. 1.600 g/m²
- granular rubber-coating
- driver's mat with textile heel-pad (high frequency welded)
- bordered with a textile tone-in-tone overcast seam
- including fixing-system



Art.-Nr.	Farbe	Größe	Einheit	VPE
14570102	graphit	2	Satz	10
14570202	graphit	3	Satz	10



02 graphit



„Carbon“ Art. 113

- Universal-Autoteppich
- Dilour-Qualität
- 100% Polyester
- Mit textiler Bandeinfassung
- Sticklogo auf Fahrer- und Beifahrerseite
- Inklusive Klett-Befestigungssystem



„Carbon“ Art. 113

- universal car-carpet
- dilour-quality
- 100% polyester
- bordered with a woven binding
- embroidery-logo on both front mats
- including velcro fixing-system



Art.-Nr.	Farbe	Größe	Einheit	VPE
11380004	schwarz	0	Satz	10
11380005	blau	0	Satz	10
11380012	rot	0	Satz	10
11380018	grau	0	Satz	10



05 blau



04 schwarz



12 rot



18 grau

AUTOTEPPICHE - CAR-CARPETS

„Stickwerbung“

- Stickwerbung auf Autoteppichen, gestickt auf Velours und aufgeschweißt
- Je nach Wunsch bis zu 9 Farben möglich
- Preise für Stickwerbung auf Anfrage
- Aus Produktionstechnischen Gründen muss die Zahl der zu bestickenden Teppiche durch 10 teilbar sein.
- Lieferbar in folgenden Größen:
 220 x 60 mm
 150 x 45 mm
 124 x 35 mm
 100 x 70 mm



„Direkt-Stickwerbung“

- Stickwerbung **direkt auf Ihrem Autoteppich**, ohne Trägermaterial
- bis zu 9 Farben möglich
- Edle Optik
- Preise auf Anfrage
- Aus produktionstechnischen Gründen muss die Zahl der zu bestickenden Teppiche durch 8 teilbar sein.



WERBUNG - ADVERTISING

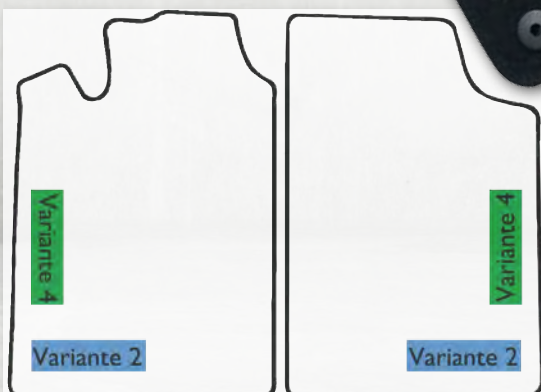

Mögliche Positionen



Alle PETEX-Gummimatten der Produktgruppen „Gummimatten für PKW und Nutzfahrzeuge“ sowie „Türvorleger und Stufenmatten im Außenbereich“ wurden von der LGA QualiTest GmbH, entsprechend den Voraussetzungen des Zertifikats „LGA tested contamination“, erfolgreich hinsichtlich folgenden Anforderungen getestet:

- ✓ Formaldehyd-Emission nach VDA 275
- ✓ Geruch nach VDA 270
- ✓ Phthalate - Weichmacher
- ✓ Halogenierte Phosphorsäureester (Flammschutzmittel)
- ✓ Polyzyklische Aromatische Kohlenwasserstoffe (PAK)



Neben einem Qualitätsmanagementsystem, zertifiziert vom TÜV Rheinland nach ISO 9001, unterhält unser Produktionsstandort in der Tschechischen Republik, an welchem unsere Gummimatten produziert werden, auch ein Umweltmanagementsystem nach ISO 14001. Somit genügt auch dieser Standort höchsten Qualitätsansprüchen vom Einkauf der Rohware bis zur Lieferung des fertigen Produkts.



All PETEX-rubber-mats in the product lines of „rubber-mats for passenger cars and utility vehicles“ as well as „doormats and stairway mats to be used outside“ have been successfully tested by LGA QualiTest GmbH, according to the demands of the certificate „LGA tested contamination“ and meet the following requirements:

- ✓ formaldehyde-emission according to VDA 275
- ✓ smell according to VDA 270
- ✓ phthalate-softeners
- ✓ halogenated phosphoric acid ester (flame resistant)
- ✓ polycyclic aromatic hydrocarbons (PAH)



In addition to a quality management system, certified by TÜV Rheinland according to ISO 9001, our production site in Czech Republic, where our rubber-mats are being produced, also runs a environmental management system according to ISO 14001. Thus, also this production site comes up to highest quality demands, from the purchasing of the raw materials to the delivery of the delivery of the finished product.



„Passform“ - Gummimatte

- Passform für **vorne und hinten**
- Hoher Rand als Schmutzfänger
- Ohne PVC
- Schadstoffgeprüft
- Überwachte Qualität



„Customised“ rubbermat

- perfect fit for **front and rear**
- high edge as dirt trap
- without PVC
- checked for toxic substances
- audited quality



Für Fahrzeuge folgender Hersteller bieten wir Passform-Gummimatten in schwarz an:

Angaben bezüglich einzelner Modelle bzw. weiterer Hersteller entnehmen Sie bitte unserer Modelltabelle oder besuchen Sie unseren Internet-Auftritt!

Audi	BMW	Citroen
Dacia	Fiat	Ford
Honda	Hyundai	Kia
Mazda	Mercedes	Mitsubishi
Nissan	Opel	Peugeot
Renault	Seat	Škoda
Smart	Subaru	Toyota
Volkswagen	Volvo	

Verfügbare Fahrzeugtypen finden Sie in der separat beiliegenden Modelltabelle oder Online unter www.petex.net

Available vehicle types are to be found in the separately enclosed table of sizes or online at www.petex.net

Vorderseite / frontside



Rückseite / backside





**„Passform“
Gummimatte LKW**

- Hoher Rand als Schmutzfänger
- Ohne PVC
- schadstoffgeprüft
- Überwachte Qualität



**„Customised“
rubbermat for trucks**

- high edge as dirt trap
- without PVC
- checked for toxic substances
- audited quality

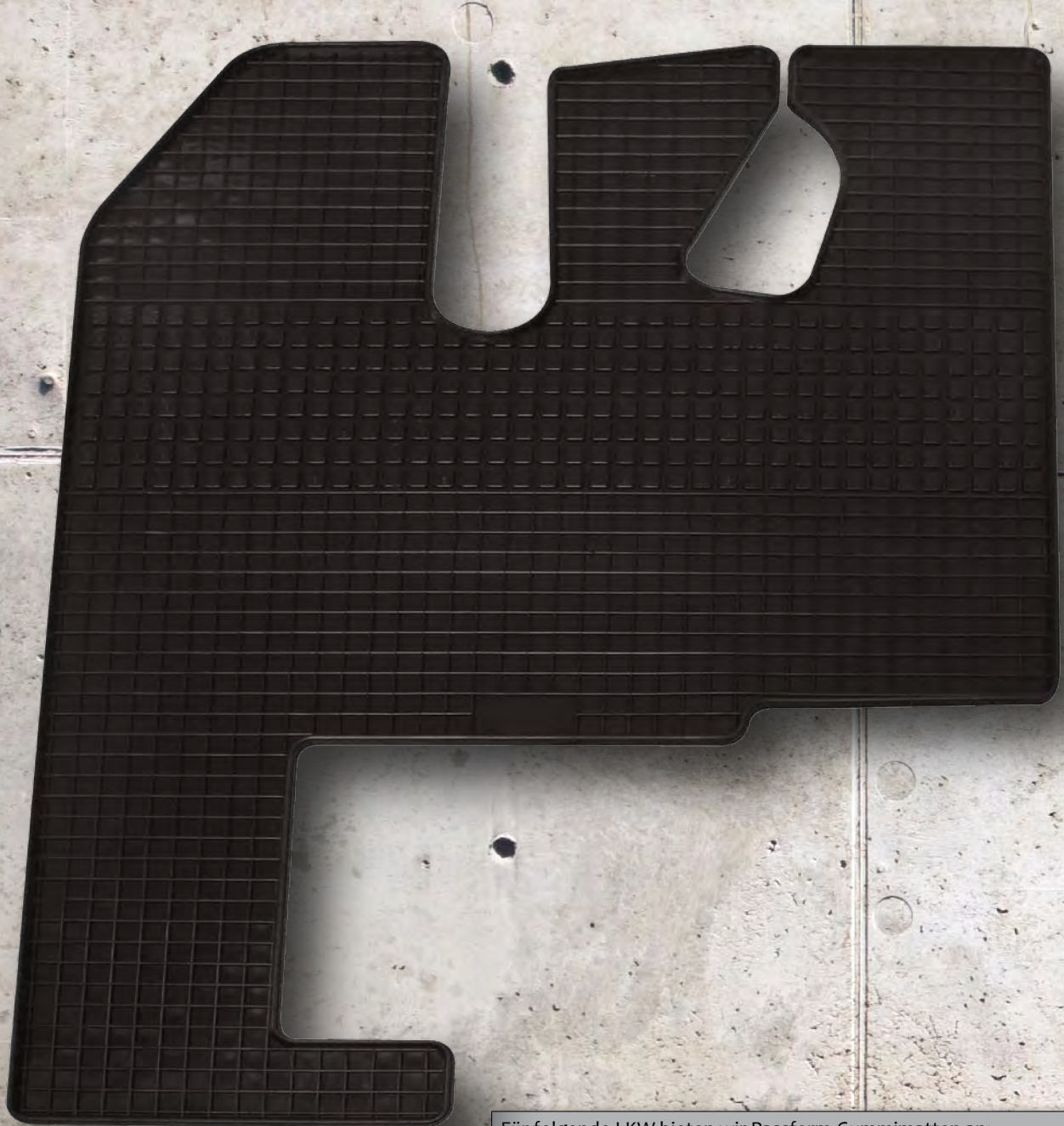

GUMMIMATTEN - RUBBERMATS

Für folgende LKW bieten wir Passform-Gummimatten an:

MAN		
99760	TGX vorne links	anthrazit
99761	TGX vorne rechts	anthrazit
99770	TGS vorne links	anthrazit
99771	TGS vorne rechts	anthrazit
RENAULT		
29860	Magnum ab 91 vorne links	schwarz
29870	Premium / Kerax / Lander / Midlum vorne links	schwarz

We offer customized-rubbermats for trucks listed above.



LKW - Schmutzfänger

- Extra schwere Gummi-Qualität
- Mit vormontierter Metalleiste
- Ohne PVC



Truck mud-flaps

- extra strong and heavy rubber-quality
- including pre-assembled metalstrip
- without PVC



Artikelnummer:	Lieferbare Größen / available sizes
SM040 410 003	400 x 300 mm
SM040 410 005	500 x 300 mm
SM040 410 012	500 x 400 mm
SM040 410 007	600 x 300 mm
SM040 410 008	650 x 300 mm
SM040 410 014	600 x 400 mm
SM040 410 015	650 x 400 mm
SM040 410 016	600 X 500 mm



**Auf Anfrage möglich:
Ihr Logo auf alle
Schmutzfänger.**

**Available upon request:
Your logo on all mud-flaps**



Alaska Art. 921

- Universal für vorne und hinten
- Ohne PVC
- schadstoffgeprüft
- Überwachte Qualität
- Durch die verschiedenen Rillen haben Sie die Möglichkeit, diese Gummimatte ihrem Fahrzeug entsprechend anzupassen.



Alaska Art. 921

- universal for front and rear
- without PVC
- checked for toxic substances
- audited quality
- Due to the numerous cutting-edges, this rubbermat can be easily adjusted to almost every vehicle.



Art.-Nr.	Farbe	Größe	Einheit	VPE
92100	schwarz	0	Satz	6

individuell anpassbar - mit vorgeformten Schnittlinien

can be cut to size - with preformed cutting lines



GUMMIMATTEN - RUBBERMATS



„Cargo“ Art. 927

- 2-teilig auf Bügel
- ca. 4 cm hoher Rand
- Ohne PVC
- Schadstoffgeprüft
- Überwachte Qualität
- Durch die verschiedenen Rillen haben Sie die Möglichkeit, diese Gummimatte ihrem Fahrzeug entsprechend anzupassen.
- Hinterteile separat bestellbar



„Cargo“ Art. 927

- 2-piece on a hanger
- approx. 4 cm high border
- without PVC
- checked for toxic substances
- audited quality
- Due to the numerous cutting-edges, this rubbermat can be easily adjusted to almost every vehicle.
- rear parts separately orderable



Art.-Nr.	Farbe	Ausführung	Größe	Einheit	VPE
927990	schwarz	Vorderteile	Universal	Satz	8
927991	schwarz	Hinterteile	Universal	Satz	-

3D

individuell anpassbar - mit vorgeformten Schnittlinien
 can be cut to size - with preformed cutting lines





„Standard“ Art. 921

- Universal in 3 Größen
- Mit hohem Rand als Schmutzfänger
- 4-teilig auf Bügel
- Ohne PVC
- Schadstoffgeprüft
- Überwachte Qualität



„Standard“ Art. 921

- universal in 3 sizes
- high edge as dirt trap
- 4-piece on a hanger
- without PVC
- checked for toxic substances
- audited quality



Art.-Nr.	Farbe	Größe	Einheit	VPE
92120	schwarz	1	Satz	6
92130	schwarz	2	Satz	6
92140	schwarz	3	Satz	6



GUMMIMATTEN - RUBBERMATS



„Ultra“ Art. 999

- Lieferbar in 2 Größen
- Modernes Waben-Design
- Mit besonders hohem Rand als Schmutzfänger
- 4-teilig auf Bügel
- Ohne PVC
- Schadstoffgeprüft
- Überwachte Qualität
- Durch die verschiedenen Rillen haben Sie die Möglichkeit, diese Gummimatte ihrem Fahrzeug entsprechend anzupassen.



„Ultra“ Art. 999

- available in 2 sizes
- modern comb-design
- high edge as dirt trap
- 4-piece on a hanger
- without PVC
- checked for toxic substances
- audited quality
- Due to the numerous cutting-edges, this rubbermat can be easily adjusted to almost every vehicle.



Art.-Nr.	Farbe	Größe	Einheit	VPE
99920	schwarz	1	Satz	6
99930	schwarz	2	Satz	6



individuell anpassbar - mit vorgeformten Schnittlinien
can be cut to size - with preformed cutting lines



„Polar plus“ Art. 924

- Universal für vorne und hinten
- Mit textilem Absatzschoner
- Ohne PVC
- zuschneidbar
- Schadstoffgeprüft
- Überwachte Qualität



„Polar plus“ Art. 924

- universal size for front and rear
- with textile heel-pad
- without PVC
- adjustable
- checked for toxic substances
- audited quality



Art.-Nr.	Farbe	Größe	Einheit	VPE
92421	schwarz	1	Satz	7
92431	schwarz	2	Satz	7
92441	schwarz	3	Satz	7
92222	schwarz	Hinterteil	Stück	-

individuell anpassbar - mit vorgeformten Schnittlinien

can be cut to size - with preformed cutting lines



GUMMIMATTEN - RUBBERMATS



„Polar“ Art. 922

- Universal für vorne und hinten
- Ohne PVC
- zuschneidbar
- Schadstoffgeprüft
- Überwachte Qualität



„Polar“ Art. 922

- universal size for front and rear
- without PVC
- adjustable
- checked for toxic substances
- audited quality



Art.-Nr.	Farbe	Größe	Einheit	VPE
92221	schwarz	1	Satz	7
92231	schwarz	2	Satz	7
92241	schwarz	3	Satz	7
92222	schwarz	Hinterteil	Stück	-

individuell anpassbar - mit vorgeformten Schnittlinien
can be cut to size - with preformed cutting lines





„Eco“ Art. 925

- Universal in 3 Größen
- 4-teilig auf Bügel
- Ohne PVC
- Schadstoffgeprüft
- Überwachte Qualität



„Eco“ Art. 925

- universal in 3 sizes
- 4-piece on a hanger
- without PVC
- checked for toxic substances
- audited quality



Art.-Nr.	Farbe	Größe	Einheit	VPE
92520	schwarz	1	Satz	6
92530	schwarz	2	Satz	6
92540	schwarz	3	Satz	6



GUMMIMATTEN - RUBBERMATS



„Megafit“ Art. 926

- Universal für vorne und hinten
- Ohne PVC
- Schadstoffgeprüft
- Überwachte Qualität
- 4-teilig auf Bügel

Durch die verschiedenen Rillen haben Sie die Möglichkeit, diese Gummimatte ihrem Fahrzeug entsprechend anzupassen.



„Megafit“ Art. 926

- universal for front and rear
- without PVC
- checked for toxic substances
- audited quality
- 4-piece on a hanger

Due to the numerous cutting-edges, this rubbermat can be easily adjusted to almost every vehicle.



Art.-Nr.	Farbe	Größe	Einheit	VPE
926998	schwarz	Universal	Satz	6

individuell anpassbar - mit vorgeformten Schnittlinien
 can be cut to size - with preformed cutting lines





Gummi - Rechteckmatten

- Schwere Ausführung
- Ohne PVC
- Schadstoffgeprüft
- Überwachte Qualität



Rectangular rubbermats

- heavy quality
- without PVC
- checked for toxic substances
- audited quality



Art.-Nr.	Größe	VPE / packing Unit
74020	41,5 x 60,5 cm	1 Stück/piece
72020	43 x 30 cm	15 Stück/piece
73020	53 x 37 cm	15 Stück/piece
76020	53 x 70 cm	1 Stück/piece
75120	60 x 40 cm	10 Stück/piece
75220	60 x 40 cm	10 Stück/piece

Ahornblatt
Art. 75120

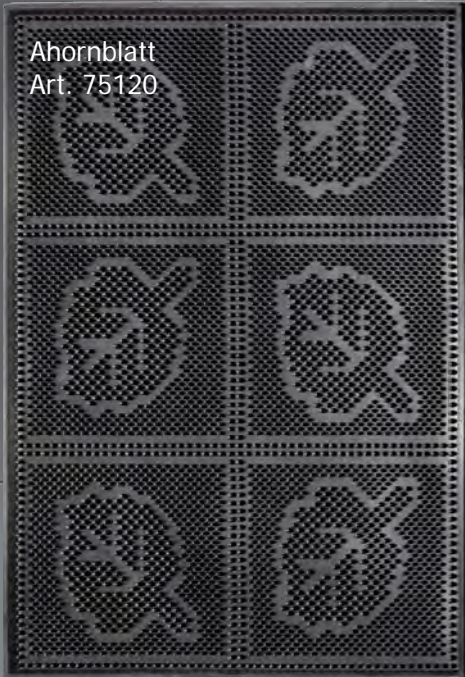

Eichenblatt
Art. 75220

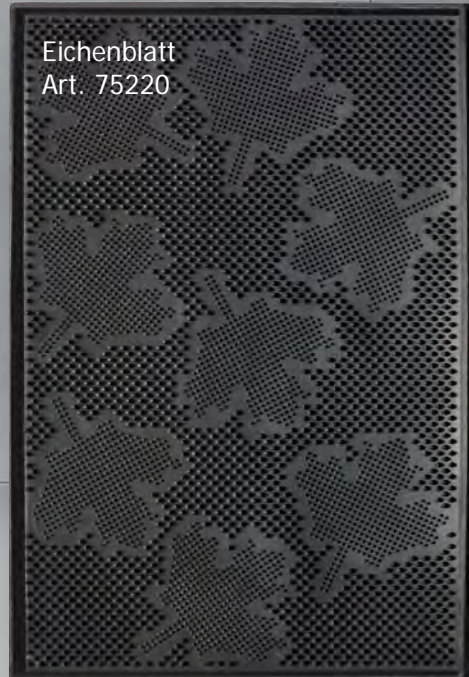

Art. 72020
Art. 73020



Art. 74020
Art. 76020





Gummi - Schalenmatten Stufenmatte

- Hoher Rand als Schmutzfänger
- Ohne PVC
- Schadstoffgeprüft
- Überwachte Qualität
- Stufenmatte mit Klebestreifen auf der Rückseite



Rubber bucket-mats stair-mat

- high edge as dirt trap
- without PVC
- checked for toxic substances
- audited quality
- stair-mat with adhesive tape on the back



Art.-Nr.	Größe	VPE / packing unit
77020	45 x 40 cm	10 Stück/piece
75020	52 x 41 cm	10 Stück/piece
78020	56 x 48 cm	1 Stück/piece
75320	64 x 25 cm	1 Stück/piece

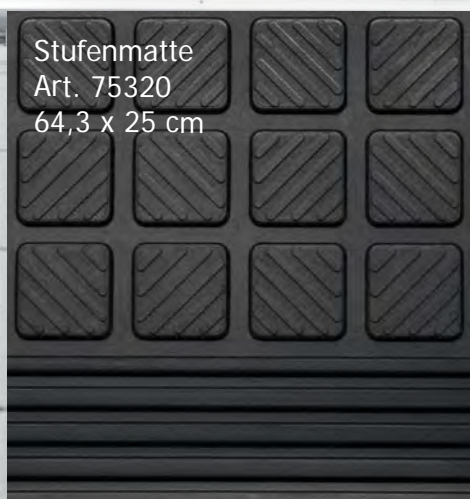
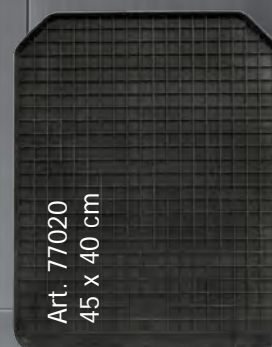

SCHALENMATTEN - STUFEENMATTEN
BUCKET-MATS - STAIR-MATS



Rillengummi (Rollenware)

Art. 435

- Hochwertige Gummiqualität
- Rollenlänge: ca. 10 m
- Härte (ShA): 80 +/- 5
- Qualität: Design S2: SBR
Design S4: SBR-NR
- Gewicht: Design S2: Ca. 4,2 kg/m²
Design S4: Ca. 11 kg/m²



Grooved rubber (on a roll)

Art. 435

- high quality rubber material
- length of a roll: approx. 10 m
- Strength (ShA): 80 +/- 5
- Quality: Design S2: SBR
Design S4: SBR-NR
- Weight: Design S2: approx. 4,2 kg/m²
Design S4: approx. 11 kg/m²

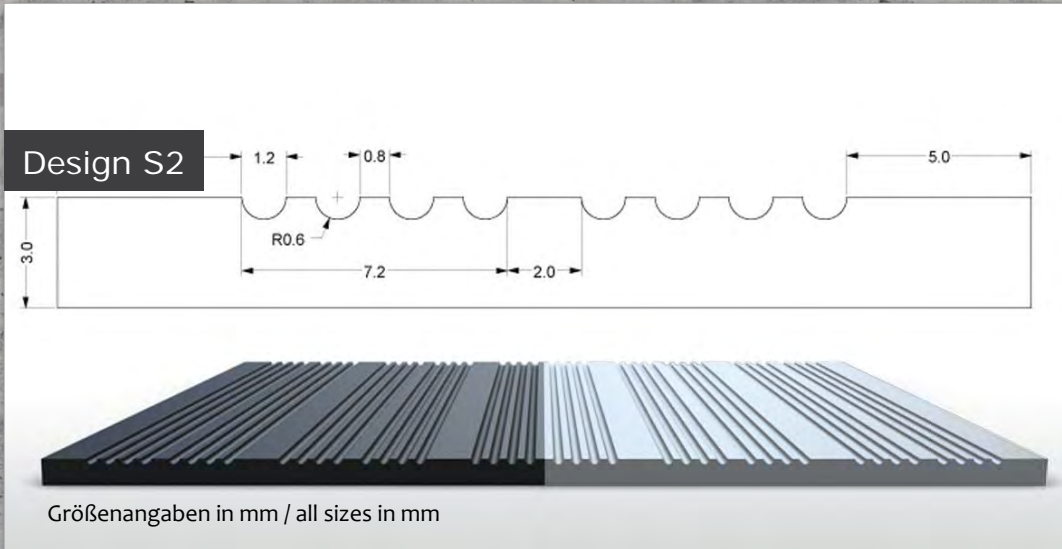

Größenangaben in mm / all sizes in mm

Farbe	Breite	Einheit
schwarz	120 cm	lfm
grau	120 cm	lfm

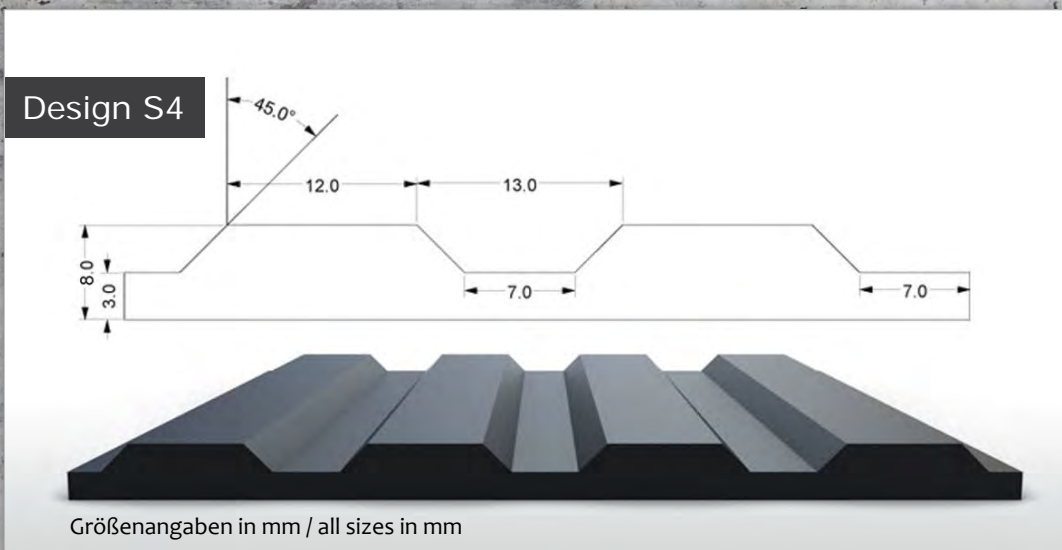

Größenangaben in mm / all sizes in mm

Farbe	Breite	Einheit
schwarz	120 cm	lfm.



Rillengummi (Rollenware)

Art. 435

- Hochwertige Gummiqualität
- Rollenlänge: ca. 10 m
- Härte (ShA): 80 +/- 5
- Qualität: Design S5: SBR
Design S8: SBR-NR
- Gewicht: Design S5: Ca. 4,2 kg/m²
Design S8: Ca. 5,8 kg/m²



Grooved rubber (on a roll)

Art. 435

- high quality rubber material
- length of a roll: approx. 10 m
- Strength (ShA): 80 +/- 5
- Quality: Design S5: SBR
Design S8: SBR-NR
- Weight: Design S5: approx. 4,2 kg/m²
Design S8: approx. 5,8 kg/m²

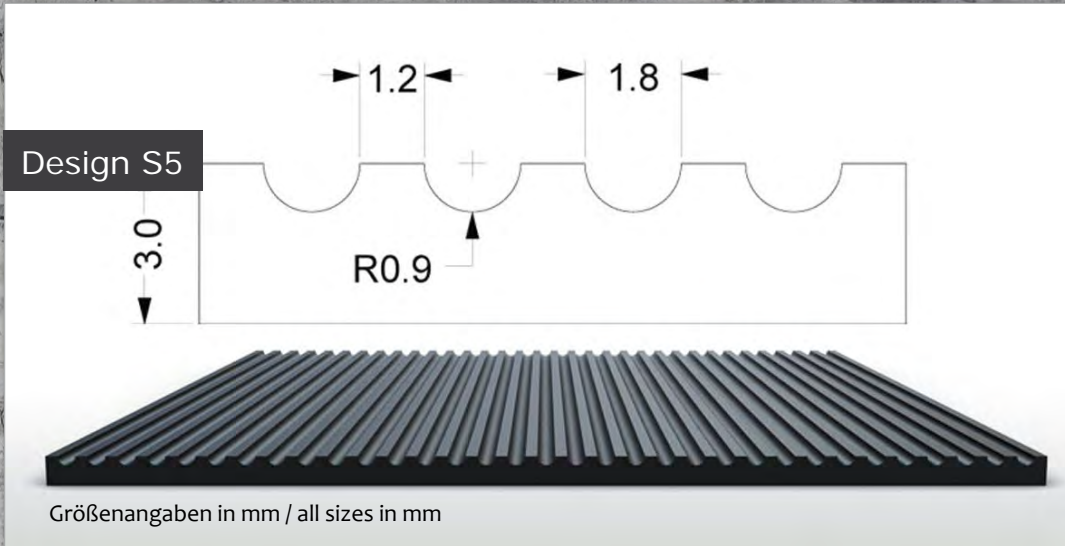

Farbe	Breite	Einheit
schwarz	100 cm	lfm.
schwarz	125 cm	lfm.
schwarz	140 cm	lfm.

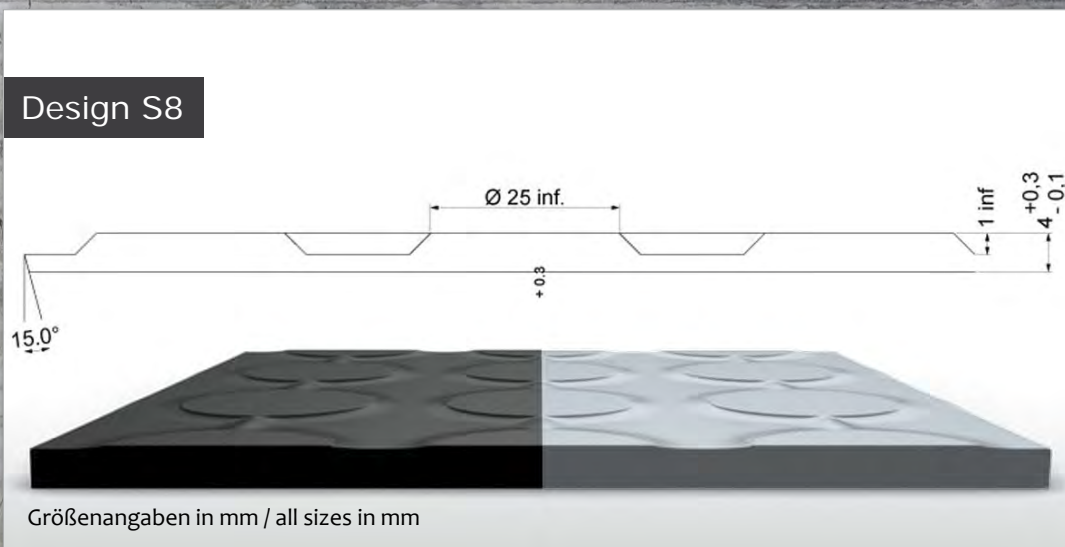

Farbe	Breite	Einheit
schwarz	123 cm	lfm.
grau	123 cm	lfm.



Rillengummi Paßform

Art. 435

- Hochwertige Gummiqualität
- Inklusive Bandeinfassung
- Mögliches Design: S5 (siehe Seite 41)



Grooved rubber customised

Art. 435

- high quality grooved rubber
- Including textile ribbon-bordering
- available design: S5 (see page 41)



Multi-stop Art. 436

- Ideal in Koffer- oder Laderaum
- rutschhemmend, flexibel und formstabil
- gute Reißfestigkeit durch textile Einlage, stark belastbar
- sehr geringe Flüssigkeitsaufnahme durch Spezialprägung
- geräuschkämmend und kälteisolierend
- leicht zu reinigen
- Materialstärke: ca. 3,8 mm
- Gesamtgewicht: ca. 1.800 g / m²



Multi-stop Art. 436

- ideal for trunk and loading spaces
- also available on rolls
- slip-resistant, flexible and dimensionally stable
- good tensile strength due to textile gusset
- very low liquid absorption due to special embossing
- noise-absorbing and cold-insulating
- easy to clean
- material-thickness: approx. 3,8 mm
- total-weight: approx. 1.800 g / m²



Für Fahrzeuge folgender Hersteller bieten wir „Passform-Rillengummi“ und „Multistop“ an:

Customised trunk-mats made of „grooved rubber“ and „Multistop“ are available for the following makes:

Audi	BMW	Citroen	Chevrolet	Fiat
Ford	Honda	Hyundai	Kia	Mazda
Mercedes	Mitsubishi	Nissan	Opel	Peugeot
Renault	Seat	Škoda	Toyota	Volkswagen

Angaben bezüglich einzelner Modelle bzw. weiterer Hersteller entnehmen Sie bitte unserer Modelltabelle oder besuchen Sie unseren Internet-Auftritt unter www.petex.net!

Please see our table of sizes or webpage for further information regarding specific models and other makes!



Schalenmatte

- Besonders strapazierfähig
- 4,5 cm hoher Rand als Schmutzfang
- Eingeklebte Anti-Rutsch-Matte
- Wasser- und ölundurchlässig
- Leicht zu reinigen
- Temperaturbeständig von -40° C bis +80° C
- Abwaschbar



Trunk mat with border

- hard-wearing
- 4,5 cm high edge as dirt trap
- with integrated anti-slip-mat
- water- and oil-proof
- easy to clean
- temperature-resistant from -40° C to +80° C
- washable

Ebenfalls im Sortiment: 4 Universalgrößen / Also available: 4 universal sizes

50 x 90 cm

70 x 90 cm

85 x 90 cm

100 x 90 cm

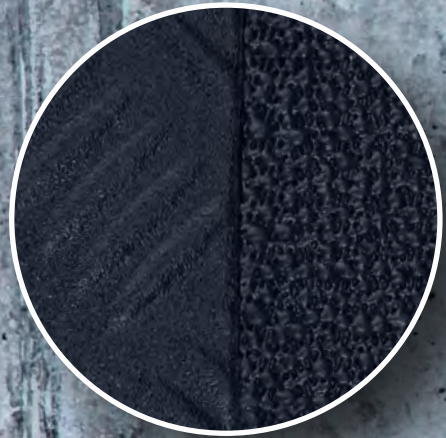

Für Fahrzeuge folgender Hersteller bieten wir Passform-Schalenmatten an:

Fitted trunk-mats are available for vehicles of the following makes:

Audi	BMW	Dacia	Ford	Kia	Mazda	Mercedes
Opel	Peugeot	Seat	Škoda	Volkswagen		

Angaben bezüglich einzelner Modelle bzw. weiterer Hersteller entnehmen Sie bitte unserer Modelltabelle oder besuchen Sie unseren Internet-Auftritt!

Please see our table of sizes or webpage for further information regarding specific models and other makes!



Kofferraummatte Universal Art. 482

- Durch Zuschneiden entlang der Rillen kann diese Matte nahezu jedem Fahrzeug individuell angepasst werden.
- In 2 Größen lieferbar
- Farbe: schwarz
- Schadstoffgeprüft



Trunk mats universal Art. 482

- Due to numerous cutting edges, this trunk-mat can be easily adjusted to almost every car.
- available in 2 sizes
- colour: black
- checked for toxic substances



Größe	Abmessungen
1	110 x 144 cm
2	80 x 127 cm



Die PETEX „First Class“ Sitzbezüge zeichnen sich durch die sorgsam ausgewählten Stoffe, die zum Großteil auch in der Automobilindustrie eingesetzt werden, als auch durch ihre hohe Passgenauigkeit aus. Durch das Know-How, das wir uns seit vielen Jahren durch die Fertigung solch hochwertiger und passgenauer Sitzbezüge angeeignet haben, können wir Ihnen so ein Produkt anbieten, welches Sie hinsichtlich seiner Qualität, der eingesetzten Stoffe sowie der Passform begeistern wird. Sämtliche Aussparungen für Bedienelemente sowie Kartentaschen werden bei PETEX „First Class“ Sitzbezügen entsprechend berücksichtigt. Egal ob Sie einen PKW, Transporter oder LKW mit unseren Sitzbezügen ausstatten wollen, für fast alle Fahrzeugtypen, auch ältere Baujahre, ist bei uns ein Schnitt vorhanden. Durch die Produktion an unserem deutschen Standort können wir zudem schnell und flexibel auf Kundenwünsche reagieren.

Wir sind überzeugt, dass Sie mit Ihrem neuen PETEX-Maß-Sitzbezug zufrieden sein werden. Deshalb gewähren wir auf alle PETEX „First Class“ Sitzbezüge eine erweiterte Herstellergarantie von 3 Jahren auf Passform und Stoffbeständigkeit. Auch nach Ablauf dieser Gewährleistungsfrist können bei diesen Sitzbezügen gegebenenfalls einzelne Teile nach Bedarf kostengünstig ausgetauscht werden.

The PETEX „First Class“ seat-covers are characterized by the carefully selected materials, which for the most part are also being used in the automotive industry, as well as by its superior fitting accuracy. Due to the know-how, which we have been acquiring for many years from producing such high-quality, precise-fitting seat-covers, we are able to offer you a product that will inspire you in terms of quality, the materials used as well as its superior fit. All the openings for control levers and map-pockets are considered accordingly in our PETEX „First Class“ seat-covers. Regardless of which vehicle you want to equip with our seat-covers, a passenger car, transporter or truck – we got the right pattern for almost all types of vehicle, including older models. Thanks to the production at our German facilities, we can react quickly and flexibly to customers' needs.

We are convinced you will be satisfied with your new PETEX „First Class“ seat-covers. Therefore, we grant an extended manufacturers' warranty of 3 years in regards of its fit and fabric durability, of all PETEX „First Class“ seat-covers. Even after this warranty period has expired, single parts can be replaced inexpensively as required.



Sitzbezüge der „Business Line“ zeichnen sich ebenfalls durch ausgewählte, ausschließlich in der EU produzierte Stoffe aus. Auch diese Sitzbezüge werden ausschließlich in Deutschland gefertigt. Die Passform entspricht der unserer Bezüge aus der „Economy Class“, jedoch mit dem Unterschied, das Sie auch hier, wie bei der „First Class“, Bezüge für Transporter, Kombis und LKW erwerben können. Mögliche Variationen entnehmen Sie bitte der Seite nebenan

Seat covers of our „Business Line“ are also distinguished by its selected fabrics, which are exclusively produced in the EU. These seat-covers are also produced exclusively in Germany. The fit corresponds to the fit of our „Economy Class“ seat-covers. However, just as for „First Class“ seat-covers you can also purchase covers made for transporters, station wagons and trucks. For possible variations, please see the listing on the right hand side.



Die Bezüge unserer „Eco Class“ sind, je nach Qualität, als Komplett-Set und Vordersitzgarnitur lieferbar.

Vordersitze „SAB 1“ (2-teilig) und „SAB2“ (1-teilig)

Dieser Vordersitzbezug wird inklusive Sollreißnaht für Fahrzeuge mit Seitenairbag gefertigt. Er ist sowohl für alle Fahrzeuge mit Seitenairbag (soweit von TÜV und KBA geprüft und freigegeben), als auch für alle Fahrzeuge ohne Seitenairbag geeignet - und somit für nahezu alle Modelle passend.

Rücksitzbezug „Vario“

An der Lehne und der Sitzfläche der Rücksitzbank sind jeweils 2 Reißverschlüsse eingearbeitet. Dadurch kann der Sitzbezug je nach Bedarf an der entsprechenden Stelle geteilt werden.

Rücksitzbezug „Vario Plus“ (siehe Abbildung unten)

An der Lehne und der Sitzfläche der Rücksitzbank sind jeweils 3 Reißverschlüsse eingearbeitet. So haben Sie zusätzlich die Möglichkeit, ein Mittelteil des Bezuges herauszunehmen (1), um die Passgenauigkeit des Bezuges zu erhöhen.

Ebenfalls sind Seitenabdeckungsteile im Lieferumfang enthalten, mit denen Sie die Möglichkeit haben, die freien Seitenteile, welche beim Umklappen des Rücksitzes sichtbar werden, ebenfalls zu beziehen (2).

Depending on the design, seat-covers of our „Eco Class“ are available as complete set and set for front seats only.

Front seats „SAB 1“ (2-piece) and „ SAB2 „ (1-piece)

This front seat-cover comes including “special-seam” for vehicles with integrated side-airbags. It is suitable for cars with side-airbag (if it has been tested and approved by the TÜV and KBA = German Federal Bureau of Motor Vehicles and Drivers) as well as for cars without side-airbag – and, therefore, is suitable for almost all vehicles.

Rear seat-cover „Vario“

In this backseat-cover you find four zippers (two in the bench and two in the back). This way, the seat-covers can be easily divided according to your needs.

Rear seat cover „Vario Plus“ (see image below)

This backseat-cover comes with six zippers (three in the bench and three in the back). Compared to the “Vario” backseat-cover, you have an additional feature with this pattern – you can easily take out one or two pieces of the seat-covers in order to adjust its width to the backseat of your car (1) – to have a more accurate fit. Along with the “Vario Plus” backseat-cover you also get four small covers which can be used to cover the insides of the backseat, which can be seen when the backseat is folded (2).



PETEX - Sitzbezüge mit „Sollreissnaht“

Alle PETEX-Sitzbezüge (Maß- und Universalset), welche die entsprechende TÜV-Freigabe erhalten haben und auch vom KBA freigegeben wurden, werden mit einer entsprechenden Sollreißnaht produziert. Dadurch ist gewährleistet, dass sich der Seitenairbag im Falle eines Unfalls ungehindert, wie geplant, voll entfalten kann. Ob die Bezüge auch für Ihr Fahrzeug von TÜV und KBA freigegeben wurden, können Sie in unserer Modelltabelle nachlesen.



Die TUVdotCOM-ID dient als Schlüssel zu allen Zertifikaten, welche die TÜV Rheinland Group ausstellt. Mit dieser zehnstelligen Zahl ist der Zugriff auf alle geprüften Eigenschaften eines Produktes, einer Dienstleistung oder eines Unternehmens jederzeit im Internet möglich. Geben Sie die ID in ein Datenfeld auf der TÜV-Homepage www.tuv.com ein, und Sie werden sofort an einen Überblick der Prüfergebnisse weitergeleitet.



















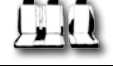



PETEX – seat-covers with „special-seam“

All PETEX seat-covers (tailor-made as well as universal set), which have been tested and approved by the TÜV and the KBA (=German Federal Bureau of Motor Vehicles and Drivers) come including a “special-seam”. This seam ensures that in case of an accident the airbag can unfold, as designed, without any problems. Please take a look at our table of sizes to check whether the seat-covers with special-seam have also been tested and approved for your vehicle by the TÜV and KBA.



The TUVdotCOM ID is the key to all certificates that TÜV Rheinland Group issues. Using this ten-digit number, all of the properties of a product, a service or an organisation that have been tested can be accessed at any time on the Internet. Enter the ID into a data field on the TÜV homepage www.tuv.com and you will be taken straight to an overview of the test results.



 First-Class Bezüge für PKW und LKW, inklusive Kopfstützbezüge First-Class covers für cars and trucks, including covers for head-rests	 Universal-Bezüge für PKW, LKW und Transporter Universl seat-covers for cars, trucks and transporter	 Universal-Bezüge für PKW Universal seat-covers for cars
 Vordersitzgarnitur PKW set of front seat-covers passenger cars	 Vordersitzgarnitur PKW set of front seat-covers passenger cars	 Vordersitzgarnitur set of front seat-covers
 Komplettgarnitur PKW complete set passenger cars	 Komplettgarnitur PKW complete set passenger cars	 Komplettgarnitur complete set
 Vordersitzgarnitur Einzelsitz + Doppelsitz front seat-covers single seat + double seat	 Vordersitzgarnitur Einzelsitz + Doppelsitz front seat-covers single seat + double seat	
 Einzelsitz hinten single seat for passenger compartment	 2 x Einzelsitz vorne 2 x single seat front	
 3er Sitzreihe hinten 3-seat backseat-cover rear	 Einzelsitz hinten single seat for passenger compartment	
 Doppelsitz hinten double seat for passenger compartment	 3er Sitzreihe hinten 3-seat backseat-cover rear	
 LKW-Sitz seat for Trucks	 Doppelsitz hinten double seat for passenger compartment	
 Armlehnenbezug armrest-cover	 LKW-Sitz Größe 1 Seat for Trucks - size 1	
	 LKW-Sitz Größe 2 Seat for Trucks - size 2	
	 Kopfstützbezug headrest-cover	



Berlin



Berlin Art. 253

- **Mittelteil:**
Jaquard gewebt, 100% Polyester

- **Seitenteile, Rücken und Umrandung:**
Uni-Trikot, 100% Polyester

Alle Stoffe kaschiert, zusätzlich mit Trikot, zum Schutz des Original-Bezugs



Berlin Art. 253

- **middle section:**
Jaquard, woven, 100% polyester

- **side sections, backside and border:**
Uni-tricot, 100% polyester

All fabrics laminated, with additional lining, to protect the original seat-covers.



18 grau

SITZBEZÜGE - SEAT-COVERS



Genua



Genua Art. 293

- **Mittelteil:**
Flach-Jacquard, gewirkt, 100% Polyester
- **Seitenteile, Rücken und Umrandung:**
Uni-Trikot, 100% Polyester

Alle Stoffe kaschiert, zusätzlich mit Trikot, zum Schutz des Original-Bezugs



Genua Art. 293

- **middle section:**
flat-jacquard, knitted, 100% polyester
- **side sections, backside and border:**
uni-tricot, 100% polyester

All fabrics laminated, with additional lining, to protect the original seat-covers.



04 schwarz

SITZBEZÜGE - SEAT-COVERS

Bern



09 beige

SITZBEZÜGE - SEAT-COVERS

**Bern Art. 219**

- **Mittelteil:**
Flach-Jacquard, gewebt
100% Polyester
- **Seitenteile, Rücken und Umrandung:**
Uni-Trikot, 100% Polyester

Alle Stoffe kaschiert, zusätzlich mit Trikot, zum Schutz des Original-Bezugs

**Bern Art. 219**

- **middle section:**
flat-jacquard, woven
100% polyester
- **side sections, backside and border:**
uni-tricot, 100% polyester

All fabrics laminated, with additional lining, to protect the original seat-covers.

**18 grau****05 blau**

Diamant



SITZBEZÜGE - SEAT-COVERS

02 graphit



Diamant Art. 208

- Mittelteil:
Jacquard-Velours, 100% Polyester
- Seitenteile, Rücken und Umrandung:
Jacquard-Velours, 100% Polyester

Alle Stoffe kaschiert, zusätzlich mit Trikot, zum Schutz des Original-Bezugs



Diamant Art. 208

- middle section:
jacquard-velours, 100% polyester
- side sections, backside and border:
jacquard-velours, 100% polyester

All fabrics laminated, with additional lining, to protect the original seat-covers.



03 silber

King



SITZBEZÜGE - SEAT-COVERS

03 silber



King Art. 203

- Durch die Konstruktion des Mittelteils besitzt dieser Bezug eine hohe Festigkeit bei gleichzeitiger optimaler Klimatisierung
- Durch die Stoff-Konstruktion wird die Kontaktfläche des Körpers zum Sitz verringert und somit auch ein möglicher Wärmestau reduziert, bei Bewegung auf dem Bezug bzw. dem Sitz entsteht so automatisch eine Luftzirkulation
- Durch den dreidimensionalen Aufbau des Stoffs (ca. 3,5 mm) ist keine zusätzliche Laminierung des Materials mehr erforderlich und somit eine sehr gute Feuchtigkeitsableitung und Luftdurchlässigkeit gegeben. Die eingesetzten Garnqualitäten unterstützen diese Prozesse zusätzlich.
- edles Design mit effektivem, metallischen Kontrastgarn
- **Mittelteil:**
100 % Polyester
- **Seitenteile, Rücken, Umrandung:**
Uni-Trikot, 100% Polyester, **kaschiert, zusätzlich mit Trikot, zum Schutz des Original-Bezugs**



King Art. 203

- due to the construction of the middle section, this seat-cover is very sturdy and also ensures a comfortable climatisation
- the fabric-construction reduces a possible heat accumulation
- when moving on the seat-cover, respectively on the seat, virtually a good circulation of air is being generated automatically
- thanks to the three-dimensional construction of the fabric (approx. 3,5 mm) no additional lamination of the material is needed, which helps to improve the moisture absorption and air permeability. The used yarn types also support these processes.
- classy design with effective, metallic contrast-yarn
- **Middle-section:**
100 % polyester
- **Side sections, backside and border:**
Uni-tricot, 100% polyester, **laminated, with additional lining, to protect the original seat-covers.**



05 blau

Luzern



SITZBEZÜGE - SEAT-COVERS

03 silber



Luzern Art. 236

- Mittelteil:
Jaquard, gewebt, 100% Polyester

- Seitenteile, Rücken und Umrandung:
Uni-Trikot, 100% Polyester

**Alle Stoffe kaschiert, zusätzlich mit
Trikot, zum Schutz des Original-Bezugs**



Luzern Art. 236

- middle section:
Jaquard, woven, 100% Polyester

- side sections, backside and border:
Uni-tricot, 100% Polyester

**All fabrics laminated, with additional
lining, to protect the original
seat-covers.**



02 graphit

Nevada



SITZBEZÜGE - SEAT-COVERS

09 beige



Nevada Art. 281

- Mittelteil:

Flach-Jacquard, gewebt
100% Polyester

- Seitenteile, Rücken und Umrandung:
Uni-Trikot, 100% Polyester

**Alle Stoffe kaschiert, zusätzlich mit
Trikot, zum Schutz des Original-Bezugs**



Nevada Art. 281

- middle section:

flat-jacquard, woven
100% polyester

- side sections, backside and border:
uni-tricot, 100% polyester

**All fabrics laminated, with additional
lining, to protect the original
seat-covers.**



18 grau

Regent

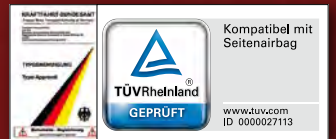
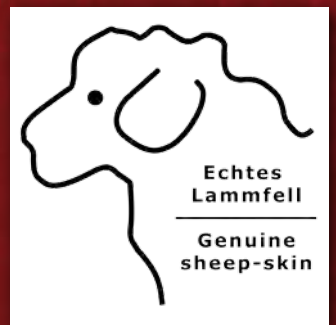

SITZBEZÜGE - SEAT-COVERS

01 antzhrazit



Regent Art. 322

- Mittelteil und Seitenteile:
Echtes Lammfell (Wollhöhe 16 - 18 mm)
- Rücken und Umrandung:
Jacquard-Velours,
100% Polyester

Alle Stoffe kaschiert, zusätzlich mit Trikot, zum Schutz des Original-Bezugs



Regent Art. 322

- middle section and side sections:
genuine lambskin (wool-height 16 - 18 mm)
- backside and border:
jacquard-velours,
100% polyester

All fabrics laminated, with additional lining, to protect the original seat-covers.



03 silber



Riga



Riga Art. 239

- Mittelteil:
Jaquard, gewebt, 100% Polyester

- Seitenteile, Rücken und Umrandung:
Uni-Trikot, 100% Polyester

Alle Stoffe kaschiert, zusätzlich mit Trikot, zum Schutz des Original-Bezugs



Riga Art.239

- middle section:
Jaquard, woven, 100% Polyester

- side sections, backside and border:
Uni-tricot, 100% Polyester

All fabrics laminated, with additional lining, to protect the original seat-covers.



Kompatibel mit Seitenairbag

www.tuv.com
ID 0000027113



18 grau

SITZBEZÜGE - SEAT-COVERS



Rom



Rom Art. 213

- Mittelteil:
Jaquard, gewebt, 100% Polyester

- Seitenteile, Rücken und Umrandung:
Uni-Trikot, 100% Polyester

Alle Stoffe kaschirt, zusätzlich mit Trikot, zum Schutz des Original-Bezugs



Rom Art.213

- middle section:
Jaquard, woven, 100% Polyester

- side sections, backside and border:
Uni-tricot, 100% Polyester

All fabrics laminated, with additional lining, to protect the original seat-covers.

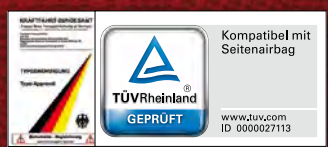

18 grau

SITZBEZÜGE - SEAT-COVERS

Royal



SITZBEZÜGE - SEAT-COVERS



39 steingrau



Royal Art. 294

- **Mittelteil und Seitenteile:**
Baumwolle 8%, Acryl 43%, Polyamid 20%, Polyester 29%
- Scheuerfestigkeit geprüft nach Martindale >100.000
- Reißfestigkeit >20 N (BS4303) 3 daN (DIN 53859-5)
- Veredelt mit **SAFEFRONT**
- **Rücken und Umrandung:**
100% Polyester gestrickt

Alle Stoffe kaschiert, zusätzlich mit Trikot, zum Schutz des Original-Bezugs



Royal Art. 294

- **middle and side sections:**
8 % cotton, 43 % acrylic, 20 % polyamide, 29 % polyester
- abrasion, tested according to Martindale, > 100.000
- breaking strength > 20 N (BS4303) 3 daN (DIN 53859-5)
- refined with **SAFEFRONT**
- **backside and border:**
100% polyester knitted

All fabrics laminated, with additional lining, to protect the original seat-covers.



- Safe Front schützt gegen Milben, Bakterien und Pilzen, welche die Ursache für Allergien sind.
- Safe Front ist frei von Insektiziden und anderen flüchtigen Substanzen.
- Safe Front sorgt für einen maximalen hygienischen Schutz Ihrer Bezugsstoffe, damit Sie sich weiterhin bester Gesundheit erfreuen können.

- Safe front protects against dust mites, bacteria and fungi, which are the cause of allergies.

- Safe front is free of insecticides and other volatile substances.
- Safe front ensures a maximum hygiene protection of your upholstery fabrics, so you can continue to enjoy excellent health.

Pflegeanleitung

Dank der besonderen Stoffbeschaffenheit können selbst schwierigste Flecken in nur 3 Schritten beseitigt werden:

1. Ein Papiertaschentuch mit Wasser anfeuchten
2. Den Fleck mit kreisförmigen Bewegungen abreiben
3. Nimmt man das Papiertaschentuch weg, ist auch der Fleck verschwunden

Um die Lebensdauer des Stoffes zu verlängern sollte dieser nicht in der Waschmaschine gewaschen werden.

Care instructions

Due to the special material composition even the most tenacious stains can be easily removed in only three steps:

1. moisten a tissue with water
2. abrade the stains with circular movement
3. take the tissue away and the stain is gone

In order to extend the durability of the fabric it should not be washed in the washing machine.



02 graphit



04 schwarz



09 beige





San Marino



San Marino Art. 215

- Mittelteil:
Jaquard, gewebt, 100% Polyester

- Seitenteile, Rücken und Umrandung:
Uni-Trikot, 100% Polyester

Alle Stoffe kaschiert, zusätzlich mit
Trikot, zum Schutz des Original-Bezugs



San Marino Art. 215

- middle section:
Jaquard, woven, 100% Polyester

- side sections, backside and border:
Uni-tricot, 100% Polyester

All fabrics laminated, with additional
lining, to protect the original
seat-covers.



Kompatibel mit
Seitenairbag

www.tuv.com
ID 000027113

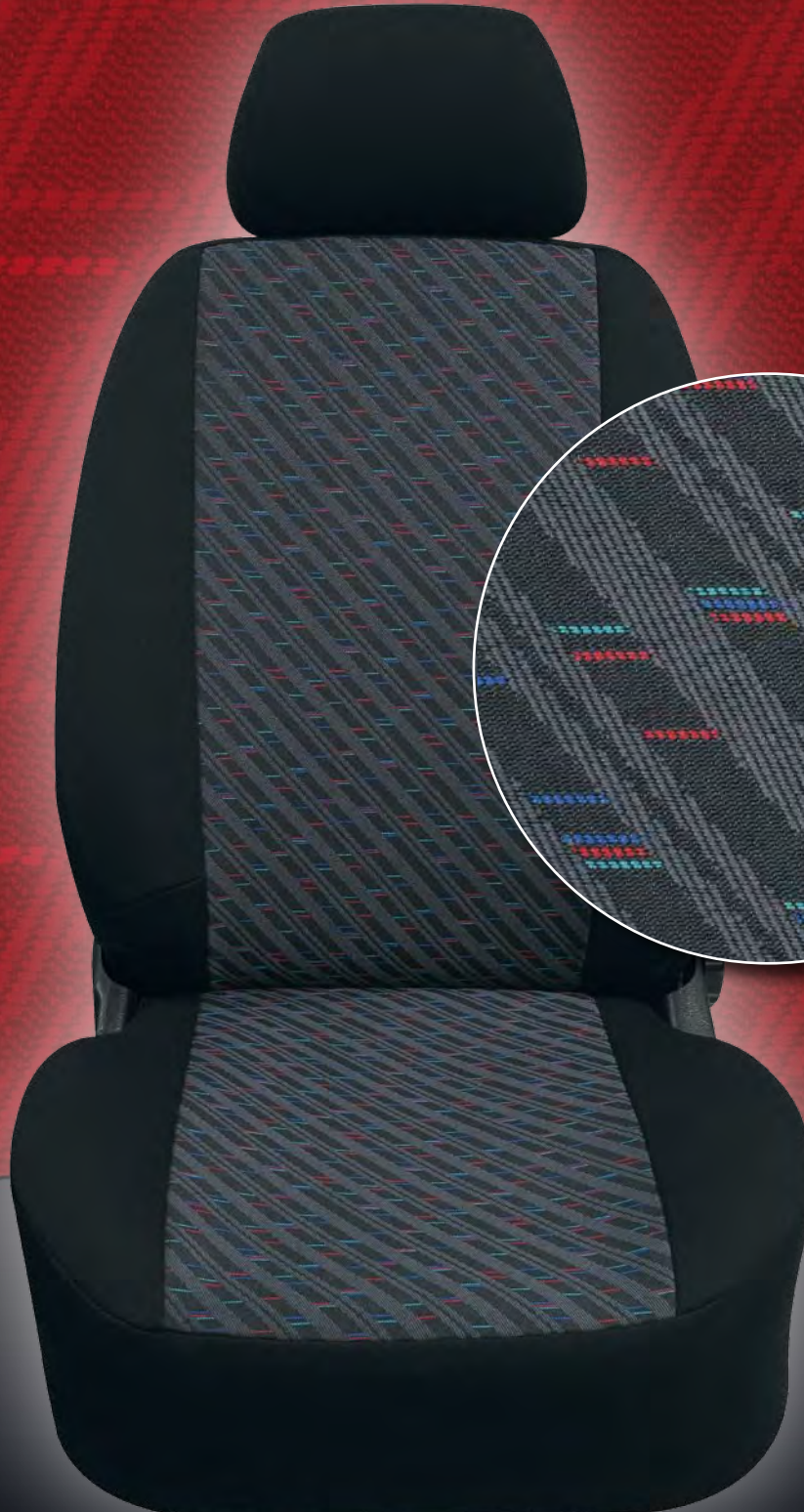



04 schwarz

SITZBEZÜGE - SEAT-COVERS



Wien



 Wien Art. 254 - Mittelteil: Jaquard, gewebt, 100% Polyester - Seitenteile, Rücken und Umrandung: Uni-Trikot, 100% Polyester Alle Stoffe kaschiert, zusätzlich mit Trikot, zum Schutz des Original-Bezugs	 Wien Art.254 - middle section: Jaquard, woven, 100% Polyester - side sections, backside and border: Uni-tricot, 100% Polyester All fabrics laminated, with additional lining, to protect the original seat-covers.
---------------------------------------------------------------------------------------------------------------------------------------------------------------------------------------------------------------------------------------------------------------------------------------------------------------------------------	-------------------------------------------------------------------------------------------------------------------------------------------------------------------------------------------------------------------------------------------------------------------------------------------------------------------------------------------



SITZBEZÜGE - SEAT-COVERS

04 schwarz

Taxi



SITZBEZÜGE - SEAT-COVERS

04 schwarz



Taxi Art. 210

- Mittelteil:
Lederimitat mit Prägung, schaumstoffkaschiert
- Seitenteile, Rücken und Umrandung:
Lederimitat



Taxi Art. 210

- Middle section:
imitation leather embossed, laminated with foam
- Side sections, backside and border:
imitation leather



Mosel



Komplettsset SAB 1 Vario plus / SAB 2 Vario plus
Complete Set SAB 1 Vario plus / SAB 2 Vario plus



SITZBEZÜGE - SEAT-COVERS

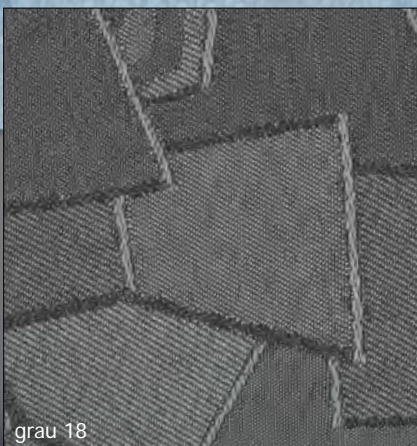

grau 18



Vordersitzgarnitur SAB 1 / SAB 2
Set of front-seat-covers SAB 1 / SAB 2



Mosel Art. 267

- **Mittelteil:**
Jaquard gewebt, 100% Polyester
- **Seitenteile, Rücken und Umrandung:**
Uni-Trikot, 100% Polyester

Alle Stoffe kaschiert, zusätzlich mit Trikot, zum Schutz des Original-Bezugs



Mosel Art.267

- **middle section:**
jaquard woven, 100% Polyester
- **side sections, backside and border:**
Uni-tricot, 100 % Polyester

All fabrics laminated, with additional lining, to protect the original seat-covers.



TRANSPORTER UND KOMBIS



Einzelsitz/Doppelsitz vorne
Single-seat / double-seat front



2x Einzelsitz vorne
2x single seat front



Einzelsitz hinten
single seat rear



Doppelsitz hinten
double seat rear



3er Sitzbank hinten
3 seat bench rear

LKW

- Geeignet für Sitze **mit** und **ohne** Sitzgurt
- integrierte Öffnung für **Armlehnen**
- geeignet für Sitze mit **steckbarer** und **integrierter** Kopfstütze



LKW-Sitz Universal Größe 1



LKW-Sitz Universal Größe 2

- Beidseitige Aussparung **mit Klett** zum durchführen des Sitzgurtes
- integrierte Öffnung für **Armlehnen**

- Suitable for seats **with** and **without** seat belt
- integrated opening for **arm rests**
- suitable for seats with **plugable & integrated** headrest

- openings **with velcro** on both sides to pull through the seat belt
- integrated opening for **arm rests**

Isar



Komplettsatz SAB 1 Vario plus / SAB 2 Vario plus
Complete Set SAB 1 Vario plus / SAB 2 Vario plus



Vordersitzgarnitur SAB 1 / SAB 2
Set of front-seat-covers SAB 1 / SAB 2

SITZBEZÜGE - SEAT-COVERS

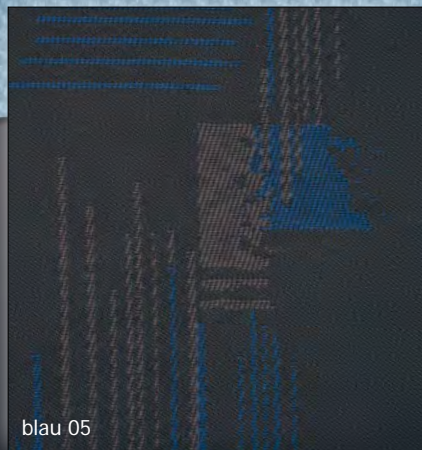

blau 05



rot 12

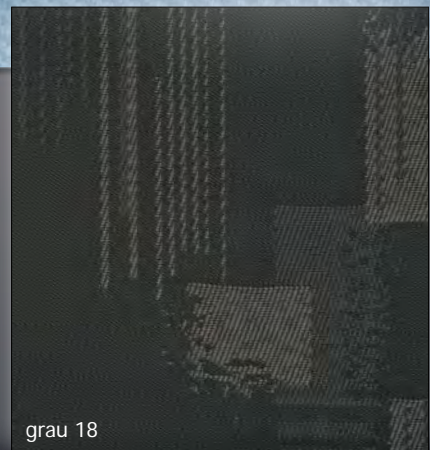

grau 18



Isar Art. 255

- **Mittelteil:**
Jaquard gewebt, 100% Polyester
- **Seitenteile, Rücken und Umrandung:**
Uni-Trikot, 100% Polyester

Alle Stoffe kaschiert, zusätzlich mit Trikot, zum Schutz des Original-Bezugs



Isar Art.255

- **middle section:**
jaquard woven, 100% Polyester
- **side sections, backside and border:**
Uni-tricot, 100 % Polyester

All fabrics laminated, with additional lining, to protect the original seat-covers.



TRANSPORTER UND KOMBIS



Einzelsitz/Doppelsitz vorne
Single-seat / double-seat front



2x Einzelsitz vorne
2x single seat front



Einzelsitz hinten
single seat rear



Doppelsitz hinten
double seat rear



3er Sitzbank hinten
3 seat bench rear

LKW

- Geeignet für Sitze **mit** und **ohne** Sitzgurt
- integrierte Öffnung für **Armlehnen**
- geeignet für Sitze mit **steckbarer** und **integrierter** Kopfstütze



LKW-Sitz Universal Größe 1



LKW-Sitz Universal Größe 2

- Beidseitige Aussparung **mit Klett** zum durchführen des Sitzgurtes
- integrierte Öffnung für **Armlehnen**

- Suitable for seats **with** and **without** seat belt
- integrated opening for **arm rests**
- suitable for seats with **pluggable & integrated** headrest

- openings **with velcro** on both sides to pull through the seat belt
- integrated opening for **arm rests**

Lech



Komplettsset SAB 1 Vario plus / SAB 2 Vario plus
Complete Set SAB 1 Vario plus / SAB 2 Vario plus

SITZBEZÜGE - SEAT-COVERS



graphit 02



Vordersitzgarnitur SAB 1 / SAB 2
Set of front-seat-covers SAB 1 / SAB 2



Lech Art. 268

- **Mittelteil:**
Jaquard gewebt, 100% Polyester
- **Seitenteile, Rücken und Umrandung:**
Uni-Trikot, 100% Polyester

Alle Stoffe kaschiert, zusätzlich mit Trikot, zum Schutz des Original-Bezugs



Lech Art.268

- **middle section:**
jaquard woven, 100% Polyester
- **side sections, backside and border:**
Uni-tricot, 100 % Polyester

All fabrics laminated, with additional lining, to protect the original seat-covers.



TRANSPORTER UND KOMBIS



Einzelsitz/Doppelsitz vorne
Single-seat / double-seat front



2x Einzelsitz vorne
2x single seat front



Einzelsitz hinten
single seat rear

Doppelsitz hinten
double seat rear



3er Sitzbank hinten
3 seat bench rear

LKW

- Geeignet für Sitze **mit** und **ohne** Sitzgurt
- integrierte Öffnung für **Armlehnen**
- geeignet für Sitze mit **steckbarer** und **integrierter** Kopfstütze



LKW-Sitz Universal Größe 1

- Suitable for seats **with** and **without** seat belt
- integrated opening for **arm rests**
- suitable for seats with **pluggable & integrated** headrest



LKW-Sitz Universal Größe 2

- Beidseitige Aussparung **mit Klett** zum durchführen des Sitzgurtes
- integrierte Öffnung für **Armlehnen**

- openings **with velcro** on both sides to pull through the seat belt
- integrated opening for **arm rests**

Rhein



Komplettsset SAB 1 Vario plus / SAB 2 Vario plus
Complete Set SAB 1 Vario plus / SAB 2 Vario plus

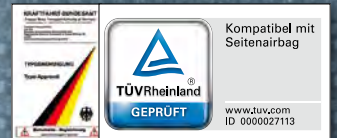

SITZBEZÜGE - SEAT-COVERS



grau 18



Vordersitzgarnitur SAB 1 / SAB 2
Set of front-seat-covers SAB 1 / SAB 2



Rhein Art. 262

- **Mittelteil:**
Jaquard gewebt, 100% Polyester
- **Seitenteile, Rücken und Umrandung:**
Uni-Trikot, 100% Polyester

Alle Stoffe kaschiert, zusätzlich mit Trikot, zum Schutz des Original-Bezugs



Rhein Art.262

- **middle section:**
jaquard woven, 100% Polyester
- **side sections, backside and border:**
Uni-tricot, 100 % Polyester

All fabrics laminated, with additional lining, to protect the original seat-covers.



TRANSPORTER UND KOMBIS



Einzelsitz/Doppelsitz vorne
Single-seat / double-seat front



2x Einzelsitz vorne
2x single seat front



Einzelsitz hinten
single seat back



Doppelsitz hinten
double seat back



3er Sitzbank hinten
3 seat bench back

LKW

- Geeignet für Sitze **mit** und **ohne** Sitzgurt
- integrierte Öffnung für **Armlehnen**
- geeignet für Sitze mit **steckbarer** und **integrierter** Kopfstütze

- Suitable for seats **with** and **without** seat belt
- integrated opening for **arm rests**
- suitable for seats with **plugable & integrated** headrest



LKW-Sitz Universal Größe 1



LKW-Sitz Universal Größe 2

- Beidseitige Aussparung **mit Klett** zum durchführen des Sitzgurtes
- integrierte Öffnung für **Armlehnen**

- openings **with velcro** on both sides to pull through the seat belt
- integrated opening for **arm rests**



Spree



Spree Art. 272

- Mittelteil:
Flach-Jaquad, gewirkt, 100% Polyester
- Seitenteile, Rücken und Umrandung:
Uni-Trikot, 100% Polyester

Alle Stoffe kaschiert, zusätzlich mit Trikot, zum Schutz des Original-Bezugs



Spree Art.272

- middle section:
flat jaquad knitted, 100% Polyester
- side sections, backside and border:
Uni-tricot, 100 % Polyester

All fabrics laminated, with additional lining, to protect the original seat-covers.



Komplettsset SAB 1 Vario plus / SAB 2 Vario plus
Complete Set SAB 1 Vario plus / SAB 2 Vario plus

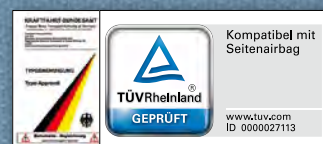

SITZBEZÜGE - SEAT-COVERS



schwarz 04



Vordersitzgarnitur SAB 1 / SAB 2
Set of front-seat-covers SAB 1 / SAB 2



Neckar



Neckar Art. 274

- Mittelteil und Seitenteile:
Gewirkt, wattiert, 100% Polyester
- Rücken und Umrandung:
Uni-Trikot, 100% Polyester **kaschiert**,
zusätzlich mit Trikot, zum Schutz des
Original-Bezugs



Neckar Art. 274

- middle section and side sections:
knitted, basted, 100% polyester
- backside and border:
uni-tricot, 100% polyester **laminated**,
with additional lining, to protect the
original seat-covers.



Komplettsset SAB 1 Vario plus / SAB 2 Vario plus
Complete Set SAB 1 Vario plus / SAB 2 Vario plus



Vordersitzgarnitur SAB 1 / SAB 2
Set of front-seat-covers SAB 1 / SAB 2

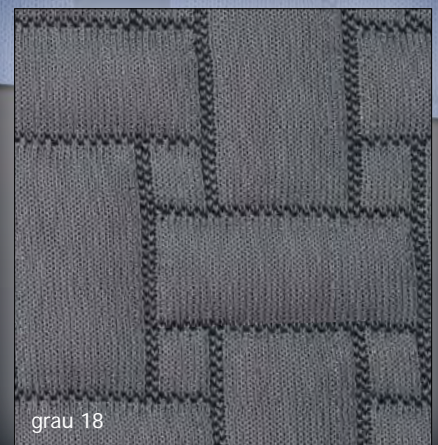

grau 18



Inn



grau 18

Komplettsset SAB 1 Vario plus / SAB 2 Vario plus
Complete Set SAB 1 Vario plus / SAB 2 Vario plus

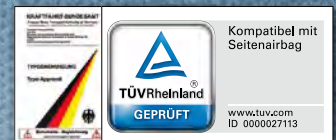

SITZBEZÜGE - SEAT-COVERS



grau 18

Vordersitzgarnitur SAB 1 / SAB 2
Set of front-seat-covers SAB 1 / SAB 2



Inn Art. 273

- **Mittelteil:**
Flach-Jaquard, gewirkt, 100% Polyester
- **Seitenteile, Rücken und Umrandung:**
Uni-Trikot, 100% Polyester
- mit attraktiver Doppelnaht-Prägung

Alle Stoffe kaschiert, zusätzlich mit Trikot, zum Schutz des Original-Bezugs



Inn Art.273

- **middle section:**
flat-jacquard knitted, 100% Polyester
- **side sections, backside and border:**
Uni-tricot, 100 % Polyester
- with attractive double-seam embossing

All fabrics laminated, with additional lining, to protect the original seat-covers.

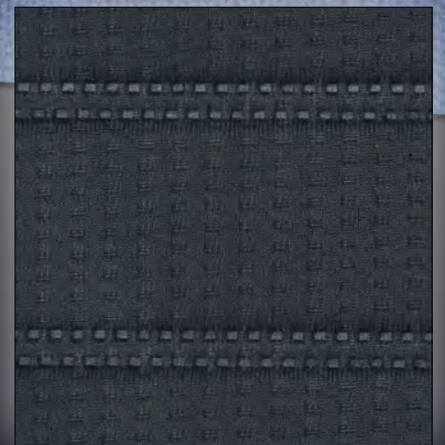



Active Sports



Active Sports Art. 223

- **Mittelteil:**
100% Polyester, geprägt, extra dicke Kaschierung
- **Seitenteile, Rücken und Umrandung**
100% Polyester-Trikot



Active Sports Art. 223

- **middle section:**
100% polyester, embossed, extra thick lamination
- **side sections, backside and border:**
100% polyester-tricot

Art.-Nr.	Farbe	Größe	Ausführung	VPE
22374804	schwarz	SAB 1 Vario	Set 11-tlg.	10
22374805	blau	SAB 1 Vario	Set 11-tlg.	10
22374812	rot	SAB 1 Vario	Set 11-tlg.	10

SITZBEZÜGE - SEAT-COVERS



12 rot



05 blau



04 schwarz



Fashion



Fashion Art. 277

- Mittelteil und Seitenteile:
100% Polyester-Gewirke, kaschiert

- Rücken und Umrandung:
100% Polyester-Trikot



Fashion Art. 277

- middle section and side sections:
100% polyester knitted fabric

- backside and border:
100% polyester-tricot

Art.-Nr.	Farbe	Größe	Ausführung	VPE
27771618	grau	SAB 2	Vordersitzgarnitur	18
27775918	grau	SAB 2 Vario plus	Set 15-teilig	10
27771609	beige	SAB 2	Vordersitzgarnitur	18
27775909	beige	SAB 2 Vario plus	Set 15-teilig	10



Kompatibel mit
Seitenairbag
www.tuv.com
ID: 000027113

SITZBEZÜGE - SEAT-COVERS



09 beige

18 grau



Prestige



Prestige Art. 280

- Mittelteil und Seitenteile:
100% Polyester, atmungsaktives Abstandsgewirke
- Rücken und Umrandung:
100% Polyester-Trikot, gestrickt



Prestige Art. 280

- middle section and side sections:
100% polyester, breathable mesh fabric
- backside and border:
100% polyester-tricot, woven

Art.-Nr.	Farbe	Größe	Ausführung	VPE
28075902	graphit	SAB 2 Vario plus	Set 15-teilig	10



02 graphit



Flower



Flower Art. 258

- **Mittelteil und Seitenteile:**
100% Polyester, atmungsaktives
Abstandsgewirke

- **Rücken und Umrandung:**
100% Polyester-Trikot



Flower Art. 258

- **middle section and side sections:**
100% polyester, breathable
mesh fabric

- **backside and border:**
100% polyester-tricot

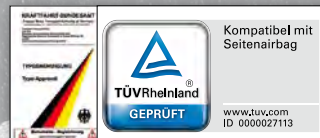

Art.-Nr.	Farbe	Größe	Ausführung	VPE
25874922	pink	SAB 1 Vario plus	Set 17-tlg.	10



22 pink

SITZBEZÜGE - SEAT-COVERS



Texas



Texas Art. 285

- Mittelteil und Seitenteile:
100% Echtleder
- Rücken und Umrandung:
100% Polyurethan
- Extra dicke Kaschierung



Texas Art. 285

- middle section and side sections:
100% genuine leather
- backside and border:
100% polyurethane
- extra thick lamination



Art.-Nr.	Farbe	Größe	Ausführung	VPE
28571504	schwarz	Vordersitzgarnitur SAB 1	6-teilig	6
28573204	schwarz	Rücksitzgarnitur Vario plus	11-teilig	6



04 schwarz



Butterfly



Butterfly Art. 227

- Mittelteil und Seitenteile:
100% Polyester Soft-Velours

- Rücken und Umrandung:
100% Polyester-Trikot



Butterfly Art. 227

- middle section and side sections:
100% polyester soft-velours

- backside and border:
100% polyester-tricot

Art.-Nr.	Farbe	Größe	Ausführung	VPE
22774905	blau	SAB 1 Vario plus	Set 17-tlg.	10
22774912	rot	SAB 1 Vario plus	Set 17-tlg.	10
22774918	grau	SAB 1 Vario plus	Set 17-tlg.	10
22774922	pink	SAB 1 Vario plus	Set 17-tlg.	10



05 blau

SITZBEZÜGE - SEAT-COVERS



22 pink



12 rot



18 grau



Sylt



Sylt Art. 257

- **Mittelteil:**
strapazierfähiges Gewebe,
100% Polyester

- **Seitenteile, Rücken und Umrandung:**
100% Polyester-Trikot,
schaumstoffkaschiert



Sylt Art. 257

- **Middle-section:**
Hard-wearing fabric,
100 % polyester

- **Side sections, backside and border:**
100% polyester-tricot,
laminated with foam



Kompatibel mit
Seitenairbag
www.tuv.com
ID 0000027113

Art.-Nr.	Farbe	Größe	Ausführung	VPE
25771604	schwarz	SAB 2	Vordersitzg. 4-tlg.	18
25775904	schwarz	SAB 2 Vario plus	Set 15-tlg.	10



04 schwarz



SITZBEZÜGE - SEAT-COVERS



Malta



Malta Art. 256

- **Mittelteil:**
strapazierfähiges Gewebe,
100% Polyester

- **Seitenteile, Rücken und Umrandung:**
100% Polyester-Trikot,
schaumstoffkaschiert



Malta Art. 256

- **Middle-section:**
Hard-wearing fabric,
100 % polyester

- **Side sections, backside and border:**
100% polyester-tricot,
laminated with foam



Kompatibel mit
Seitenairbag
www.tuv.com
ID: 0000027113

Art.-Nr.	Farbe	Größe	Ausführung	VPE
25671618	grau	SAB 2	Vordersitzg. 4-tlg.	18
25675918	grau	SAB 2 Vario plus	Set 15-tlg.	10



18 grau



Gecko



Gecko Art. 248

- Mittelteil und Seitenteile:
100% Polyester, atmungsaktives Abstandsgewirke
- Rücken und Umrandung:
100% Polyester-Trikot
- von „Hohensteiner Institute“ auf Atmungsaktivität und Ventilation getestet *



Gecko Art. 248

- middle section and side sections:
100% polyester, breathable mesh fabric
- backside and border:
100% polyester-tricot
- tested from „Hohensteiner Institute“ regarding breathability and ventilation *

Art.-Nr.	Farbe	Größe	Ausführung	VPE
24874805	blau	SAB 1 Vario	Set 11-tlg.	10
24874813	grün	SAB 1 Vario	Set 11-tlg.	10
24874818	grau	SAB 1 Vario	Set 11-tlg.	10
24874819	gelb	SAB 1 Vario	Set 11-tlg.	10
24874822	pink	SAB 1 Vario	Set 11-tlg.	10



13 grün



19 gelb



05 blau



18 grau



22 pink



Exclusive



Exclusive Art. 263

- Mittelteil und Seitenteile:
100% Polyester, moderne
Lederlook-Optik
- extra dicke Kaschierung
- Rücken und Umrandung:
100% Polyester-Trikot



Exclusive Art. 263

- middle section and side section:
100% polyester, modern
leather-look
- extra thick lamination
- backside and border:
100% polyester-tricot

Art.-Nr.	Farbe	Größe	Ausführung	VPE
26374905	blau	SAB 1 Vario plus	Set 17-tlg.	10
26374912	rot	SAB 1 Vario plus	Set 17-tlg.	10
26374918	grau	SAB 1 Vario plus	Set 17-tlg.	10



18 grau

SITZBEZÜGE - SEAT-COVERS



05 blau



12 rot



Dakar



Dakar Art. 225

- Mittelteil und Seitenteile:
100% Polyester, moderne
Lederlook-Optik

- Rücken und Umrandung:
100% Polyester-Trikot



Dakar Art. 225

- middle section and side sections:
100% polyester, modern
leather-look

- backside and border:
100% polyester-tricot

Art.-Nr.	Farbe	Größe	Ausführung	VPE
22574901	anthrazit	SAB 1 Vario plus	Set 17-tlg.	8
22574906	braun	SAB 1 Vario plus	Set 17-tlg.	8
22574909	beige	SAB 1 Vario plus	Set 17-tlg.	8
22574918	grau	SAB 1 Vario plus	Set 17-tlg.	8



O6 braun

SITZBEZÜGE - SEAT-COVERS



09 beige



18 grau



01 anthrazit



Super Speed



Super-Speed Art. 229

- Mittelteil und Seitenteile:
Abstandsgewirke kombiniert mit
Polyester-Trikot

- Rücken und Umrandung:
100% Polyester-Trikot



Super-Speed Art. 229

- middle section and side sections:
mesh fabric combined with
polyester-tricot

- backside and border:
100% polyester-tricot

Art.-Nr.	Farbe	Größe	Ausführung	VPE
22974805	blau	SAB 1 Vario	Set 11-tlg.	10
22974812	rot	SAB 1 Vario	Set 11-tlg.	10
22974813	grün	SAB 1 Variko	Set 11-tlg.	10
22974818	grau	SAB 1 Vario	Set 11-tlg.	10



13 grün

SITZBEZÜGE - SEAT-COVERS



18 grau



12 rot



05 blau



Classic



Classic Art. 242

- Mittelteil und Seitenteile:
100% Polyester, Microfaser-Velours

- Rücken und Umrandung:
100% Polyester-Trikot



Classic Art. 242

- middle section and side sections:
100% polyester, microfibre velours

- backside and border:
100% polyester-tricot

Art.-Nr.	Farbe	Größe	Ausführung	VPE
24271518	grau	SAB 1	Vordersitzg. 6-tlg.	20
24274918	grau	SAB 1 Vario plus	Set 17-tlg.	10



SITZBEZÜGE - SEAT-COVERS



18 grau



Vesuv



Vesuv Art. 234

- Mittelteil und Seitenteile:
100% Polyester
- Rücken und Umrandung:
100% Polyester-Trikot
- Dezente Farbkombination



Vesuv Art. 234

- middle section and side sections:
100% polyester
- backside and border:
100% polyester-tricot
- classical look



Kompatibel mit Seitensairbag

www.tuv.com
ID: 0000027113

Art.-Nr.	Farbe	Größe	Ausführung	VPE
23471501	anthrazit	SAB 1	Vordersitzg. 6-tlg.	20
23474901	anthrazit	SAB 1 Vario plus	Set 17-tlg.	10



01 anthrazit





Elegance



Elegance Art. 252

- Mittelteil und Seitenteile:
100% Polyester - Lederlook-Optik

- Rücken und Umrandung:
100% Polyester-Trikot



Elegance Art. 252

- middle section and side sections:
100% polyester - leather-look

- backside and border:
100% polyester-tricot

Art.-Nr.	Farbe	Größe	Ausführung	VPE
25274905	blau	SAB 1 Vario plus	Set 17-tlg.	10
25274909	beige	SAB 1 Vario plus	Set 17-tlg.	10
25274918	grau	SAB 1 Vario plus	Set 17-tlg.	10



05 blau

SITZBEZÜGE - SEAT-COVERS



09 beige



18 grau



Arizona



Arizona Art. 341

- Mittelteil und Seitenteile:
PU - Kunstleder

- Rücken und Umrandung:
100% Polyester-Trikot,
schaumstoffkaschiert

- Mittelteil gesteppt



Arizona Art. 341

- middle and side sections:
PU - imitation leather

- backside and border:
100 % Polyester-tricot,
laminatd with foam

- middle section quilted



Kompatibel mit
Seitenairbag

www.tuv.com
ID: 0000027113

Art.-Nr.	Farbe	Größe	Ausführung	VPE
34171604	schwarz	SAB 2	Vordersitzg. 4-tlg.	16
34175904	schwarz	SAB 2 Vario plus	Set 15-tlg.	8



04 schwarz



SITZBEZÜGE - SEAT-COVERS



Wave



Wave Art. 228

- **Mittelteil:**
100% Polyester - Lederlook-Optik
- **Seitenteile:**
100% Polyester Abstandsgewirke
- **Rücken und Umrandung:**
100% Polyester-Trikot



Wave Art. 228

- **middle section:**
100% polyester - leather-look
- **side sections:**
100% polyester mesh-fabric
- **backside and border:**
100% polyester-tricot



Kompatibel mit Seitensairbag

www.tuv.com
ID: 0000027113

Art.-Nr.	Farbe	Größe	Ausführung	VPE
22874809	beige	SAB 1 Vario	Set 11-tlg.	10
22874818	grau	SAB 1 Vario	Set 11-tlg.	10



18 grau

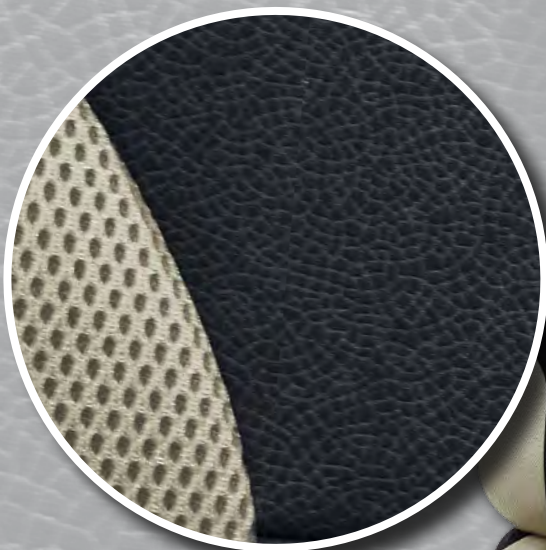

09 beige



Colori



Colori Art. 388

- Mittelteil und Seitenteile:
100% Polyester, gewirkt, kaschiert

- Rücken und Umrandung:
100% Polyester-Trikot



Colori Art. 388

- middle section and side sections:
100% polyester, knitted, laminated

- backside and border:
100% polyester-tricot

Art.-Nr.	Farbe	Größe	Ausführung	VPE
38874805	blau	SAB 1 Vario	Set 11-tlg.	10
38874812	rot	SAB 1 Vario	Set 11-tlg.	10
38874818	grau	SAB 1 Vario	Set 11-tlg.	10



12 rot

SITZBEZÜGE - SEAT-COVERS



18 grau

Colori



05 blau



Turbo



Turbo Art. 201

- Mittelteil und Seitenteile:
100% Polyester-Trikot, kaschiert

- Rücken und Umrandung:
100% Polyester-Trikot



Turbo Art. 201

- middle section and side sections:
100% polyester-tricot, laminated

- backside and border:
100% polyester-tricot

Art.-Nr.	Farbe	Größe	Ausführung	VPE
20174805	blau	SAB 1 Vario	Set 11-tlg.	10
20174812	rot	SAB 1 Vario	Set 11-tlg.	10
20174817	weiß	SAB 1 Vario	Set 11-tlg.	10
20174818	grau	SAB 1 Vario	Set 11-tlg.	10



05 blau



17 weiss



12 rot



18 grau



Carbon



Carbon Art. 335

- Mittelteil und Seitenteile:
Strapazierfähiger Polyester-Stoff
- Rücken und Umrandung:
100% Polyester-Trikot
- Moderne Carbon-Optik



Carbon Art. 335

- middle section and side sections:
hard-wearing polyester-fabric
- backside and border:
100% polyester-tricot
- stylish carbon-look

Art.-Nr.	Farbe	Größe	Ausführung	VPE
33574803	silber	SAB 1 Vario	Set 11-tlg.	8
33574804	schwarz	SAB 1 Vario	Set 11-tlg.	8
33574805	blau	SAB 1 Vario	Set 11-tlg.	8
33574812	rot	SAB 1 Vario	Set 11-tlg.	8

SITZBEZÜGE - SEAT-COVERS



03 silber



04 schwarz



12 rot



05 blau



Kreta



Kreta Art. 204

- **Mittelteil:**
100% Polyester, Microfaser-Velours
- **Seitenteile:**
PU - Kunstleder
- **Rücken und Umrandung:**
100% Polyester-Trikot,
schaumstoffkaschiert



Kreta Art. 204

- **middle section:**
100% polyester, microfibre velours
- **side sections:**
PU - imitation leather
- **backside and border:**
100% polyester-tricot,
laminated with foam



Kompatibel mit
Seitenairbag

www.tuv.com
ID: 0000027113

Art.-Nr.	Farbe	Größe	Ausführung	VPE
20471618	grau	SAB 2	Vordersitzg. 4-tlg.	16
20475918	grau	SAB 2 Vario plus	Set 15-tlg.	8



18 grau

SITZBEZÜGE - SEAT-COVERS



Elba



Elba Art. 207

- Mittelteil:
Jaquard gewebt, 100% Polyester
- Seitenteile:
PU - Kunstleder
- Rücken und Umrandung:
100% Polyester-Trikot,
schaumstoffkaschiert
- Dezentere Farbkombination



Elba Art. 207

- middle section:
jaquard-woven, 100% polyester
- side sections:
PU - imitation leather
- backside and border:
100% polyester-tricot,
laminated with foam
- classical look



Kompatibel mit
Seitenairbag

www.tuv.com
ID: 000027113

Art.-Nr.	Farbe	Größe	Ausführung	VPE
20771601	anthrazit	SAB 2	Vordersitzg. 4-tlg.	16
20775901	anthrazit	SAB 2 Vario plus	Set 15-tlg.	8



01 anthrazit





Sydney



Sydney Art. 261

- **Mittelteil:** 100% Polyester - atmungsaktives Abstandsgewirke
- **Seitenteile, Rücken und Umrandung:** 100% Polyester, moderne Lederlook-Optik
- von „Hohensteiner Institute“ auf Atmungsaktivität und Ventilation getestet *



Sydney Art. 261

- **middle section:** 100% polyester, breathable mesh fabric
- **side sections, backside and border:** 100% polyester, modern leather-look
- tested from „Hohensteiner Institute“ regarding breathability and ventilation *

Art.-Nr.	Farbe	Größe	Ausführung	VPE
26174802	graphit	SAB 1 Vario	Set 11-tlg.	8
26174804	schwarz	SAB 1 Vario	Set 11-tlg.	8
26174809	beige	SAB 1 Vario	Set 11-tlg.	8



09 beige

SITZBEZÜGE - SEAT-COVERS



04 schwarz



02 graphit



Profi 1, 2, 3, 4 Art. 300

- Mittelteil:

Profi 1-3: 100% Polyester
Profi 4 : Kunstleder

- Seitenteile, Rücken und Umrandung: 100% Polyester

- Nicht geeignet für Fahrzeuge mit Seitenairbag!

Unsere Sitzbezugsets „Profi“ sind passend für verschiedene Transporter und Kombis. Für den Sicherheitsgurt ist im Bezug für den Doppelsitz ein Reißverschluss eingearbeitet, damit dieser problemlos erreichbar und nutzbar ist.



Profi 1, 2, 3, 4 Art. 300

- middle section:

Profi 1-3: 100% polyester
Profi 4 : imitation-leather

- side sections, backside and border: 100% polyester

- not suitable for vehicles with sideairbag!

Our seat-cover sets „Profi“ fit for various vans and transporters. In order to ensure the proper and easy use of the seat-belt, a zipper is integrated in the seat-cover for the double seat.

Modelltable für / Table of sizes for					
Citroen	Berlingo, Jumper, Jumpy, Nemo ²	Fiat	Ducato, Fiorino ² , Scudo	Ford	Fiesta Courier ² , Transit, Transit Custom, Tourneo Tourneo Custom
Hyundai	H1, NV200, NV400 ²	Iveco	Daily	Mercedes	Sprinter ¹ , Vito
Nissan	Interstar, Kubistar ² , Primastar	Opel	Combo ² , Movano ab 98 - 2010, Movano ab 2010 ² , Vivaro	Peugeot	Bipper ² , Boxer, Expert, Partner
Renault	Kangoo ² , Mascott, Master ab 98 - 2010, Master ab 2010 ² , Rapid ² , Trafic	Seat	Inca ²	Toyota	Hiace, Pro Ace ²
Volkswagen	Caddy ² , Crafter ¹ , LT, T4, T5				

Profi 2

Art.-Nr.	Farbe	Größe	Ausführung	VPE
30071905	blau	Universal	1 x Einzelsitz 1 x Doppelsitz	15
30070005	blau	Universal	2 x Einzelsitz	20
30073505	blau	Universal	1 Doppelsitz hinten	20
30070105	blau	Universal	1 Einzelsitz hinten	30
30073005	blau	Universal	3er Bank hinten	15

1 = nur Einzelsitz/Doppelsitz passend / only suitable for single-seat/double-seat
2 = nur 2x Einzelsitz passend / only for 2 single seats suitable

SITZBEZÜGE - SEAT-COVERS



Einzelsitz/Doppelsitz vorne
Single-seat / double-seat front



2x Einzelsitz vorne
2x single seat front



3er Sitzbank hinten
3 seat bench rear



Einzelsitz hinten
single seat rear



Doppelsitz hinten
double seat rear



Profi 1

Art.-Nr.	Farbe	Größe	Ausführung	VPE
30071912	rot	Universal	1 x Einzelsitz 1 x Doppelsitz	15
30070012	rot	Universal	2 x Einzelsitz	20



Profi 3

Art.-Nr.	Farbe	Größe	Ausführung	VPE
30071918	grau	Universal	1 x Einzelsitz 1 x Doppelsitz	15
30070018	grau	Universal	2 x Einzelsitz	20



Profi 4

Art.-Nr.	Farbe	Größe	Ausführung	VPE
30071904	schwarz	Universal	1 x Einzelsitz 1 x Doppelsitz	15
30070004	schwarz	Universal	2 x Einzelsitz	20





Milano Art. 247

- 100% Polyester
- Jacquard-Gewirke kombiniert mit Lederoptik
- Einfache und schnelle Montage
- Besonders strapazierfähig
- Auch für Fahrzeuge mit Seitenairbag geeignet
- Universalgröße



Milano Art. 247

- 100% polyester
- knitted jacquard-fabric combined with leather-look fabric
- easy and fast installation
- very durable
- also suitable for cars with side airbag
- universal size

Art.-Nr.	Farbe	Größe	VPE
24770005	blau	Universal	12
24770012	rot	Universal	12
24770018	grau	Universal	12

SITZAUFLEGER - SEAT-CUSHIONS



12 rot

18 grau

05 blau



Danzig Art. 297

- Moderner Sitzaufleger
- Lederimitat
- Einfache und schnelle Montage
- Besonders strapazierfähig
- Auch für Fahrzeuge mit Seitenairbag geeignet
- Universalgröße



Danzig Art. 297

- modern seat-cushion
- leather-imitation
- easy and fast installation
- very durable
- also suitable for cars with side airbag
- universal size



Art.-Nr.	Farbe	Größe	VPE
29770005	blau	Universal	10
29770012	rot	Universal	10
29770018	grau	Universal	10



12 rot



18 grau



05 blau



Schutzbezug „Action Sport“ Art. 31671304

- Aus Nylon
- Für Hobby und Beruf
- Universell passend
- Mit integrierten Staufächern
- Nicht geeignet für Fahrzeuge mit Seitenairbag!



Protective seat-cover „Action Sport“

Art. 31671304

- hard-wearing nylon material
- for leisure and work
- one size fits all
- with integrated pockets
- not suitable for vehicles with side-airbag!



Art.-Nr.	Größe	Einheit	Farbe	VPE
31671304	K	VS	schwarz	40



Kotflügelschoner Art. 44010000

- Kunstleder mit Schaumstoff kaschiert
- Mit durchgehendem Magnetstreifen
- Besonders lackschonend
- Farbe: schwarz



Fender protector Art. 44010000

- imitation-leather with foam lamination
- with continuous magnetic-stripe
- prevents varnished surfaces from being scratched
- colour: black



Art.-Nr.	Abmessungen	Farbe	VPE
44010000	ca. 105 x 63 cm	schwarz	20



Universal-Schutzdecke Art. 21773004

- Zur Schonung der Rücksitze
- Material: Kunstleder
- Einfache Montage
- Einfache Reinigung



Universal protection cover Art. 21773004

- universal back seat protection cover
- material: imitation leather
- easy installation
- easy to clean

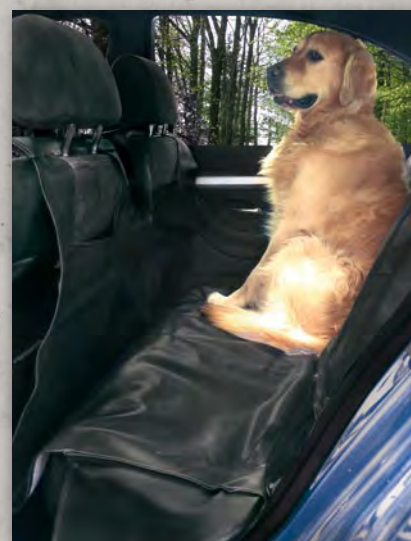

Art.-Nr.	Größe	Farbe	VPE
21773004	Universal	schwarz	10



Art.-Nr.	Größe	Einheit	Farbe	VPE
21871304	K	VS	schwarz	1
21870904	K + SAB	VS	schwarz	1
21871404	Uni	DS	schwarz	1
21871301	K	VS	anthrazit	1
21870901	K + SAB	VS	anthrazit	1
21871401	Uni	DS	anthrazit	1



Schutzbezug „Hobby“ Art. 218

- Gefertigt aus besonders strapazierfähigem Stoff, 100% Polyester
- Auch für Fahrzeuge mit Seitenairbag lieferbar (inklusive TÜV-Laborbericht)
- Auch erhältlich als Doppelsitz (DS)



Protective seat-cover „Hobby“ Art. 218

- made of very sturdy fabric, 100% Polyester
- also available for seats with side-airbag (including TÜV-report)
- also available as double-seat (DS)



Art.-Nr.	Größe	Einheit	Farbe	VPE
21771304	K	VS	schwarz	20
21770904	K + SAB	VS	schwarz	20
21771404	Uni	DS	schwarz	1



Werkstattschoner Art. 217

- Kunstleder
- Für Hobby und Beruf
- Universell passend
- Auch für Fahrzeuge mit Seitenairbag lieferbar (inkl. TÜV-Laborbericht)
- Auch erhältlich als Doppelsitz (DS)



Workshop seat-cover Art. 217

- imitation leather
- for leisure and work
- one size fits all
- also available for seats with side-airbag (including TÜV-report)
- also available as double-seat (DS)



Art.-Nr.	Größe	Einheit	Farbe	VPE
21670904	K + SAB	VS	schwarz	20
21671404	Uni	DS	schwarz	1



Werkstattschoner PREMIUM Art. 216

- Kunstleder
- Für Hobby und Beruf
- Universell passend
- Auch für Fahrzeuge mit Seitenairbag lieferbar (inkl. TÜV-Laborbericht)
- Auch erhältlich als Doppelsitz (DS)



Workshop seat-cover PREMIUM Art. 216

- imitation leather
- extra heavy and hard-wearing quality
- tested for harmful substances
- for leisure and work
- one size fits all, also for seats with side-airbag (including TÜV-report)

Neu - New

SIEBDRUCK / SCREEN PRINTING

Egal ob Werkstattschoner, Reifentaschen, diverse Sicherheitsartikel oder Schmutzfänger – jetzt können Sie all diese Artikel mit Ihrem Logo versehen lassen. Fragen Sie uns, wir unterbreiten Ihnen gerne ein attraktives Angebot – auch bei geringen Stückzahlen.

No matter if it is workshop seat-covers, tire bags, various safety-items or mud-flaps – now you can have your logo printed onto all of these products. Ask us, we will gladly give you an attractive quotation – even for small quantities.

NEU +++ NEW +++NEU +++ NEW +++NEU +++ NEW +++NEU +++ NEW +++NEU +++ NEW +++NEU +++ NEW +++NEU



SICHERHEITZUBEHÖR / SAFETY-ACCESSOIRES

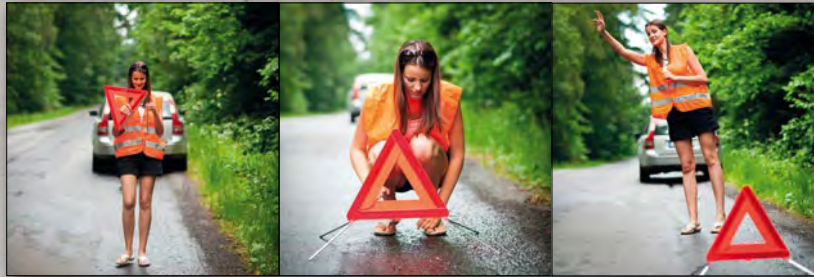

Kombitasche „Kompakt plus“ Art. 43999412

- Aus Nylon-Gewebe
- Ca. 23,5 x 16,5 x 9,5 cm
- Separates Fach für Warnweste und Warndreieck
- **Inklusive Klett zur einfachen Befestigung**
- Verbandmaterial nach DIN 13164:2014
- EURO-Warndreieck, amtlich geprüft
- Sicherheitsweste nach DIN EN ISO 20471



Combi bag „Kompakt plus“ Art. 43999412

- bag made of nylon-fabric
- approx. 23,5 x 16,5 x 9,5 cm
- **including velcro on the backside for better storage**
- dressing material of the first-aid-kit according to DIN 13164:2014
- EURO warning triangle officially tested and approved
- warning vest according to DIN EN ISO 20471

Neu - New

INHALT / CONTENT

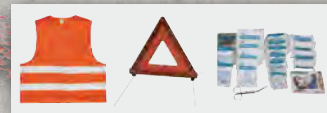

Art.-Nr.	Abmessungen	Farbe	VPE
43999412	ca. 23,5 x 16,5 x 9,5 cm	rot	20



Art.-Nr.	Größe	Farbe	VPE
43940200	44 x 5,5 x 3,5 cm	rot	20



Warndreieck „Euro Mini“ Art. 43940200

- Im Kunststoffköcher
- Ca. 44, x 5,5 x 3,5 cm
- Geprüft und zugelassen
- Passend auch für dafür vorgesehene Halter in vielen KFZ



Warning triangle „Euro Mini“ Art. 43940200

- in a plastic receptacle
- approx. 44 x 5,5 x 3,5 cm
- tested and approved
- also fits into the tray destined of most vehicles



Art.-Nr.	Größe	Farbe	VPE
43940300	23,5 x 6,8 x 5,5 cm	rot	10



Warndreieck „Kompakt“ Art. 43940300

- Im Kunststoffköcher
- Ca. 23,5 x 6,8 x 5,5 cm
- Geprüft und zugelassen
- Passend auch für dafür vorgesehene Halter in vielen KFZ



Warning triangle „Kompakt“ Art. 43940300

- in a plastic receptacle
- approx. 23,5 x 6,8 x 5,5 cm
- tested and approved
- also fits into the tray destined of most vehicles



Art.-Nr.	Größe	Farbe	VPE
43910000	L	orange	100
43910100	XXL	orange	100
43919900	Kind	orange	80
43910019	L	gelb	100



Sicherheitsweste Art. 4391

- Nach DIN EN ISO 20471 (nur Größe L / XXL)
- Aus Polyester-Stoff
- doppelter Reflexionsstreifen
- praktische Klettverschlüsse
- **Ausrüstungspflicht in vielen EU-Staaten**



Safety vest Art. 4391

- according to DIN EN ISO 20471 (size L / XXL only)
- made of polyester-fabric
- two reflective stripes
- convenient fasteners noch-and-loop
- **statutory requirement in many EU countries**



Verbandkasten Art. 43920005

- Aus bruchsicherem Kunststoff
- Inhalt nach DIN 13164:2014
- Eingeschrumpft in Folie
- Inklusive Broschüre mit Erste-Hilfe-Hinweisen
- Eingeschrumpft in Folie



First-aid kit Art. 43920005

- box made of breakproof plastic material
- content according to DIN 13164:2014
- shrink-packed
- including brochure with first-aid instructions
- shrink-packed



Art.-Nr.	Abmessungen	Farbe	VPE
43920005	ca. 25,5 x 17,4 x 7,8 cm	blau	20



Verbandtaschen Art. 4393

- Aus Nylon-Gewebe
- Inhalt nach DIN 13164:2014
- Eingeschrumpft in Folie
- Inklusive Broschüre mit Erste-Hilfe-Hinweisen
- **Inklusive Klett zur einfachen Befestigung**
- Eingeschrumpft in Folie



First-aid bags Art. 4393

- bag made of nylon-fabric
- content according to DIN 13164:2014
- shrink-packed
- including brochure with first-aid instructions
- **including notch-and-loop fastening system on the backside for better storage**
- shrink-packed



Art.-Nr.	Abmessungen	Farbe	VPE
43930004	ca. 22,5 x 13 x 6,5 cm	schwarz	20
43930012	ca. 22,5 x 13 x 6,5 cm	rot	20



Motorradverbandtasche Art. 43939904

- Aus Nylon-Gewebe
- Inhalt nach DIN 13167:2014
- Eingeschrumpft in Folie
- Inklusive Broschüre mit Erste-Hilfe-Hinweisen
- Eingeschrumpft in Folie



Motorbike first-aid kit Art. 43939904

- bag made of nylon-fabric
- content according to DIN 13167:2014
- including brochure with first-aid instructions
- shrink-packed



Art.-Nr.	Abmessungen	Größe	VPE
43939904	ca. 18 x 11 x 5 cm	schwarz	20

INHALT / CONTENT

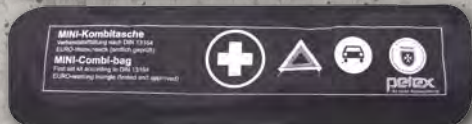
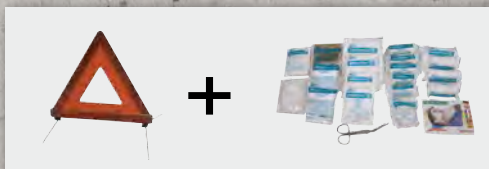

Art.-Nr.	Abmessungen	Farbe	VPE
43999904	ca. 44 x 7,5 x 9 cm	schwarz	20
43999912	ca. 44 x 7,5 x 9 cm	rot	20

INHALT / CONTENT

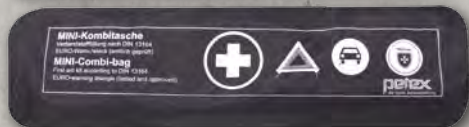
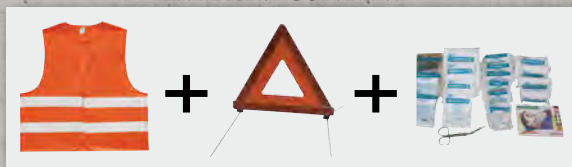

Art.-Nr.	Abmessungen	Farbe	VPE
43999704	ca. 44 x 7,5 x 9 cm	schwarz	20
43999712	ca. 44 x 7,5 x 9 cm	rot	20



Inhalt:

- 1 x Schere
- 1 x Verbandpäckchen
- 1 x Fixierbinde, 8 cm
- 1 x Fixierbinde, 6 cm
- 1 x Heftpflaster
- 2 x Wundpflaster, 10 cm
- 12 x Pflasterstrips
- 2 x Kompressen
- 2 x Erste-Hilfe Handschuhe
- 1 x Erste-Hilfe-Anleitung

Content:

- 1 x Scissors
- 1 x Standard dressing
- 1 x Conforming bandage, 8 cm
- 1 x Conforming bandage, 6 cm
- 1 x Adhesive tape
- 2 x Adhesive plasters, 10 cm
- 12 x Plaster strips
- 2 x Wound dressings
- 2 x Disposable gloves
- 1 x First-aid guidelines

Art.-Nr.	Abmessungen	Farbe	VPE
43930112	ca. 14 x 10 x 5 cm	rot	40



Kombitasche Art. 439999

- Aus Nylon-Gewebe
- Ca. 44 x 7,5 x 9 cm
- **Inklusive Klett zur einfachen Befestigung**
- Verbandmaterial nach DIN 13164:2014
- EURO-Warndreieck, amtlich geprüft und zugelassen
- Eingeschrumpft in Folie



Combi-bag Art. 439999

- bag made of nylon-fabric
- approx. 44 x 7,5 x 9 cm
- **including velcro on the backside for better storage**
- dressing material according to DIN 13164:2014
- EURO warning triangle officially tested and approved
- shrink-packed



Kombitasche plus Art. 439997

- Aus Nylon-Gewebe
- Ca. 44 x 7,5 x 9,0 cm
- **Inklusive Klett zur einfachen Befestigung**
- Verbandmaterial nach DIN 13164:2014
- EURO-Warndreieck, amtlich geprüft
- Sicherheitsweste nach DIN EN ISO 20471
- Eingeschrumpft in Folie



Combi-bag plus Art. 439997

- bag made of nylon-fabric
- **including velcro on the backside for better storage**
- approx. 44 x 7,5 x 9 cm
- dressing material of the first-aid-kit according to DIN 13164:2014
- EURO warning triangle officially tested and approved
- safety vest according to DIN EN ISO 20471
- shrink-packed



Freizeitverbandtasche Art. 43930112

- Aus Nylon-Gewebe
- Ideal für Freizeit und Sport
- **Inklusive Klettbändern an der Rückseite zum sicheren Befestigen**
- **eingeschrumpft in Folie**



Leisure first-aid kit Art. 43930112

- bag made of nylon fabric
- ideal for leisure and sports
- **including velcro stripes for easy fixation**
- **shrink-packed**



Feuerlöscher Art. 4397

- Entspricht der DIN EN3
- Zuverlässiger ABC-Dauerdrucklöscher mit Manometer
- Behälter aus hochwertigem Stahlblech und witterungsbeständiger Pulverbeschichtung
- Inklusive praktischer Halterung
- Ideal für's Auto, im Haushalt oder Büro



Fire Extinguisher Art. 4397

- according to DIN EN3
- reliable ABC-extinguisher with constant pressure incl. gauge
- vessel made of high-quality sheet-steel; with weatherproof powder-coating
- including convenient holder
- ideal in the car, household or at the office



Art.-Nr.	Größe	VPE
43970000	1 Kg	10
43970100	2 Kg	4
43970200	6 Kg	2



Kanister Art. 4431

- Aus robustem HDPE-Kunststoff
- Mit flexiblem Auslaufrohr
- Mit UN-Zulassung für Transporte nach GGVS (d. h. es dürfen mehrere Kanister im Fahrzeug transportiert werden, jedoch ist das Bruttogewicht auf 120 Kg begrenzt)



Canister Art. 4431

- made of sturdy hdpe-material
- with flexible nozzle
- with UN-homologation for transport according to GGVS (allowance to transport several canister in a car, but with a maximum gross weight of 120 kg)

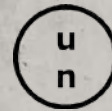

Art.-Nr.	Größe	Abmessungen	VPE
44310504	5 Liter	260 x 145 x 270 mm	20
44311004	10 Liter	290 x 180 x 320 mm	12
44312004	20 Liter	362 x 220 x 387 mm	4



Auto-Entfeuchter „Pingi“ Art. LV-A300-DE

- verhindert das Beschlagen der Scheiben im Auto
- wiederaufladbar durch trocknen in der Mikrowelle
- mit integriertem, patentiertem Feuchtigkeitsindikator
- Bindet die Feuchtigkeit im Inneren
- tropft nicht



Car dehumidifier „Pingi“ Art. LV-A300-DE

- Prevents fogging of the cars' windows
- Rechargeable by drying in the microwave
- with integrated, patented moisture-indicator
- absorbs the moisture inside
- does not drip



Art.-Nr.	Abmessungen	Einheit	VPE
LV-A300-DE	ca. 17 x 11,5 x 3 cm	Display	8

Jetzt in 2 Qualitäten erhältlich!
Available in 2 qualities now!



Art.-Nr.	Abmessungen	Einheit	Qualität	VPE
48110200	150 x 70 cm	Stück	Thermo	25
48110300	180 x 85 cm	Stück	Thermo	25
48110400*	150 x 100 cm	Stück	Thermo	25
48110500*	180 x 85 cm	Stück	Premium	40
48110600*	150 x 100 cm	Stück	Premium	40

* Passend für Fahrzeuge mit geteilten Seitenscheiben
suitable for vehicles with split side windows





Art.-Nr.	Abmessungen	Einheit	VPE
44140004	200 x 20 x 40 cm	Stück	10





Art.-Nr.	Farbe	Einheit	VPE
44130004	schwarz	Stück	10

-  **Frontscheibenabdeckung „Thermo“** Art. 4811
- Der Winter- und Sommerschutz für die Windschutzscheibe
 - Verhindert Vereisung der PKW-Frontscheibe und das festfrieren der Scheibenwischer
 - Reduziert im Sommer die PKW-Innenraumtemperatur
 - Einfache Befestigung, inklusive Lasche zum Festklemmen in der Tür

-  **Windshield-cover „Thermo“** Art. 4811
- protection for the windshield during summer- and wintertime
 - keeps the windshield from icing and the wiper blades from freezing in
 - helps to reduce the temperature inside the car during summertime
 - easy installation, incl. flap for clamping the cover in the door

-  **Skisack** Art. 44140004
- Mit praktischen Tragegriffen / Schultergurt
 - Mit Reißverschluss zum Öffnen und Schließen
 - Außengurt zur kompakten Fixierung der Ski
 - Strapazierfähiges, innen beschichtetes Polyester
 - Innen- und Außenseite wasserabweisend
 - Volumen ca. 160 L

-  **Ski-bag** Art. 44140004
- with convenient carrying handle/shoulder belt
 - with zipper closing
 - outer belt for a compact fixing of the ski
 - hard-wearing polyester with internal coating
 - inside and outside water-repellent
 - capacity approx. 160 liter

-  **Reifentaschenset „PREMIUM“** Art. 44130004
- Einfach, schnell und bequem zu montieren
 - Schwere, strapazierfähige Polyester-Qualität
 - Schutz vor Verschmutzung
 - Passend für alle gängigen Lagervorrichtungen
 - Verlängert die Reifenlebensdauer

-  **Set of tire-bags „PREMIUM“** Art. 44130004
- easy, fast and convenient installation
 - heavy, hard-wearing polyester-material
 - protects your clothes and car's trunk from dirt
 - suitable for all common tire storing-devices
 - helps to extend the tires lifecycle



Abschleppseil 3000 Art. 43191805

- Ausführung mit 2 Karabinerhaken
- Zugkraft: 3.000 Kg
- Material: 80% PP, 20% PE
- inklusive roter Warnflagge



Tow-rope 3000 Art. 43191805

- with 2 carabiner hooks
- max. traction 3.000 kg
- material: 80% PP, 20% PE
- including red warning flag



Art.-Nr.	Farbe	VPE
43191805	blau	16



Abschleppseil 2000 Stretch Art. 43191400

- Ausführung mit 2 Karabinerhaken
- Zugkraft: 2.000 Kg
- inklusive roter Warnflagge



Tow-rope 2000 stretch Art. 43191400

- with 2 carabiner hooks
- max. traction 2.000 kg
- including red warning flag



Art.-Nr.	Farbe	VPE
43191400	orange	16



Abschleppseil Art. 43191505

- Ausführung mit 2 Schäkkel
- Zugkraft: 3.000 Kg
- Material: 80% PP, 20% PE
- inklusive roter Warnflagge



Tow-rope Art. 43191505

- with 2 shackles
- max. traction 3.000 kg
- material: 80% PP, 20% PE
- including red warning flag



Art.-Nr.	Farbe	VPE
43191505	blau	16



Art.-Nr.	Größe	Farbe	VPE
43960104	---	schwarz	24
43960112	---	rot	24

 **Notfallhammer** Art. 439601

- Aus robustem Kunststoff
- Mit Gurtmesser
- Spitzen aus gehärtetem Stahl
- inklusive Halterung
- Lieferbar in 2 Farben

 **Emergency Hammer** Art. 439601

- made of strong plastic
- with belt cutter
- metal heads made of hardened steel
- including bracket
- available in 2 colours



Art.-Nr.	Abmessungen	Farbe	VPE
48010004	54 x 14 x 21 cm	schwarz	12

 **Kofferraumtasche** Art. 48010004

- Praktische Aufbewahrungshilfe für Werkzeug, Verbandsmaterial und diverses Zubehör
- Maße: ca. 54 x 14 x 21 cm
- Optimale Befestigung durch Klettverschluss oder mit Druckknöpfen

 **Tool-box** Art. 48010004

- convenient storage for tools, first-aid kit and other accessories
- measurements: approx. 54 x 14 x 21 cm
- ideal fixation with velcro or push-buttons



Art.-Nr.	Größe	VPE
43198200	---	10

 **Halte- und Verzurrurgurt-Set** 12-teilig Art. 43198200

- Inhalt:
- 1 Verzurrurgurt mit Ratsche, 25 mm x 5 m
- 1 Verzurrurgurt mit Ratsche und Haken, 25 mm x 5 m
- 2 Spanngurte, 25 mm x 2,5 m
- je 2 Expander, 8mm Durchmesser, Längen: 40 cm, 60 cm, 80 cm, 100 cm

 **Ratchet Tie-Down set** 12 piece Art. 43198200

- content:
- 1 tie-down strap with ratchet 25 mm x 5 m
- 1 tie-down strap with ratchet and hook 25 mm x 5 m
- 2 tie downs 25 mm x 2,5 m
- expander, 8 mm diameter, lengths: 40 cm, 60 cm, 80 cm and 100 cm (two pieces of each length)

DURACELL®

TOUGH

Die starken Helfer in allen Lebenslagen.
Leichtes, stoßfestes und spritzwassergeschütztes Aluminium-Gehäuse

Der zuverlässige Begleiter mit
Fokussierlinse für individuell
anpassbare Leuchtweite



FOCUS

FCS-1



2x AA
Batterien incl.

- 3W High Power LED
- Aluminium-Gehäuse
- Focus Funktion
- 2x AA Batterien enthalten
- Gewicht: 115g
- Leuchtdauer: ca. 1 h 30 min
- Abmessungen(cm):
17,5 / Ø 3,7 vorne / Ø 2,2 hinten

FCS-10



2x C
Batterien excl.

- 3W High Power LED
- Aluminium-Gehäuse
- Focus Funktion
- 2x C Batterien benötigt
- Gewicht: 190g
- Leuchtdauer: ca. 2h
- Abmessungen (cm):
19,0 / Ø 4,7 vorne / Ø 3,2 hinten

FCS-100



2x D
Batterien excl.

- 4W High Power LED
- Aluminium-Gehäuse
- Focus Funktion
- 2x D Batterien benötigt
- Gewicht: 315g
- Leuchtdauer: ca. 4h 15min
- Abmessungen (cm):
22,5 / Ø 5,6 vorne / Ø 4,3 hinten

- 3W High Power LED
- Aluminum body
- focus function
- 2x AA batteries included
- weight: 115 g
- endurance: approx. 1 h 30 min.
- dimensions (cm):
17,5 / Ø 3,7 front / Ø 2,2 rear

- 3W High Power LED
- Aluminum body
- focus function
- 2x C batteries not included
- weight: 190 g
- endurance: approx. 2 h
- dimensions (cm):
19,0 / Ø 4,7 front / Ø 3,2 rear

- 4W High Power LED
- Aluminum body
- focus function
- 2x D batteries not included
- weight: 315g
- endurance: approx. 4 h 15 min.
- dimensions (cm):
22,5 / Ø 5,6 front / Ø 4,3 rear



Die starken Helfer in allen Lebenslagen.
Leichtes, stoßfestes und spritzwasserge-
schütztes Aluminium-Gehäuse

MULTI: Das Multi-Talent mit
SOS- und Stroboskop-Funktion,
sowie stufenweise anpassbarer Lichtstärke.



DURACELL®

TOUGH

MULTI

MLT-1



3x AAA
Batterien incl.



MLT-10



4x AAA
Batterien incl.



MLT-100

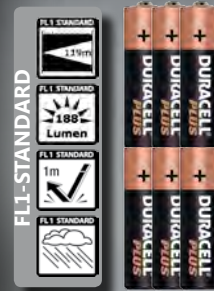

6x AAA
Batterien incl.



- 3W High Power LED
- Aluminium Gehäuse
- SOS Funktion
- Stroboskop Effekt & stufenweise anpassbare Lichtstärke
- 3x AAA Batterien enthalten
- Gewicht: 155g
- Leuchtdauer: ca. 3h 30min
- Abmessungen (cm):
13,8 / Ø 3,9 vorne / Ø 3,1 hinten

- 3W High Power LED
- Aluminum body
- SOS function, Strobe Effect & gradual adjustable light intensity
- 3x AAA batteries included
- weight: 155 g
- endurance: approx. 3h 30 min.
- dimensions (cm):
13,8 / Ø 3,9 front / Ø 3,1 rear

- 3x 3W High Power LED
- Aluminium Gehäuse
- SOS Funktion
- Stroboskop Effekt & stufenweise anpassbare Lichtstärke
- 4x AAA Batterien enthalten
- Gewicht: 255g
- Leuchtdauer: ca. 3h 30min
- Abmessungen (cm):
19,6 / Ø 4,6 vorne / Ø 3,6 hinten

- 3x 3W High Power LED
- Aluminum body
- SOS function, Strobe Effect & gradual adjustable light intensity
- 4x AAA batteries included
- weight: 255 g
- endurance: approx. 3h 30 min.
- dimensions (cm):
19,6 / Ø 4,6 front / Ø 3,6 rear

- 3x 3W High Power LED
- Aluminium Gehäuse
- SOS Funktion
- Stroboskop Effekt & stufenweise anpassbare Lichtstärke
- 6x AAA Batterien enthalten
- Gewicht: 275 g
- Leuchtdauer: ca. 4h 30min
- Abmessungen (cm):
20,7 / Ø 4,6 vorne / Ø 3,6 hinten

- 3x 3W High Power LED
- Aluminum body
- SOS function, Strobe Effect & gradual adjustable light intensity
- 6x AAA batteries included
- weight: 275 g
- endurance: approx. 4h 30 min.
- dimensions (cm):
20,7 / Ø 4,6 front / Ø 3,6 rear

DURACELL®

TOUGH

COMPACT

Die starken Helfer in allen Lebenslagen.
Leichtes, stoßfestes und spritzwasserge-
schütztes Aluminium-Gehäuse

COMPACT: Kompaktes Design
in robustem Gehäuse



CMP-3



16 Stck.



3x AAA

Batterien incl.

- 9x Super Clear LED
- Aluminium-Gehäuse
- Kompakt & robust
- 3x AAA Batterien enthalten
- 16 Stück im praktischen Thekendisplay
- Gewicht: 95g
- Leuchtdauer: ca. 10h
- Abmessungen (cm):
12,5 / Ø 3,4 vorne / Ø 2,9 hinten

- 9x Super Clear LED
- Aluminum body
- Compact and sturdy
- 3x AAA batteries included
- 16 piece in practically counter display
- weight: 95 g
- endurance: approx. 10 h
- dimensions (cm):
12,5 / Ø 3,4 front / Ø 2,9 rear

CMP-5



3x AAA

Batterien incl.

- 14x Super Clear LED
- Aluminium-Gehäuse
- Kompakt & robust
- 3x AAA-Batterien enthalten
- Gewicht: 75g
- Leuchtdauer: ca. 9h
- Abmessungen (cm):
10,3 / Ø 3,3 vorne / Ø 2,7 hinten

- 14x Super Clear LED
- Aluminum body
- Compact and sturdy
- 3x AAA batteries included
- weight: 75 g
- endurance: approx. 9 h
- dimensions (cm):
10,3 / Ø 3,3 front / Ø 2,7 rear



Die starken Helfer in allen Lebenslagen.
Leichtes, stoßfestes und spritzwasserge-
schütztes Aluminium-Gehäuse

PERSONAL: Die Taschenlampe im handli-
chen Format, die in jede Tasche passt und
somit immer griffbereit ist



DURACELL®

TOUGH

PERSONAL

KEY-1



PEN-1



SLM-1

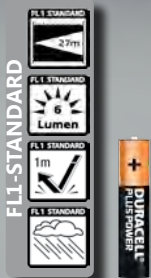

1x AAA
Batterien incl.

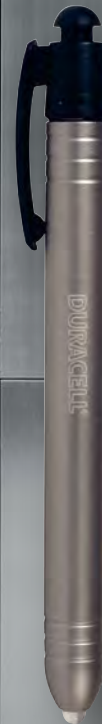

2x AAA
Batterien incl.



2x AA
Batterien incl.

- Super clear LED
- Aluminium Gehäuse
- Schlüsselanhänger
- 1x AAA Batterie enthalten
- 20 Stück im praktischen Thekendisplay
- auch einzeln erhältlich
- Gewicht: 35g
- Leuchtdauer: ca. 3h 45min
- Abmessungen (cm):
10,6 / Ø 2,2 vorne / Ø 1,5 hinten

- Super Clear LED
- Sicherheitsclip
- 2x AAA-Batterien enthalten
- 20 Stück im praktischen Thekendisplay
- Gewicht: 15g
- Abmessungen (cm):
14,2 / Ø 1,2 vorne / Ø 1,8 hinten

- 3x Super clear LED
- Aluminium Gehäuse
- Schlankes Design
- 2x AA Batterien enthalten
- Gewicht: 80g
- Abmessungen (cm):
17,4 / Ø 2,7 vorne / Ø 2,0 hinten

- Super clear LED
- Aluminum body
- key chain
- 20 piece in practically counter display
- also available seperatly
- weight: 35 g
- endurance: 3 h 45 min.
- dimensions (cm):
10,6 / Ø 2,2 front / Ø 1,5 rear

- Super Clear LED
- safety clip
- 2x AAA batteries included
- 20 piece in practically counter display
- weight: 15 g
- dimensions (cm):
14,2 / Ø 1,2 front / Ø 1,8 rear

- 3x Super clear LED
- Aluminum body
- slim design
- 2x AA batteries included
- weight: 80g
- dimensions (cm):
17,4 / Ø 2,7 front / Ø 2,0 rear

DURACELL®

VOYAGER

POWER

Die ideale Taschenlampe für unterwegs. Handliche Form, kleines Gewicht und gummierte Oberfläche

POWER: Die perfekte Kombination aus Leistung und Strapazierfähigkeit - mit rutschfester Oberfläche und hoher Leuchtweite



PWR-10



4x AA
Batterien incl.



- 3W High Power LED
- Gummiertes Gehäuse
- 4x AA Batterien enthalten
- Gewicht: 160g
- Leuchtdauer: ca. 7h
- Abmessungen (cm):
18,0 / Ø 5,3 vorne / Ø 4,4 hinten

- 3W High Power LED
- rubberized body
- 4x AA batteries included
- weight: 160g
- endurance: approx. 7h
- dimensions (cm):
18,0 / Ø 5,3 front / Ø 4,4 rear



Die ideale Taschenlampe für unterwegs. Handliche Form, kleines Gewicht und gummierte Oberfläche

CLASSIC: Ideal für den Einsatz im Freien, beim Campen und Wandern - mit stoß-, rutsch- und spritzwasserfestem Gehäuse.



DURACELL®

VOYAGER

CLASSIC

CL-1



2x AA
Batterien incl.



- 3x Super clear LED
- Gummiertes Gehäuse
- Handliche Form
- 2x AA Batterien enthalten
- Gewicht: 115g
- Leuchtdauer: 21h
- Abmessungen (cm):
15,6 / Ø 4,3 vorne / Ø 2,0 hinten

- 3x Super clear LED
- rubberized body
- handy design
- 2x AA batteries included
- weight: 115g
- endurance: approx. 21 h
- dimensions (cm):
15,6 / Ø 4,3 front / Ø 2,0 rear

CL-10



2x D
Batterien excl.



- 5x Super clear LED
- Gummiertes Gehäuse
- Handliche Form
- 2x D Batterien benötigt
- Gewicht: 290g
- Leuchtdauer: 68h
- Abmessungen (cm):
21,1 / Ø 6,5 vorne / Ø 3,0 hinten

- 5x Super clear LED
- rubberized body
- handy design
- 2x D batteries not included
- weight: 290g
- endurance: approx. 68 h
- dimensions (cm):
21,1 / Ø 6,5 front / Ø 3,0 back

DURACELL®

VOYAGER

Die ideale Taschenlampe für unterwegs. Handliche Form, kleines Gewicht und gummierte Oberfläche

CLASSIC EXTENDED: Die Outdoor-Taschenlampe mit extra Lichtrillen, um sie im Dunkeln leichter wiederzufinden



CLASSIC EXTENDED



CLX-1



2x AA
Batterien incl.



- 3x Super Clear LED
- Gummiertes Gehäuse
- Handliche Form
- 2x AA Batterien enthalten
- Gewicht: 115g
- Leuchtdauer: ca. 14h
- Abmessungen (cm): 15,8 / Ø 4,4 vorne / Ø 2,7 hinten

- 3x Super Clear LED
- rubberized body
- handy design
- 2x AA batteries included
- weight: 115g
- endurance: approx. 14h
- dimensions (cm): 15,8 / Ø 4,4 front / Ø 2,7 rear

CLX-10



2x D
Batterien incl.



- 5x Super Clear LED
- Gummiertes Gehäuse
- Handliche Form
- 2x D-Batterien benötigt
- Gewicht: 290g
- Leuchtdauer: ca. 68h
- Abmessungen (cm): 21,1 / Ø 6,9 vorne / Ø 4,1 hinten

- 5x Super Clear LED
- rubberized body
- handy design
- 2x D batteries not included
- weight: 290g
- endurance: aprox. 68 h
- dimensions (cm): 21,1 / Ø 6,9 front / Ø 4,1 rear



Die ideale Taschenlampe für unterwegs. Handliche Form, kleines Gewicht und gummierte Oberfläche

DUO-C: Aluminium Taschenlampen in kompaktem, klassischem Design. Das perfekte Team für unterwegs.

DURACELL®

VOYAGER

PROMO-PACK

Duo-C



2x AA
Batterien incl.



- 1 LED
- Aluminium-Gehäuse
- Schlankes Design
- mit praktischer Tragschleufe
- 2x AA Batterien enthalten
- Abmessungen (cm):
17,4 / Ø 2,4 vorne / Ø 1,8 hinten

- 1 LED
- Aluminum body
- slim design
- with practical wrist strap
- 2x AA batteries included
- dimensions (cm):
17,4 / Ø 2,4 front / Ø 1,8 rear



3x AAA
Batterien incl.



- 9 LED
- Aluminium-Gehäuse
- Kompakt und robust
- mit praktischer Tragschleufe
- 3x AAA Batterien enthalten
- Abmessungen (cm):
8,6 / Ø 3,0 vorne / Ø 2,5 hinten

- 9 LED
- Aluminum body
- compact and sturdy
- with practical wrist strap
- 3x AAA batteries included
- dimensions (cm):
8,6 / Ø 3,0 front / Ø 2,5 rear

DURACELL®

EXPLORER

LANTERN

Der unverzichtbare Begleiter um die Welt zu erkunden - für freie Hände und gute Sicht

Lantern: Beim Camping, Wandern, oder anderen Aktivitäten im Freien hat die Lantern-Serie die perfekten Lichtquellen parat.



LNT-10



3x AAA
Batterien incl.

LNT-100



3x D
Batterien excl.

- 8x Super Clear LED
- Spritzwassergeschütztes Gehäuse
- 3x AAA Batterien enthalten
- Gewicht: 122g
- Abmessungen (cm):
15,0 / 7,0 / 5,9

- 8x Super clear LED
- splashproof body
- 3x AAA batteries included
- dimensions (cm):
15,0 / 7,0 / 5,9

- 16x Super Clear LED
- Spritzwassergeschütztes Gehäuse
- 3x D-Batterien benötigt
- Gewicht: 379g
- dimmbar
- Abmessungen (cm):
23,4 / 11,4 / 11,2

- 16x Super clear LED
- splashproof body
- 3x D batteries not included
- dimmable
- dimensions (cm):
23,4 8/ 11,4 / 11,2

EXPLORER Floating Lantern

Beim Camping, Wandern oder anderen Aktivitäten im Freien hat die Lantern-Serie die perfekten Lichtquellen parat

EXPLORER Headlamp Serie

Wenn Sie freie Hände gepaart mit guter Sicht brauchen, ist eine Lampe aus der Headlamp-Serie Ihr verlässlicher Begleiter

DURACELL®

EXPLORER

HEADLAMP

FLOATING LANTERN

FLN-1



4x D

Batterien excl.

- 19x Super Clear LED
- 4x D Batterien benötigt
- Lieferbar in blau und gelb
- Gewicht: 433g
- Abmessungen (cm): 18,2 / 14,0 / 12,0

- 19x Super Clear LED
- 4x D batteries not included
- available in blue or yellow
- weight: 433g
- dimensions (cm): 18,2 / 14,0 / 12,0

HDL-1



3x AAA

Batterien incl.

- 19x Super Clear LED
- 4 Lichtmodi: 1 LED / 7 LED / 19 LED oder Blinkmodus
- 3x AAA-Batterien inklusive
- 2,7 - 6,5 Gebrauchsspannung
- Gewicht: 115g
- Abmessungen (cm): 7,0 / 6,1 / 5,5

- 19x Super Clear LED
- 4 lightmodi: 1 LED / 7 LED, 19 LED or blinking mode
- 3x AAA batteries included
- weight: 115g
- dimensions (cm): 7,0 / 6,1 / 5,5



Typ ANSI	Beschreibung	IEC	Volt	Maße Batterien HxBxT (mm)	Chem. System	Haltbarkeit (Jahre)	Maße Konsumenteneinheit HxBxT (mm)	Gewicht Konsumenteneinheit (g)	Batterien/Pack	EAN
AA	MN1500 - AA K8	LR06	1,5	50 x 14 x 14	Alkaline	7	119 x 174 x 15	214	8	5000394018136
AA	MN1500 - AA K4	LR06	1,5	50 x 14 x 14	Alkaline	7	119 x 84 x 15	103	4	5000394017641
AAA	MN2400 - AAA K4	LR03	1,5	44 x 10 x 10	Alkaline	7	119 x 84 x 11	55	4	5000394018457
C	MN1400 - C K2	LR14	1,5	49 x 25 x 25	Alkaline	7	119 x 84 x 26	154	2	5000394019089
D	MN1300 - D K2	LR20	1,5	60 x 33 x 33	Alkaline	7	119 x 90 x 34	306	2	5000394019171
9V	MN1604 - 9V K1	6LR61	9	48 x 17 x 26	Alkaline	5	119 x 84 x 18	56	1	5000394019256



Typ ANSI	Beschreibung	IEC	Volt	Maße Batterien HxBxT (mm)	Chem. System	Haltbarkeit (Jahre)	Maße Konsumenteneinheit HxBxT (mm)	Gewicht Konsumenteneinheit (g)	Batterien/Pack	EAN
AA	MX1500 - AA K4	LR06	1,5	50 x 14 x 14	Alkaline	7	119 x 84 x 15	103	4	5000394002562
AAA	MX2400 - AAA K4	LR03	1,5	44 x 10 x 10	Alkaline	7	119 x 84 x 11	55	4	5000394002692
C	MX1400 - C K2	LR14	1,5	49 x 25 x 25	Alkaline	7	119 x 84 x 26	154	2	5000394002852
D	MX1300 - D K2	LR20	1,5	60 x 33 x 33	Alkaline	7	119 x 90 x 34	306	2	5000394002906
9V	MX1604 - 9V K1	6LR61	9	48 x 17 x 26	Alkaline	5	119 x 84 x 18	56	1	5000394002951

KNOPFZELLEN / SECURITY



Typ ANSI	IEC	Beschreibung	Volt	Kapazität (mAh)	Maße Batterien HxBxT (mm)	Chem. System	Haltbarkeit (Jahre)	Maße Konsumenteneinheit HxBxT (mm)	Gewicht Konsumenteneinheit (g)	Batterien/Pack	EAN
1616	DL1616	DL1616	3	55	2 x 16 x 16	Lithium	10	119 x 84 x 4	5	1	5000394030336
1620	DL1620	DL1620	3	75	2 x 16 x 16	Lithium	10	119 x 84 x 4	5	1	5000394030367
2016	DL2014	DL2016	3	90	2 x 20 x 20	Lithium	10	119 x 84 x 6	6	1	5000394033948
2025	DL2025	DL2025	3	165	2 x 20 x 20	Lithium	10	119 x 84 x 6	7	1	5000394033979
2032	DL2032	DL2032	3	220	3 x 20 x 20	Lithium	10	119 x 84 x 6	7	1	5000394033917
N BG2	LR-01	N BG2	1,5	825	30 x 11 x 11	Alkaline	5	121 x 86 x 12	28	2	5000394203983
MN21 BG2	3LR50	MN21 BG2	12	33	28 x 10 x 10	Alkaline	5	121 x 26 x 11	26	2	5000394203969



Typ ANSI	Beschreibung	IEC	Volt	Maße Batterien HxBxT (mm)	Chem. System	Batterien/ Pack	EAN
AA	Varta High Energy-AA	LR06	1,5	50 x 14 x 14	Alkaline	4	4008496559435
AAA	Varta High Energy-AAA	LR03	1,5	44 x 10 x 10	Alkaline	4	4008496559749
C	Varta High Energy-C	LR04	1,5	49 x 25 x 25	Alkaline	2	4008496559312
D	Varta High Energy-D	LR14	1,5	60 x 33 x 33	Alkaline	2	4008496559237
9V	Varta High Energy-9V	LR20	9	48 x 17 x 26	Alkaline	1	4008496559862
AA	Varta Max Tech-AA	LR06	1,5	50 x 14 x 14	Alkaline	4	4008496105946
AAA	Varta Max-Tech-AAA	LR03	1,5	44 x 10 x 10	Alkaline	4	4008496104734



Typ ANSI	Beschreibung	Volt	Kapazität (mAh)	Maße Batterien HxBxT (mm)	Chem. System	Batterien/ Pack	EAN
2016	ML2016	3	90	2 x 20 x 20	Lithium	1	4902580103019
2025	ML2025	3	165	2 x 20 x 20	Lithium	1	4902580103033
2032	ML2032	3	220	3 x 20 x 20	Lithium	1	4902580103040
2016	ML2016	3	90	2 x 20 x 20	Lithium	5	4902580131272
2025	ML2025	3	165	2 x 20 x 20	Lithium	5	4902580131265
2032	ML2032	3	220	3 x 20 x 20	Lithium	5	4902580131258

RADZIERBLENDEN WHEEL-COVERS



In unserem umfangreichen Radzierblendensortiment bieten wir Ihnen zwei verschiedene Qualitäten in den Größen 13“ bis 17“ (je nach Design)

ABS

Diese Radzierblenden sind aus schlagfestem ABS-Kunststoff gefertigt und, je nach Design, mit verchromten Elementen versehen. Diese Radzierblenden sind, je nach Modell, 1-fach oder 2-fach lackiert.

Nylon

Diese Radzierblenden in Erstaussatter-Qualität werden aus 100% hochwertigem Nylon gefertigt. Dadurch sind sie sehr strapazierfähig, schlagresistent, flexibel und witterungsbeständig. Auch diese Radzierblenden sind, je nach Design, mit verchromten Radmuttern bzw. Zierringen versehen und verleihen Ihrem Fahrzeug eine edle Optik. Alle Nylon-Radzierblenden sind 2-fach lackiert.

Alle PETEX-Radzierblenden zeichnen sich durch folgende Merkmale aus:

- für die meisten Stahlfelgen passend
- mit Kunststoffkrallen, dadurch kein zerkratzen der Felge
- Ventilaussparung
- Sicherheitsmetallspanning, dadurch immer gleichmäßiger Druck auf den Haltekrallen
- Einfache Reinigung
- Einfache Montage ohne Werkzeug



In our wide range of wheel-covers we are offering two different qualities, depending on the design, in sizes from 13“ to 17”.

ABS

These wheel-covers are made of strong ABS-plastic material and come with chrome-plated wheel-nuts, respectively ornamental rings. Depending on the model, our ABS wheel-covers are single- or double-painted and come in a handy carton-box, containing a full set of four pieces.

Nylon

These wheel-covers in OEM-premium-quality are made of 100% high-quality nylon material. Thus, they are very sturdy, impact resistant, flexible and weather proof. Also these wheel-covers come, depending on the design, with chrome-plated wheel-nuts, respectively ornamental rings, which gives your car a classy look. All nylon wheel-covers are double-painted and come in a handy carton-box, containing a full set of four pieces.

All PETEX wheel-covers are characterized by the following features:

- suitable for most steel-rims
- no scratches on the rim due to plastic-claws
- valve notch
- metal safety-ring, which ensures an even tension of the plastic claws
- easy to clean
- easy installation without any tools



Alabama ABS



- 1-fach lackiert
- Verpackungseinheit: 1 Satz = 4 Stück



- single painted
- packing unit: 1 Set = 4 pieces

Art.-Nr.	Zoll		VPE Umkarton
RB502113	13"	-	5 Satz
RB502114	14"	-	5 Satz
RB502115	15"	-	5 Satz
RB502116	16"	-	5 Satz



Avalon pro ABS



- 2-fach lackiert mit Chromring
- Verpackungseinheit: 1 Satz = 4 Stück



- double painted with chrome-plated ring
- packing unit: 1 Set = 4 pieces

Art.-Nr.	Zoll		VPE Umkarton
RB539314	14"	-	5 Satz
RB539315	15"	+	5 Satz
RB539316	16"	+	5 Satz



Daytona pro ABS



- 2-fach lackiert mit Chromring
- Verpackungseinheit: 1 Satz = 4 Stück





- double painted with chrome-plated ring
- packing unit: 1 Set = 4 pieces

Art.-Nr.	Zoll		VPE Umkarton
RB546214	14"	+	5 Satz
RB546215	15"	+	5 Satz
RB546216	16"	+	5 Satz

Daytona pro Black**ABS**

-  - 2-fach lackiert
- Verpackungseinheit: 1 Satz = 4 Stück

-  - double painted
- packing unit: 1 Set = 4 pieces

Art.-Nr.	Zoll		VPE Umkarton
RB546614	14"	+	5 Satz
RB546615	15"	+	5 Satz
RB546616	16"	+	5 Satz

**Evo Race Pro****ABS**

-  - 1-fach lackiert
- Verpackungseinheit: 1 Satz = 4 Stück

-  - single painted
- packing unit: 1 Set = 4 pieces

Art.-Nr.	Zoll		VPE Umkarton
RB542214	14"	+	5 Satz
RB542215	15"	+	5 Satz
RB542216	16"	+	5 Satz

**Giga****ABS**

-  - 1-fach lackiert
- Verpackungseinheit: 1 Satz = 4 Stück

-  - single painted
- packing unit: 1 Set = 4 pieces

Art.-Nr.	Zoll		VPE Umkarton
RB529113	13"	-	5 Satz
RB529114	14"	-	5 Satz
RB529115	15"	+	5 Satz
RB529116	16"	+	5 Satz





Le Mans pro			ABS
	- 2-fach lackiert mit Chromring - Verpackungseinheit: 1 Satz = 4 Stück		
	- double painted with chrome-plated ring - packing unit: 1 Set = 4 pieces		
Art.-Nr.	Zoll		VPE Umkarton
RB543514	14"	+	5 Satz
RB543515	15"	+	5 Satz
RB543516	16"	+	5 Satz



Magnum Pro			ABS
	- 2-fach lackiert mit Chromring - Verpackungseinheit: 1 Satz = 4 Stück		
	- double painted with chrome-plated ring - packing unit: 1 Set = 4 pieces		
Art.-Nr.	Zoll		VPE Umkarton
RB545214	14"	+	5 Satz
RB545215	15"	+	5 Satz
RB545216	16"	+	5 Satz



Magnum Pro Black			ABS
	- 1-fach lackiert mit Chromring - Verpackungseinheit: 1 Satz = 4 Stück		
	- single painted with chrome-plated ring - packing unit: 1 Set = 4 pieces		
Art.-Nr.	Zoll		VPE Umkarton
RB545614	14"	+	5 Satz
RB545615	15"	+	5 Satz
RB545616	16"	+	5 Satz

Mecador**ABS**

- 2-fach lackiert mit verchromten Radmuttern
- Verpackungseinheit: 1 Satz = 4 Stück



- double painted with chrome-plated wheel-nuts
- packing unit: 1 Set = 4 pieces

Art.-Nr.	Zoll		VPE Umkarton
RB510313	13"	-	5 Satz
RB510314	14"	-	5 Satz
RB510315	15"	-	5 Satz
RB510316	16"	-	5 Satz
RB510317	17"	-	5 Satz

**Nardo****ABS**

- 2-fach lackiert
- Verpackungseinheit: 1 Satz = 4 Stück



- double painted
- packing unit: 1 Set = 4 pieces

Art.-Nr.	Zoll		VPE Umkarton
RB547514	14"	+	5 Satz
RB547515	15"	+	5 Satz
RB547516	16"	+	5 Satz

**Opus****ABS**

- 1-fach lackiert
- Verpackungseinheit: 1 Satz = 4 Stück



- single painted
- packing unit: 1 Set = 4 pieces

Art.-Nr.	Zoll		VPE Umkarton
RB530113	13"	-	5 Satz
RB530114	14"	-	5 Satz
RB530115	15"	+	5 Satz
RB530116	16"	+	5 Satz





Racing

ABS



- 1-fach lackiert
- Verpackungseinheit: 1 Satz = 4 Stück



- single painted
- packing unit: 1 Set = 4 pieces

Art.-Nr.	Zoll		VPE Umkarton
RB522213	13"	-	5 Satz
RB522214	14"	-	5 Satz
RB522215	15"	+	5 Satz
RB522216	16"	+	5 Satz



Radical pro

ABS



- 2-fach lackiert mit Chromring
- Verpackungseinheit: 1 Satz = 4 Stück



- double painted with chrome-plated ring
- packing unit: 1 Set = 4 pieces

Art.-Nr.	Zoll		VPE Umkarton
RB535114	14"	+	5 Satz
RB535115	15"	+	5 Satz
RB535116	16"	+	5 Satz



Radical pro white

ABS





- 2-fach lackiert mit Chromring
- Verpackungseinheit: 1 Satz = 4 Stück



- double painted with chrome-plated ring
- packing unit: 1 Set = 4 pieces

Art.-Nr.	Zoll		VPE Umkarton
RB535714	14"	+	5 Satz
RB535715	15"	+	5 Satz
RB535716	16"	+	5 Satz



RS-T **ABS**

-  - 2-fach lackiert
- Verpackungseinheit: 1 Satz = 4 Stück
-  - double painted
- packing unit: 1 Set = 4 pieces

Art.-Nr.	Zoll		VPE Umkarton
RB534114	14"	+	5 Satz
RB534115	15"	+	5 Satz
RB534116	16"	+	5 Satz





Silverstone pro black **ABS**

-  - 1-fach lackiert mit Chromring
- Verpackungseinheit: 1 Satz = 4 Stück
-  - single painted with chrome-plated ring
- packing unit: 1 Set = 4 pieces

Art.-Nr.	Zoll		VPE Umkarton
RB531614	14"	-	5 Satz
RB531615	15"	+	5 Satz
RB531616	16"	+	5 Satz
RB531617	17"	+	5 Satz



Silverstone pro dark **ABS**

-  - 2-fach lackiert mit Chromring
- Verpackungseinheit: 1 Satz = 4 Stück
-  - double painted with chrome-plated ring
- packing unit: 1 Set = 4 pieces

Art.-Nr.	Zoll		VPE Umkarton
RB531313	13"	-	5 Satz
RB531314	14"	-	5 Satz
RB531315	15"	+	5 Satz
RB531316	16"	+	5 Satz
RB531317	17"	+	5 Satz





Speed			ABS
	- 2-fach lackiert - Verpackungseinheit: 1 Satz = 4 Stück		
	- double painted - packing unit: 1 Set = 4 pieces		
Art.-Nr.	Zoll		VPE Umkarton
RB514213	13"	-	5 Satz
RB514214	14"	-	5 Satz
RB514215	15"	-	5 Satz
RB514216	16"	-	5 Satz

Neu - New



Sporty			ABS
	- 1-fach lackiert - Verpackungseinheit: 1 Satz = 4 Stück		
	- single painted - packing unit: 1 Set = 4 pieces		
Art.-Nr.	Zoll		VPE Umkarton
RB533013	13"	-	5 Satz
RB533014	14"	+	5 Satz
RB533015	15"	+	5 Satz
RB533016	16"	+	5 Satz



Voltec Pro black/red			ABS
	- 2-fach lackiert - Verpackungseinheit: 1 Satz = 4 Stück		
	- double painted - packing unit: 1 Set = 4 pieces		
Art.-Nr.	Zoll		VPE Umkarton
RB548514	14"	+	5 Satz
RB548515	15"	+	5 Satz
RB548516	16"	+	5 Satz



Voltec Pro black/white**ABS**

- 2-fach lackiert
- Verpackungseinheit: 1 Satz = 4 Stück



- double painted
- packing unit: 1 Set = 4 pieces

Art.-Nr.	Zoll		VPE Umkarton
RB548714	14"	+	5 Satz
RB548715	15"	+	5 Satz
RB549716	16"	+	5 Satz

**VR****ABS**

- 2-fach lackiert
- Verpackungseinheit: 1 Satz = 4 Stück



- double painted
- packing unit: 1 Set = 4 pieces

Art.-Nr.	Zoll		VPE Umkarton
RB540214	14"	+	5 Satz
RB540215	15"	+	5 Satz
RB540216	16"	+	5 Satz

**VR black****ABS**

- 1-fach lackiert
- Verpackungseinheit: 1 Satz = 4 Stück





- single painted
- packing unit: 1 Set = 4 pieces

Art.-Nr.	Zoll		VPE Umkarton
RB540614	14"	+	5 Satz
RB540615	15"	+	5 Satz
RB540616	16"	+	5 Satz







Volante			ABS
	- 2-fach lackiert - Verpackungseinheit: 1 Satz = 4 Stück		
	- double painted - packing unit: 1 Set = 4 pieces		
Art.-Nr.	Zoll		VPE Umkarton
RB549514	14"	+	5 Satz
RB549515	15"	+	5 Satz
RB549516	16"	+	5 Satz



Mega			Nylon
	- 2-fach lackiert - Verpackungseinheit: 1 Satz = 4 Stück		
	- double painted - packing unit: 1 Set = 4 pieces		
Art.-Nr.	Zoll		VPE Umkarton
RB538414	14"	+	5 Satz
RB538415	15"	+	5 Satz
RB538416	16"	+	5 Satz





Mythos			Nylon
	- 2-fach lackiert - Verpackungseinheit: 1 Satz = 4 Stück		
	- double painted - packing unit: 1 Set = 4 pieces		
Art.-Nr.	Zoll		VPE Umkarton
RB528413	13"	-	5 Satz
RB528414	14"	-	5 Satz
RB528415	15"	+	5 Satz
RB528416	16"	+	5 Satz

Platinum			Nylon
	- 2-fach lackiert - Verpackungseinheit: 1 Satz = 4 Stück		
	- double painted - packing unit: 1 Set = 4 pieces		
Art.-Nr.	Zoll		VPE Umkarton
RB524413	13"	-	5 Satz
RB524414	14"	+	5 Satz
RB524415	15"	+	5 Satz
RB524416	16"	+	5 Satz



Racing pro			Nylon
	- 2-fach lackiert - Verpackungseinheit: 1 Satz = 4 Stück		
	- double painted - packing unit: 1 Set = 4 pieces		
Art.-Nr.	Zoll		VPE Umkarton
RB532413	13"	-	5 Satz
RB532414	14"	-	5 Satz
RB532415	15"	+	5 Satz
RB532416	16"	+	5 Satz



Spyder pro			Nylon
	- 2-fach lackiert mit Chromring - Verpackungseinheit: 1 Satz = 4 Stück		
	- double painted with chrome-plated ring - packing unit: 1 Set = 4 pieces		
Art.-Nr.	Zoll		VPE Umkarton
RB536414	14"	+	5 Satz
RB536415	15"	+	5 Satz
RB536416	16"	+	5 Satz





Spyder pro dark Nylon

- 2-fach lackiert mit Chromring
- Verpackungseinheit: 1 Satz = 4 Stück
- double painted with chrome-plated ring
- packing unit: 1 Set = 4 pieces

Art.-Nr.	Zoll		VPE Umkarton
RB536914	14"	+	5 Satz
RB536915	15"	+	5 Satz
RB536916	16"	+	5 Satz



Spyder pro white Nylon

- 2-fach lackiert mit Chromring
- Verpackungseinheit: 1 Satz = 4 Stück
- double painted with chrome-plated ring
- packing unit: 1 Set = 4 pieces

Art.-Nr.	Zoll		VPE Umkarton
RB536814	14"	+	5 Satz
RB536815	15"	+	5 Satz
RB536816	16"	+	5 Satz



Venture pro Nylon

- 2-fach lackiert mit Chromring
- Verpackungseinheit: 1 Satz = 4 Stück
- double painted with chrome-plated ring
- packing unit: 1 Set = 4 pieces

Art.-Nr.	Zoll		VPE Umkarton
RB544414	14"	+	5 Satz
RB544415	15"	+	5 Satz
RB544416	16"	+	5 Satz

Eiskratzer & Schneebesen

Ice scraper & snow brushes



Hochwertige Qualität
High quality
made in Canada



Eiskratzer mit Schneebesen und Gummilippe

- Ausziehbare Teleskopstange (95 cm - 150 cm)*
- Mit 2 rutschfesten Softgriffen
- Eiskratzer aus äußerst stabilem, hochwertigem Polycarbonat
- Besen um 90° schwenkbar
- Sortiert im Karton
- Farben: rot/blau



Ice scraper with snow brush and rubber squeegee

- extends from 95 cm to 150 cm *
- with two ergonomic softgrips
- blade made of sturdy polycarbonate
- tiltable head (90°)
- packed in standard carton
- colours assorted: blue/red)



Art.-Nr.	VPE / packing unit
46040000	6 Stück / pieces



Art.-Nr.	VPE / packing unit
45010000	24 Stück / pieces

Eiskratzer

- Länge 25 cm
- Aus äußerst stabilem, hochwertigem Polystyren
- sortiert im praktischen Display
- Farben: rot/blau

Ice scraper

- length: 25 cm
- made of sturdy polystyrene
- packed in a practical shelf display
- colours assorted: blue/red



Art.-Nr.	VPE / packing unit
45020000	24 Stück / pieces

Eiskratzer mit Softgriff

- Länge: 25 cm
- Aus äußerst stabilem, hochwertigem Polycarbonat
- Mit rutschfestem Softgriff
- sortiert im praktischen Display
- Farben: rot/blau

Ice scraper with foam grip

- length: 25 cm
- made of sturdy polycarbonate
- ergonomic foam grip
- packed in a practical shelf display
- colours assorted: blue/red



Art.-Nr.	VPE / packing unit
45030000	18 Stück / pieces

Schneebesen mit Eiskratzer

- Länge: 40cm
- Eiskratzer aus äußerst stabilem, hochwertigem Polycystyren
- sortiert im praktischen Display
- Farben: blau/gelb

Snow brush with ice scraper

- length: 40 cm
- ice scraper made of sturdy polystyrene
- packed in a practical shelf-display
- colours assorted: blue/yellow



Eiskratzer mit Schneebeesen

- Länge: 66 cm
- Eiskratzer aus äußerst stabilem, hochwertigem Polycarbonat
- Mit rutschfestem Softgriff
- Sortiert im Display
- Farben: rot/blau



Ice scraper with snow brush

- length: 66 cm
- blade made of sturdy polycarbonate
- ergonomic foam grip
- packed in a practical shelf-display
- colours assorted: blue/red



Art.-Nr.	VPE / packing unit
45040000	24 Stück / pieces



Eiskratzer mit Schneebeesen und Gummilippe

- Ausziehbare Teleskopstange (58 cm - 91 cm)*
- Mit rutschfestem Softgriff
- Eiskratzer aus äußerst stabilem, hochwertigem Polycarbonat
- Lieferung im praktischen Display
- Farbe: rot



Ice scraper with snow brush and rubber squeegee

- extends from 58 to 91 cm*
- ergonomic foam grip
- blade made of sturdy polycarbonate
- packed in a practical shelf-display
- colour: red



Art.-Nr.	VPE / packing unit
46010000	16 Stück / pieces



Eiskratzer mit Schneebeesen und Gummilippe

- Ausziehbare Teleskopstange (66 cm - 89 cm)*
- Mit rutschfestem Softgriff
- Eiskratzer aus äußerst stabilem, hochwertigem Polycarbonat
- Besen um 90° schwenkbar
- Sortiert im Display
- Farben: rot/blau



Ice scraper with snow brush and rubber squeegee

- extends from 66 cm to 89 cm *
- ergonomic foam grip
- blade made of sturdy polycarbonate
- tiltable head (90°)
- packed in standard carton,
- colours assorted: blue/red



Art.-Nr.	VPE / packing unit
46020000	15 Stück / pieces



Art.-Nr.	VPE / packing unit
46030000	14 Stück / pieces



Eiskratzer mit Schneebesen und Gummilippe

- Ausziehbare Teleskopstange (86 cm - 132 cm)*
- Mit rutschfestem Softgriff
- Eiskratzer aus äußerst stabilem, hochwertigem Polycarbonat
- Besen um 90° schwenkbar
- Sortiert im Display
- Farben: rot/blau



Ice scraper with snow brush and rubber squeegee

- extends from 86 cm to 132 cm *
- ergonomic foam grip
- blade made of sturdy polycarbonate
- tiltable head (90°)
- packed in standard carton
- colours assorted: blue/red



Art.-Nr.	VPE / packing unit
45050000	6 Stück / pieces



Eiskratzer mit Schneebesen

- Länge: 89 cm
- Robustes Aluminium-Rohr*
- Mit rutschfestem Softgriff
- Eiskratzer aus äußerst stabilem, hochwertigem Polycarbonat
- Farblich sortiert im Karton (rot/blau)



Ice scraper with snow brush

- length: 89 cm
- strong anodised aluminum tube
- ergonomic softgrip
- blade made of sturdy polycarbonate
- packed in standard carton
- colours assorted: blue/red



Art.-Nr.	VPE / packing unit
45060000	24 Stück / pieces



Eiskratzer mit Schneebesen

- Länge: 61 cm
- Eiskratzer aus äußerst stabilem, hochwertigem Polycarbonat
- Schneebesen aus Santopren
- Sortiert im Display
- Farben: rot/blau



Ice scraper with snow brush

- length: 61 cm
- blade made of sturdy polycarbonate
- snow brush made of santoprene
- packed in standard carton
- colours assorted: blue/red



Schneeschaufel

- Schaufel mit Teleskop-Stiel, ausziehbar von 77 cm bis 102 cm
- Schaufel bestehend aus äußerst stabilem, hochwertigen Polyethylen
- Stiel aus robustem, eloxiertem Aluminium
- Mit rutschfestem Softgriff
- Farblich sortiert im Standdisplay (blau, rot, gelb)



Snow shovel

- telescopic shovel, extends from 77 cm to 102 cm
- shovel made of hard-wearing, high quality polyethylene
- shaft made of sturdy, anodised aluminium
- ergonomic foam-grip
- colours assorted in POS-display (blue, red, yellow)



Art.-Nr.	VPE / packing unit
47600000	12 Stück / pieces



Verkaufsständer

- 2 Ebenen mit 8 Armen zur Warenpräsentation
- Mit 4 Rollen
- drehbar
- Grundfläche ca. 55 x 55 cm



Wheeled spinner-rack

- two tier display with 8 arms to present your ice-scrapers
- with four wheels
- revolvable
- base area: approx. 55 x 55 cm



Art.-Nr.	VPE / packing unit
47010000	1 Stück / piece



Art.-Nr.	Duft	Einheiten VPE	VPE
53110200	Meeresfrische	6	1
53110300	Vanille	6	1
53110100	Frühlingserwachen	6	1
53110000	Antitabak	6	1



Art.-Nr.	Farbe	VPE
432100	blau	6



Art.-Nr.	Farbe	VPE
432110	blau	6



Febreze Car

„Febreze Car“ ist der einzige Lufterfrischer für das Auto, der die einzigartige Febreze Geruchseliminierungs-Technologie enthält, die tatsächlich schlechte Gerüche entfernt und nichts als einen leichten frischen Duft hinterlässt.

- Entfernt Gerüche und spendet Frische für bis zu 30 Tage (abhängig von Temperatur und eingestellter Stärke der Lüftung)
- Im praktischen 6er Pack
- 4 verschiedene Düfte lieferbar



Febreze car

“Febreze Car” is the only air-freshener for cars containing the unique Febreze odour-elimination-technology, which removes bad smell for real and does not leave anything but a slight, fresh smell.

- Removes bad smell and dispends freshness for up to 30 days (depending on temperature and tuned degree of ventilation)
- In a convenient 6 piece pack
- 4 different scents available



Großes Mikrofaser Trockentuch Art. 432100

- ca. 92 x 62 cm
- hi-tech Mikrofasergerewebe sammelt und zieht Wasser von der Fahrzeug-Oberfläche
- für ein streifenfreies und flusenfreies Ergebnis
- gesteppte Konstruktion erhöht die Saugfähigkeit welche mit Gebrauch zunimmt



Massive Microfiber Drying Towel Art. 432100

- approx. 92 x 62 cm
- Advanced microfiber weave gently liftpulls water away from vehicle surface
- Results in a streak-free, lint-free finish
- Quilted construction increases absorbency that improves with use



Ultrasaugfähiges Trockentuch Art. 432110

- ca. 65 x 43 cm
- streifenfreies Trocknen
- übertrifft herkömmliche Handtücher und Leder
- perfekt für Auto, Boot oder zu Hause
- hält Schimmel und Moder stand



Ultra Absorbent Drying Towel Art. 432110

- approx. 65 x 43 cm
- Streak-Free Drying
- Outperforms traditional towels or chamois
- Perfect for auto, boat or home
- Engineered to resist mold & mildew



Wasch - und Reinigungsschwamm Art. 432200

- Mikrofaser Reinigungsgewebe entfernt hartnäckigen Schmutz
- dicke, saugfähige Ausführung für hervorragende Ergebnisse
- schonend für Deck- und Klarlack-Lackierungen
- praktische Schlaufe zum aufhängen, trocknen und aufbewahren
- Farbe: blau



Wash & Scrub Sponge Art. 432200

- Microfiber scrubbing mesh removes stubborn dirt & grime
- Thick, absorbent construction delivers superior results
- Safe on premium paint finishes & clearcoat
- Handy hang loop for convenient drying & storage
- colour: blue



Art.-Nr.	Abmessungen	VPE
432200	ca. 26,5 x 14 x 7,5 cm	6



Ultra Plüsch Staubwedel Art. 432210

- aus Mikrofaser
- entfernt mühelos Staub im Innenraum
- ca. 34 x 18 cm
- Farbe: blau



Ultra Plush Duster Art. 432210

- made of microfibre
- easily removes dust from the interior
- approx. 34 x 18 cm
- colour: blue



Art.-Nr.	Abmessungen	VPE
432210	ca. 34 x 18 cm	6



Reifenbürste Art. 432300

- stabile Borsten um hartnäckigen Schmutz an Reifen und in Radhäusern zu entfernen
- ca. 30 cm
- Farbe: schwarz



Tire Brush Art. 432300

- sturdy bristle to remove stubborn dirt from tyres and wheelhouses
- approx. 30 cm
- colour: black



Art.-Nr.	Abmessungen	VPE
432300	ca. 30 cm	4



Art.-Nr.	Abmessungen	VPE
432310	ca. 43 cm	4



Waschbürste Art. 432310

- extra weiche Borsten, kein verkratzen
- gummierter Griff für bessere Handhabung
- ca. 43 cm
- Farbe: weiß



Grill Brush Art. 432310

- Extra soft bristle, will not scratch
- rubberised grip for better use
- approx. 43 cm
- colour: white



Art.-Nr.	Abmessungen	VPE
432320	99 - 152 cm	5



Teleskop-Waschbürste Art. 432320

- robustes Aluminiumrohr
- regelbares Wassersparventil
- passend für Standard-Gartenschlauchanschlüsse
- Komfort-Schaumstoffgriffe
- schützende Stoßleiste
- Farbe: blau



telescopic Wash Brush Art. 432320

- Sturdy aluminum handle
- Adjustable water saver valve
- Connects to standard garden hose
- Comfort foam grips
- Protective bumper
- colour: blue



Art.-Nr.	Abmessungen	VPE
432330	109 - 165 cm	4



Teleskop-Waschbürste Art. 432330

- sehr stabile Arretierung / Komfort-Schaumstoffgriffe
- regelbares Wassersparventil
- passend für Standard-Gartenschlauchanschlüsse
- 25 cm großer Bürstenkopf für maximale Reinigung
- gerundete Form zur leichten Reinigung unregelmäßiger Oberflächen
- schützende Stoßleiste
- Farbe: weiß



Telescopic Wash Brush Art. 432330

- Heavy duty lock / Comfort foam grips
- Adjustable water saver valve
- Connects to standard garden hose
- Massive 25 cm brush head for maximum cleaning
- Contoured shape easily cleans irregular surfaces
- Protective bumper
- colour: white



Scheibenabzieher Kopf klein Art. 432400

- mit netzüberzogenem Schwamm zur mühelosen Entfernung von hartnäckigen Verschmutzungen
- stabile, verzinkte Metall-Profilleiste
- solide, breite Gummilippe
- Stiel und Kopf mit Schraubgewinde, d.h. beide Teile können bei Bedarf entsprechend einfach ausgetauscht und erneuert werden



Little squeegee head Art. 432400

- net-overcast sponge for effortless removal of persistent dirt
- solid, zinc plated steel-head
- stable, wide rubber-squeegee
- handle and head with screw thread, i.e. both pieces can be easily exchanged and replaced if need be

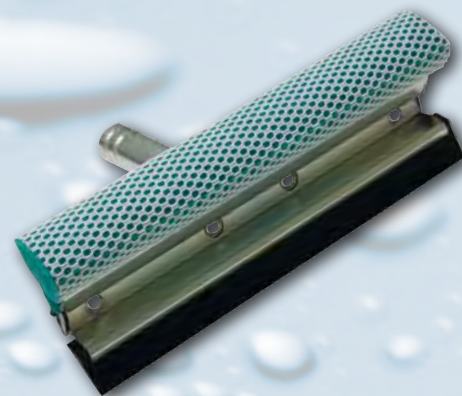

Art.-Nr.	Breite	VPE
432400	20,3 cm	12



Scheibenabzieher Kopf groß Art. 432410

- mit netzüberzogenem Schwamm zur mühelosen Entfernung von hartnäckigen Verschmutzungen
- stabile, verzinkte Metall-Profilleiste
- solide, breite Gummilippe
- Stiel und Kopf mit Schraubgewinde, d.h. beide Teile können bei Bedarf entsprechend einfach ausgetauscht und erneuert werden



Big squeegee head Art. 432410

- net-overcast sponge for effortless removal of persistent dirt
- solid, zinc plated steel-head
- stable, wide rubber-squeegee
- handle and head with screw thread, i.e. both pieces can be easily exchanged and replaced if need be

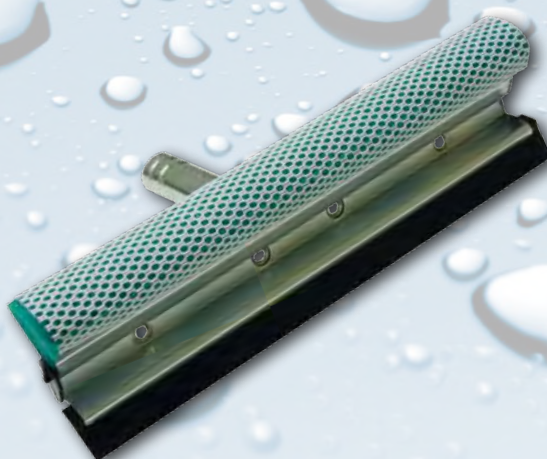

Art.-Nr.	Breite	VPE
432410	25,4 cm	12



Scheibenabzieher Stiele Art. 4324

- Robuste Ausführung
- mit Schraubgewinde, passend für kleinen und großen Scheibenabzieher-Kopf
- Einfacher Tausch des Kopfes möglich
- lieferbar in 2 verschiedenen Längen



squeegee handles Art. 4324

- solid design
- with screw thread, suitable for small and large squeegeeheads
- simple exchange of the head
- available in 2 different lengths



Art.-Nr.	Länge	VPE
432420	40 cm	24
432430	52,7 cm	24



Motorrad Nylon-Schutzgarage

Art. 4423

- 100% Nylon
- Schmutz, staub- und wasserabweisend
- Platzsparend zusammenlegbar mit praktischer Aufbewahrungstasche
- UV-beständig
- Gummizüge im Saum gewährleisten einen festen Sitz und schließen das Motorrad nach unten ab
- Universell passend,
- 2 Größen lieferbar



Bicycle Nylon protection cover

Art. 4423

- 100 % nylon
- dirt-, dust- and water-repellent
- space-savingly foldable – with handy storage-tote
- UV-resistant
- elastic bands in the hem ensure a firm fit
- universal fit
- two sizes available



Art.-Nr.	Größe	Abmessungen	VPE
44230101	M	ca. 203 x 89 x 119 cm	30
44230201	XL	ca. 246 x 104 x 127 cm	30





Hagelschutzgarage

Art. 4421

Schützt das Dach, die Motorhaube sowie den Bereich des Kofferraumes vor herabfallenden Ästen und Hagelschlag.

- Aus 5 mm dickem, festem Schaumstoff
- Außenseite beschichtet mit wasserundurchlässiger Folie
- Innenseite kaschiert mit weichem, lackschonendem „non-woven / Fließ“ Material
- Wetter- und UV-beständig
- Lackschonend & atmungsaktiv
- Wasserdicht
- Fester Sitz durch Gummizüge und Haltegurte
- 4 Größen lieferbar



Hail protection cover

Art. 4421

The cover protects the cars' roof, hood and trunk, against branches falling down from trees and against hailstones.

- made of 5 mm thick compressed foam
- outside coated with waterproof foil
- inside laminated with soft, protective non-woven material.
- weatherproof and UV light-fast
- breathable & soft - prevents varnished surfaces from being scratched
- waterproof
- firm fit due to elastic bands and straps
- 4 sizes available



Art.-Nr.	Größe	Abmessungen	VPE
44210103	M	432 x 165 x 119 cm	3
44210003	L	482 x 178 x 119 cm	3
44210203	XL	533 x 178 x 119 cm	3
44210303	XXL	571 x 203 x 119 cm	3





Nylon-Schutzgarage

Art. 4422

- 100% Nylon
- Schmutz, staub- und wasserabweisend
- Platzsparend zusammenlegbar mit praktischer Aufbewahrungstasche
- UV-beständig
- Gummizüge im Saum gewährleisten einen festen Sitz und schließen das Fahrzeug nach unten ab
- Passend für Fahrzeuge mit Stufen- und Fließheck
- Universell passend
- 4 Größen lieferbar



Nylon protection cover

Art. 4422

- 100 % nylon
- dirt-, dust- and water-repellent
- space-savingly foldable – with handy storage-tote
- UV-resistant
- elastic bands in the hem ensure a firm fit
- suitable for cars with notchback or hatchback
- universal fit
- 4 sizes available

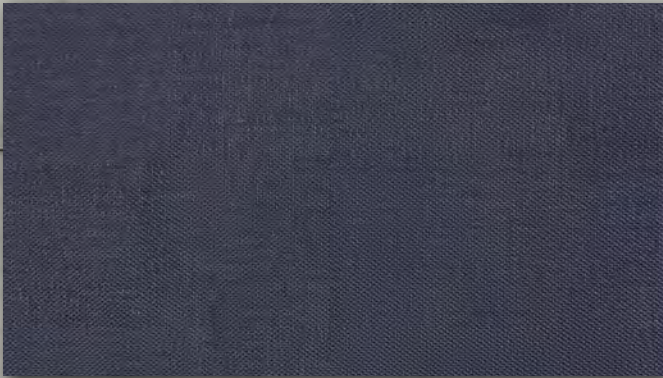

Art.-Nr.	Größe	Abmessungen	VPE
44220005	M	432 x 165 x 119 cm	10
44220105	L	482 x 178 x 119 cm	10
44220205	XL	533 x 178 x 119 cm	10
44220305	XXL	572 x 203 x 122 cm	10





PETEX Autoausstattungs-GmbH
Lauterbachstraße 44
D-84307 Eggenfelden

☎ +49 (0) 87 21 / 96 97 0
☎ +49 (0) 87 21 / 96 97 40
🌐 www.petex.net
✉ kontakt@petex.net



PETEX Zentrallager - Mitterhof



PETEX Deutschland



PETEX Autoausstattungs-Ges.mBH
Kirchstettener Straße 2
A-4064 Oftring

☎ +43 (0) 72 21 / 6 45 46 0
☎ +43 (0) 72 21 / 6 45 46 46
🌐 www.petex.net
✉ office@petex.at



PETEX Österreich



Automotive PETEX s.r.o.
Vrchlabská 246
CZ-54371 Hostinné

☎ +42 0 49 94 / 0 41 63
☎ +42 0 49 94 / 0 41 50
🌐 www.petex.net
✉ prodej@petex-auto.cz



PETEX Tschechische Republik