

















## MONTAGEANLEITUNG

-  MONTAGEANLEITUNG
-  ASSEMBLY INSTRUCTION
-  DE INSTRUCTIE VAN DE ASSEMBLAGE
-  ISTRUZIONE DELL'ASSEMBLEA
-  INSTRUCCIÓN DE ASAMBLEA
-  INSTRUCTION DE MONTAGE
-  NÁVOD K MONTÁŽI
-  MONTERINGSANVISNING

-  MONTAJ TALIMATI
-  ASENNUSOHJE
-  BRUGSANVISNING
-  BRUKSANVISNING
-  UPUTE ZA MONTAŽU
-  NAVODILA ZA MONTAŽO
-  SZERELÉSI ÚTMUTATÓ
-  INSTRUCTIUNI DE MONTAJ



Modell-Nr.

# 12080

ART.-NR. FRONT KORPUS

12081  Silber

12082  Silber

12084  Silber

12087  Silber

12086  

Friedrich Küpper GmbH  
Friedrich-Küpper-Weg  
54570 Berlingen  
Deutschland

Telefon +49 (0) 65 91 - 95 42 0  
Telefax +49 (0) 65 91 - 95 42 17  
E-Mail [info@friedrich-kuepper-gmbh.de](mailto:info@friedrich-kuepper-gmbh.de)  
Internet [www.friedrich-kuepper-gmbh.de](http://www.friedrich-kuepper-gmbh.de)

## EINZELTEILE / PIECES

**A**

**1x**

772 mm x 475 mm



**C**

**1x**

1057 mm x 473 mm



**B**

**1x**

772 mm x 475 mm



**D**

**1x**

1057 mm x 473 mm



**F**

**1x**

505 mm x 450 mm



**E**

**1x**

985 mm x 480 mm



**K**

**1x**

403 mm x 468 mm



**Y**

**1x**

1200 mm x 600 mm



**L**

**1x**

400 mm x 25 mm

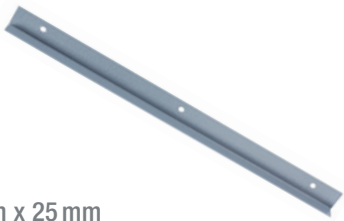

**J**

**3x**

450 mm x 120 mm



**X**

**3x**

450 mm x 20 mm



**H**

**3x**

450 mm x 445 mm



**I**

**3x**

470 mm x 130 mm



BEUTELINHALT / BAG CONTENT

 4x 5,5x19 mm	 6x KU 4x16 mm	 18x M5x10 mm	 18x ø5,3 mm	 18x M5	 24x M4 x10 mm
 24x M4	 1x M6x16 mm	 1x ø6,4 mm	 1x M6	 1x 6x12 mm	 1x
 1x	 1x	 4x	 4x	 4x M8	 3x

BENÖTIGTES WERKZEUG / NEEDED TOOLS

 ① PH 1x100 PH 2x100 Schlitz 6,5x150	 ② SW 7 SW 8 SW 10	 ③ 4 mm
 ④	 ⑤	 ⑥ 5 mm
 ⑦	 ⑧	

1.



2. WICHTIG / IMPORTANT

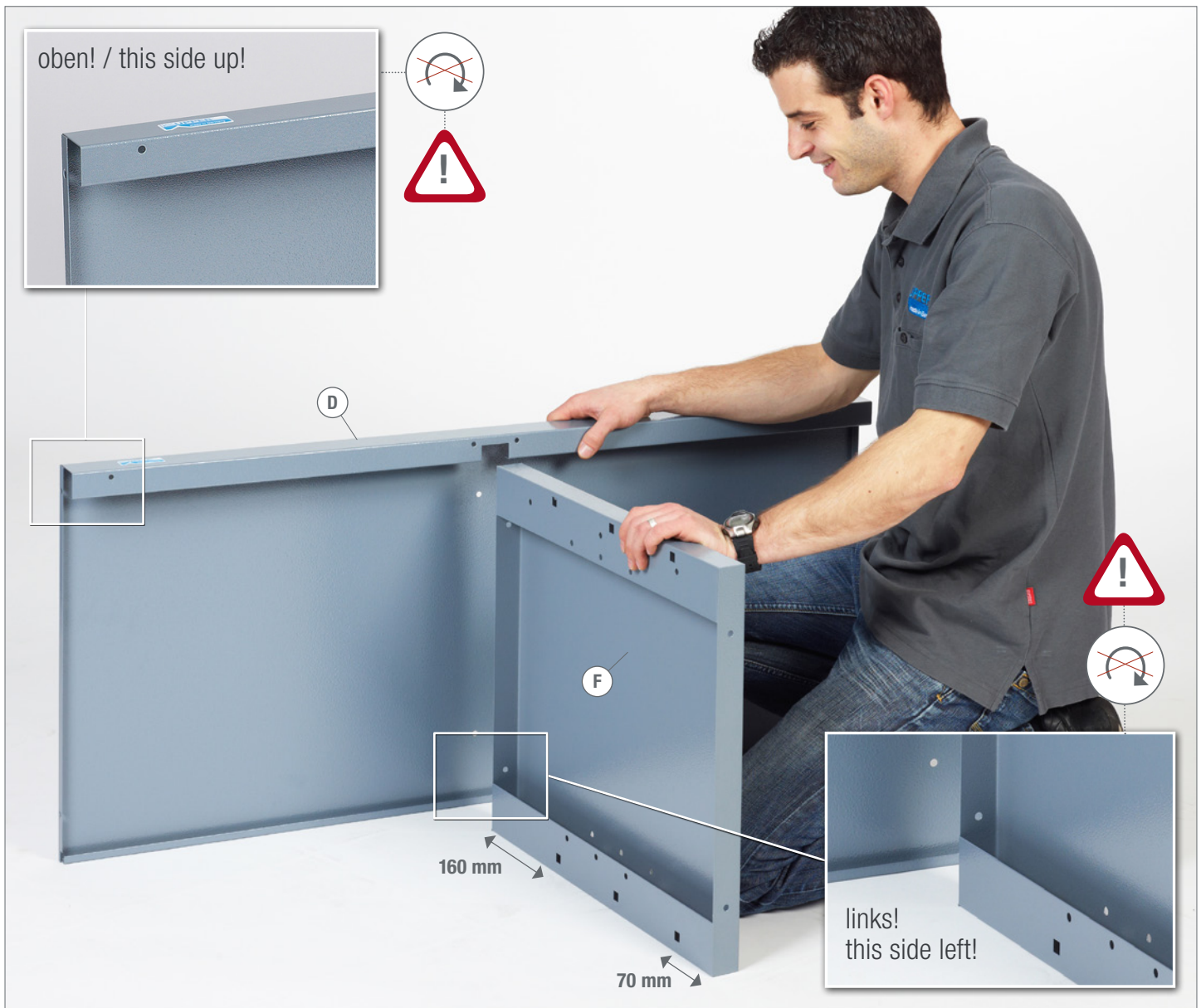

3.  2x M5  2x M5 x 10  2x 5,3 MM

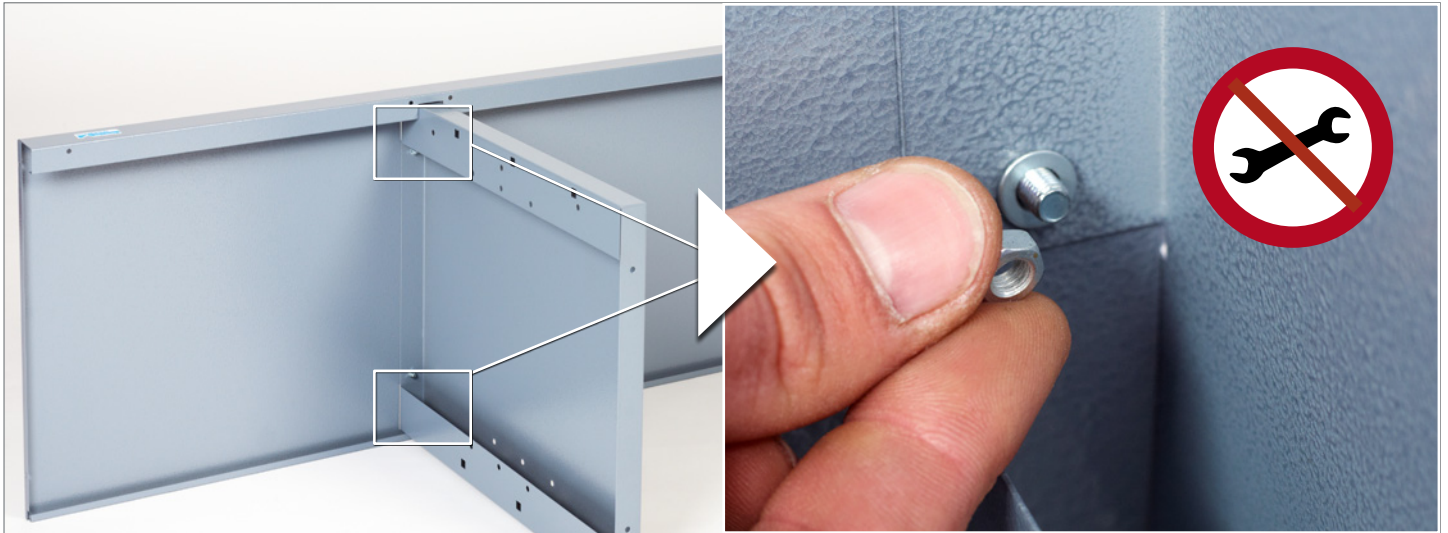

4.

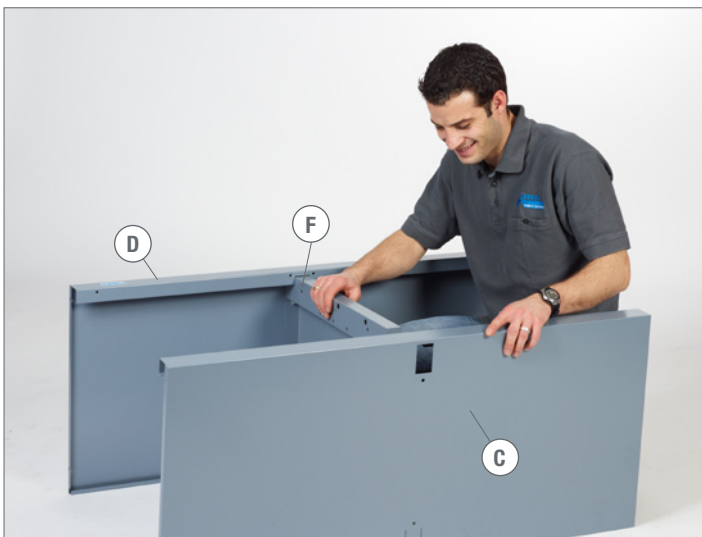

5.  2x M5  2x M5 x 10  2x 5,3 MM  ② SW 8  ① PH 2 X 100



6.



7.

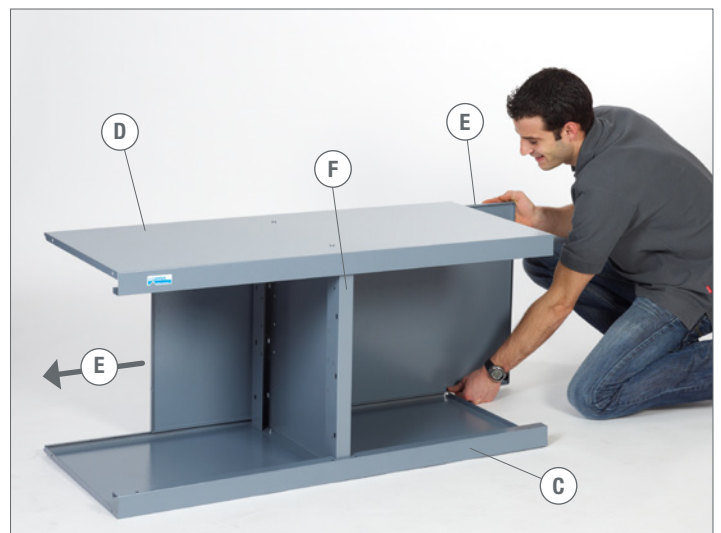

ZU SCHRITT 3. / IN ADDITION TO STEP 3.

②  SW 8    ①  PH 2x100

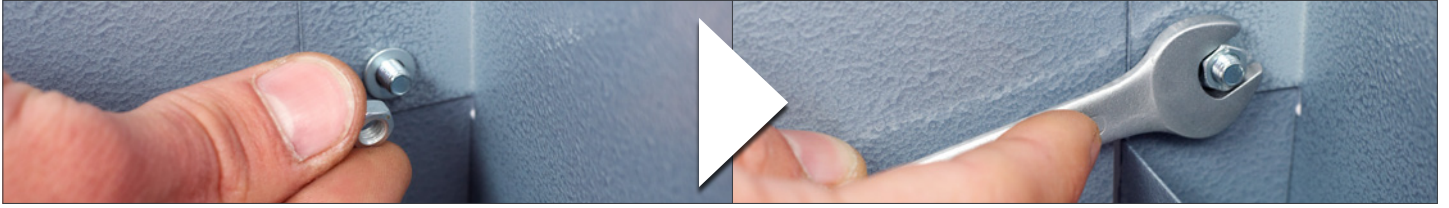

8. WICHTIG / IMPORTANT



9. WICHTIG / IMPORTANT

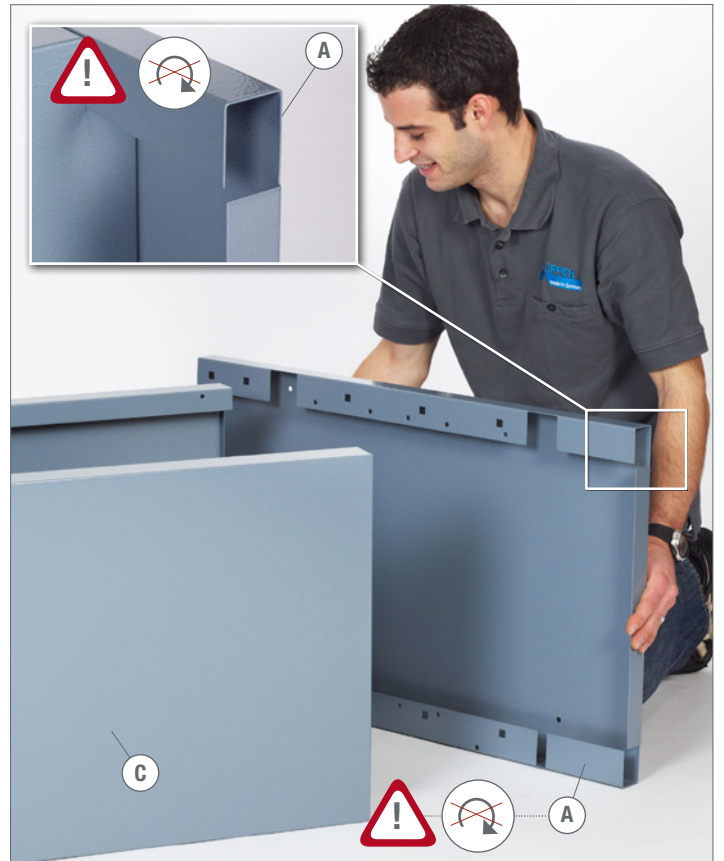

10.  6x M5     6x M5 x 10     6x 5,3MM    ②  SW 8    ①  PH 2x100



11.  6x M5     6x M5 x 10     6x 5,3MM    ②  SW 8    ①  PH 2x100



12.



5



13.



2 SW 8  
1 PH 2x100



14.  1x  1x 6x12

 ① Schlitz 6,5x150

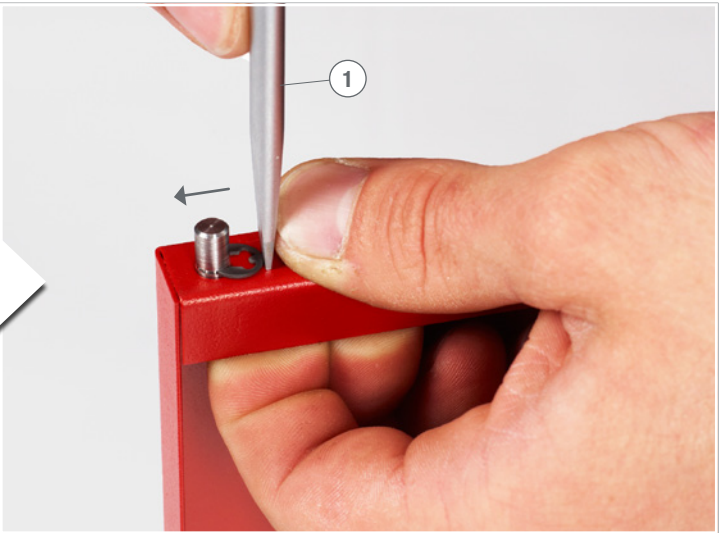

15.



16.  1x M6  1x M6x16  1x 6,4 mm  ② SW10  ⑥

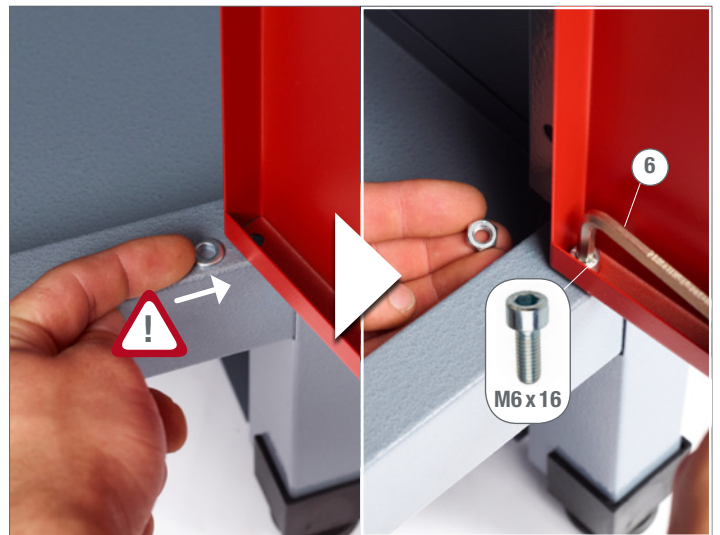

17.  1x  1x

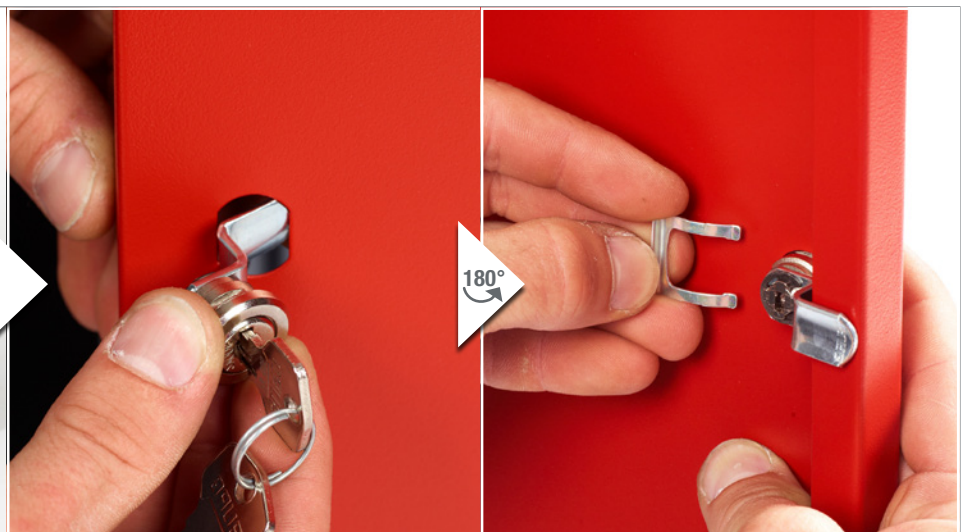



18.  3x CR



19.  3x CL

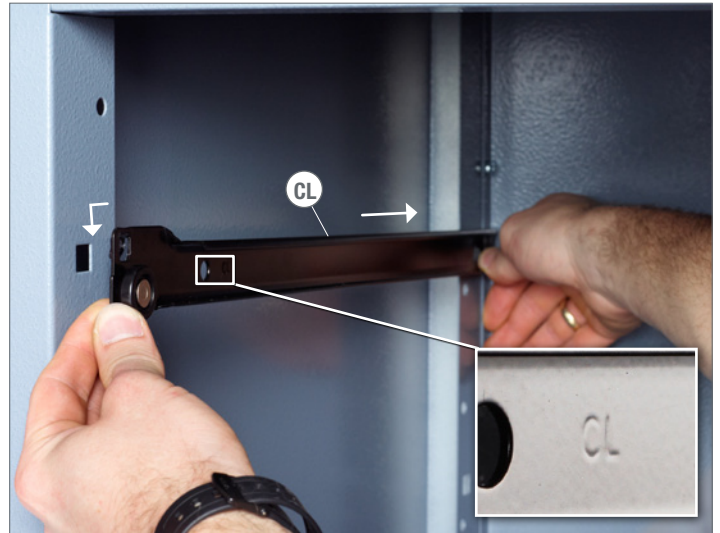

20.  6x M4  6x M4 x 10

 2 SW7  1 PH1 x 100



21.  18x M4  18x M4 x 10

 2 SW7  1 PH1 x 100

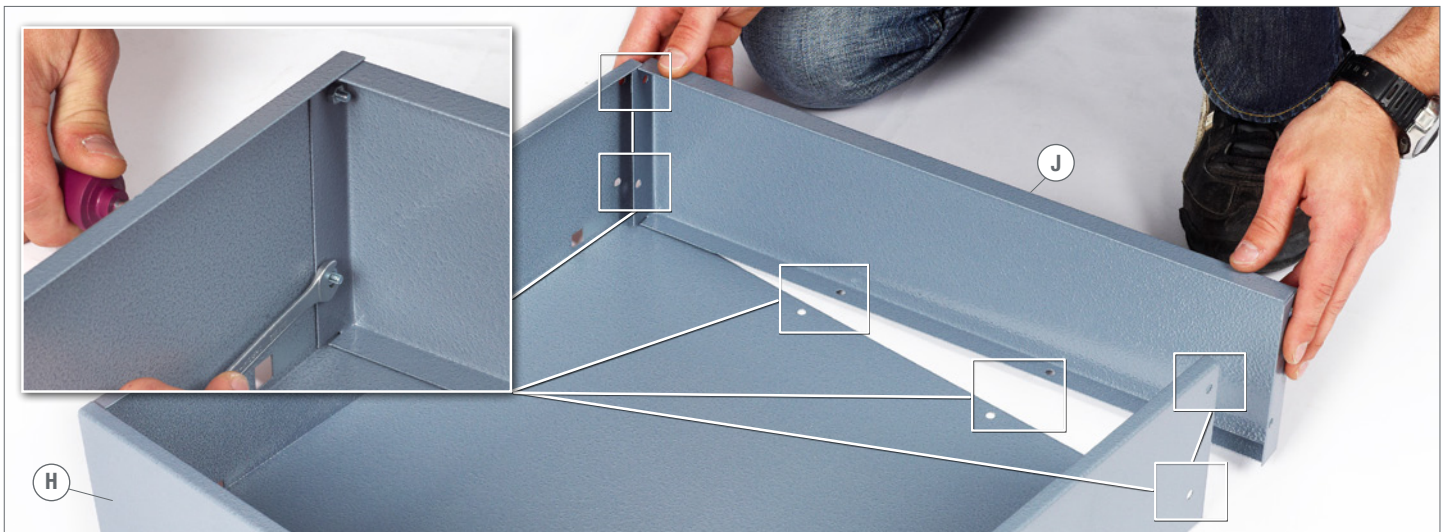

22.

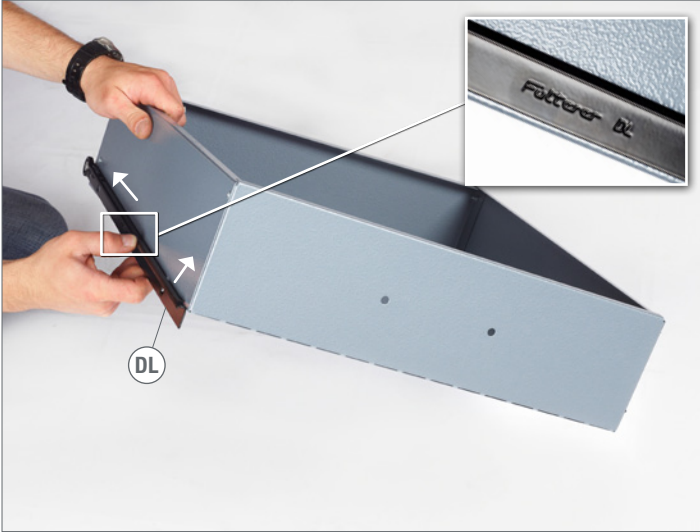

23.

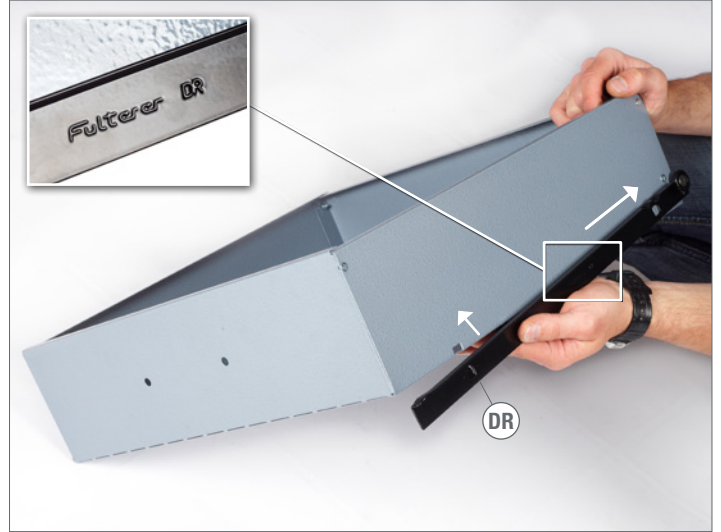

24.



25.

6x KU 4 x 16      3x       ①  PH 2 x 100



26.



27.



28.



29.

4x 5,5x 19





Modell-Nr.

**12080**