

Artikel-Nr.: 1082813

Bez.: Klinken Einbaubuchse 3,5mm 4-pol Print ohne Schalter

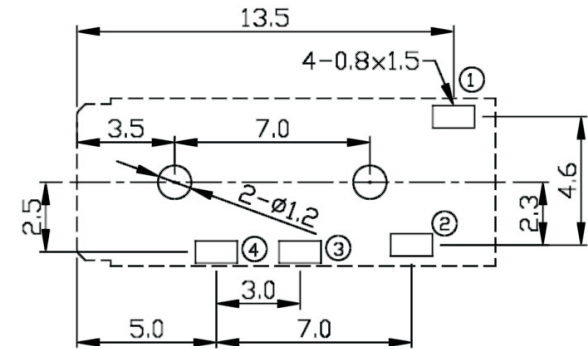

PCB LAYOUT
(BOTTOM VIEW)

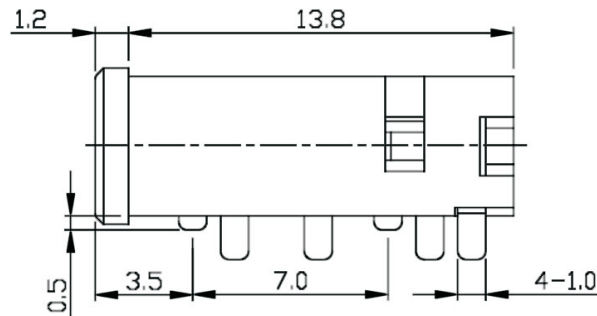
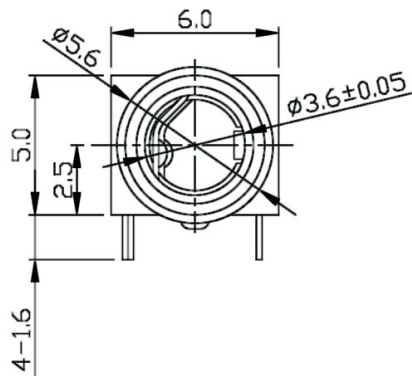
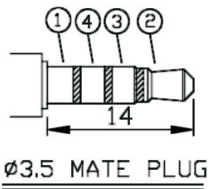
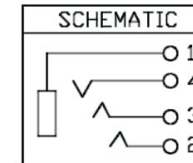
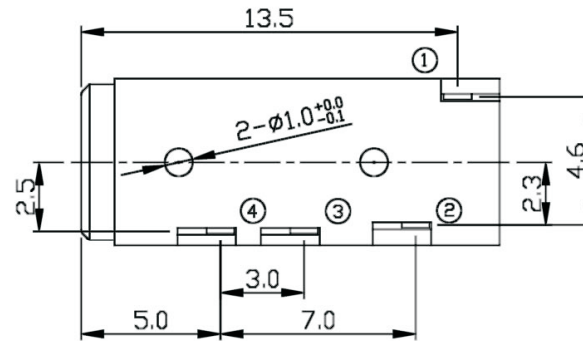
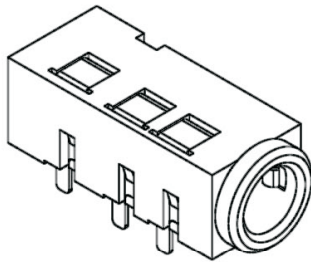

5	HOUSING	1	PA66		BLACK
4	TERMINAL 4	1	P.B.S	SILVER	
3	TERMINAL 3	1	P.B.S	SILVER	
2	TERMINAL 2	1	P.B.S	SILVER	
1	TERMINAL 1	1	P.B.S	SILVER	
NO	PART NAME	Q'TY	MATERIAL	PLATED	REMARK

www.bkl-electronic.de

Technische Änderungen vorbehalten. Ausführungen können variieren. Sollten Sie ein Muster benötigen kontaktieren Sie uns bitte.

BKL-ELECTRONIC Kreimendahl GmbH • Märkenstück 14 • 58509 Lüdenscheid
Tel: +49 (0)2351-3621-0 • Fax: +49 (0)2351-3621-29 • info@bkl-electronic.de

