

Artikel-Nr.: 1109005

Bez.: Klinken-Einbaubuchse 3,5 mm, mit Schalter, Printausf. 90°, hochwert. Ausf. Stereo

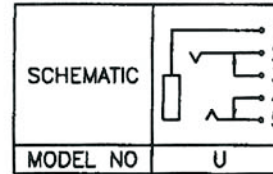
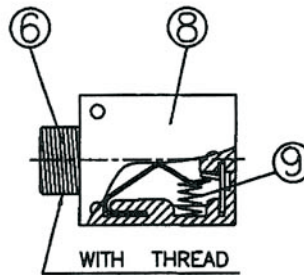
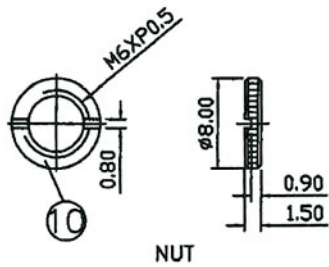

SPECIFICATIONS:

Contact Resistance : 30mΩ max  
 Insulation Resistance : 100MΩ min. at DC 500V  
 Dielectric Withstand Voltage : AC 500V for one minute  
 Remark: ▲: The Most Important Dimension

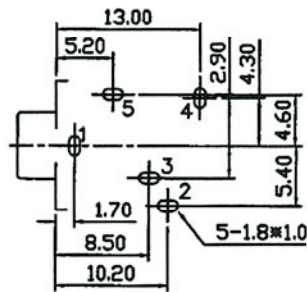
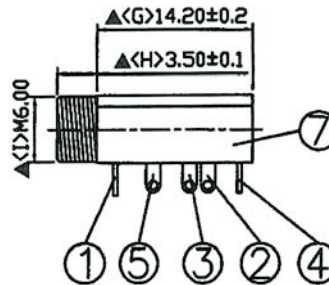
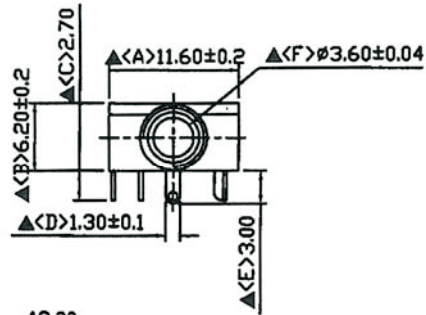

Pin Hole Layout  
(Jack Bottom View)

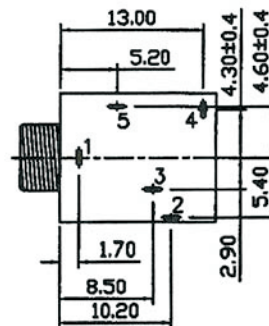

10	NUT	1.50T Brass	1	Nickel plated
9	Spring	SUS-304	1	
8	Cover	PC	1	Trans Parent
7	Housing	POM	1	Black Color
6	Barrel(W/Thread)	Brass	1	Nickel plated
5	Tip Spring	0.25T Phosphor Bronze	1	Silver Plated
4	Break Terminal	0.4T Brass	1	Silver Plated
3	Break Terminal	0.4T Brass	1	Silver Plated
2	Ring Spring	0.25T Phosphor Bronze	1	Silver Plated
1	Earth Terminal	0.4T Brass	1	Silver Plated
NO	Description	Material	Q'TY	Finish

[www.bkl-electronic.de](http://www.bkl-electronic.de)

Technische Änderungen vorbehalten. Ausführungen können variieren. Sollten Sie ein Muster benötigen kontaktieren Sie uns bitte.

BKL-ELECTRONIC Kreimendahl GmbH • Märkenstück 14 • 58509 Lüdenschaid  
 Tel: +49 (0)2351-3621-0 • Fax: +49 (0)2351-3621-29 • [info@bkl-electronic.de](mailto:info@bkl-electronic.de)

