

Verdrahtungsbausatz Federzug elektrisch und mechanisch elektrisch und mechanisch für Wendestarter S2









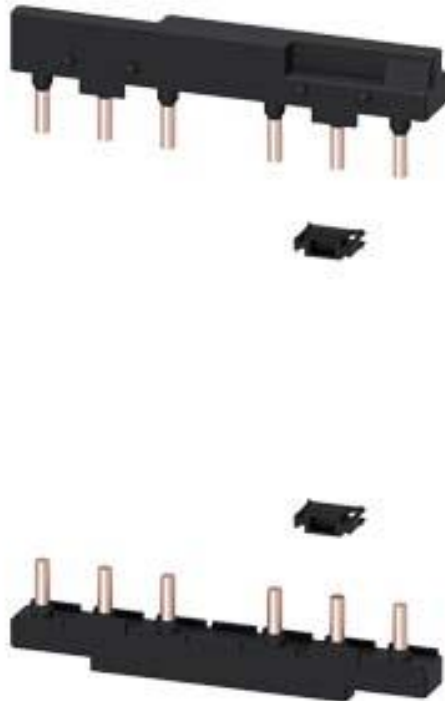

Abbildung ähnlich

Allgemeine technische Daten		
Produkt-Markename		SIRIUS
Produkt-Bezeichnung		Verdrahtungsbausatz
Ausführung des Produkts		Betätigungsspannung Schütz: AC und DC
Baugröße des Leistungsschalters		S2
Baugröße des Schützes		S2
Produktbestandteil Verdrahtungsbaustein unten		Ja
Produktbestandteil Verdrahtungsbaustein oben		Ja

Approbationen/Zertifikate

allgemeine Produktzulassung	Konformitätserklärung	Prüfbescheinigungen	Schiffbau
 CSA		 EG-Konf.	Typprüfbescheinigung/Werkszeugnis  ABS  BUREAU VERITAS

Schiffbau	sonstiges
 GL  RINA	Bestätigungen

Weitere Informationen

Information- and Downloadcenter (Kataloge, Broschüren,...)

<http://www.siemens.de/industrial-controls/catalogs>

Industry Mall (Online-Bestellsystem)

<https://mall.industry.siemens.com/mall/de/de/Catalog/product?mlfb=3RA2933-2AA2>

CAX-Online-Generator

<http://support.automation.siemens.com/WW/CAXorder/default.aspx?lang=de&mlfb=3RA2933-2AA2>

Service&Support (Handbücher, Betriebsanleitungen, Zertifikate, Kennlinien, FAQs,...)

<https://support.industry.siemens.com/cs/ww/de/ps/3RA2933-2AA2>

Bilddatenbank (Produktfotos, 2D-Maßzeichnungen, 3D-Modelle, Geräteschaltpläne, EPLAN Makros, ...)

http://www.automation.siemens.com/bilddb/cax_de.aspx?mlfb=3RA2933-2AA2&lang=de

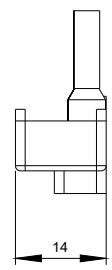
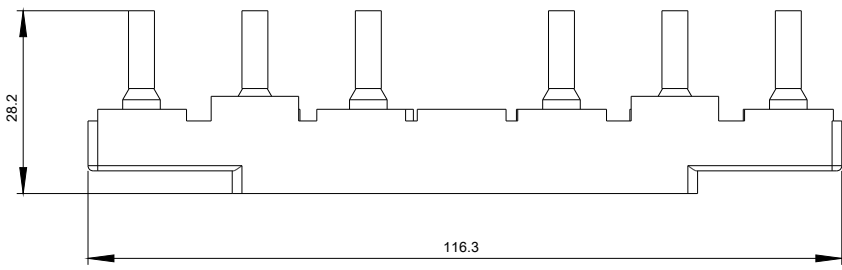
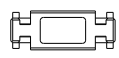
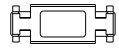
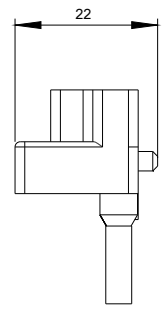
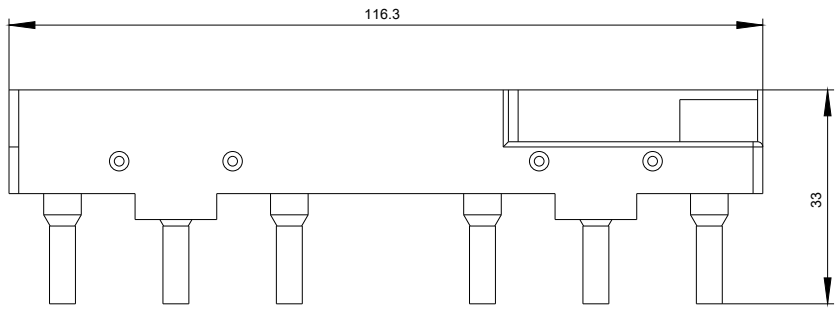

letzte Änderung:

29.06.2018