

Datenblatt | Artikelnummer: 2200-1201

2-Leiter-Durchgangsklemme; mit Drücker; 1 mm²; mit Prüföffnung; seitliche und mittige Beschriftung; für Tragschiene 35 x 15 und 35 x 7,5; Push-in CAGE CLAMP®

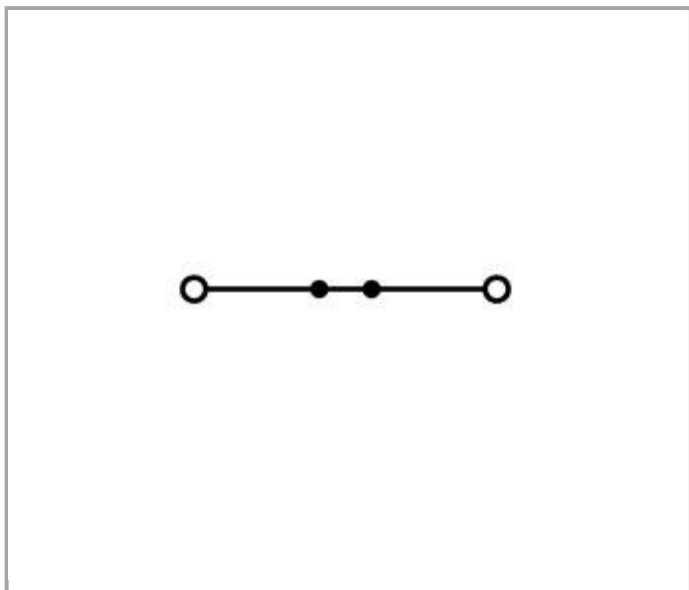

www.wago.com/2200-1201

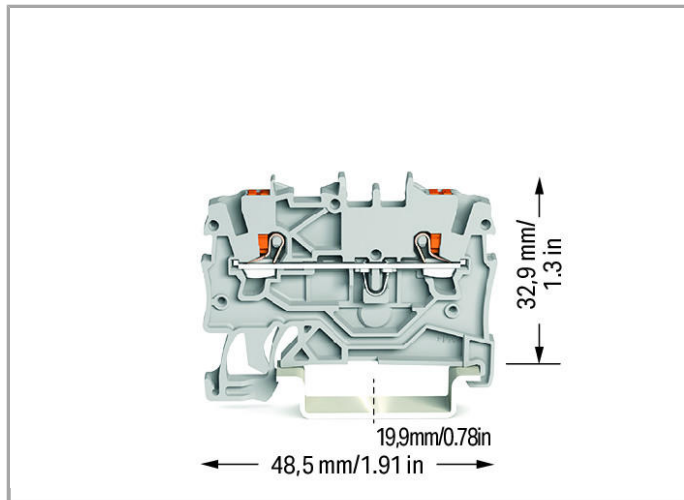
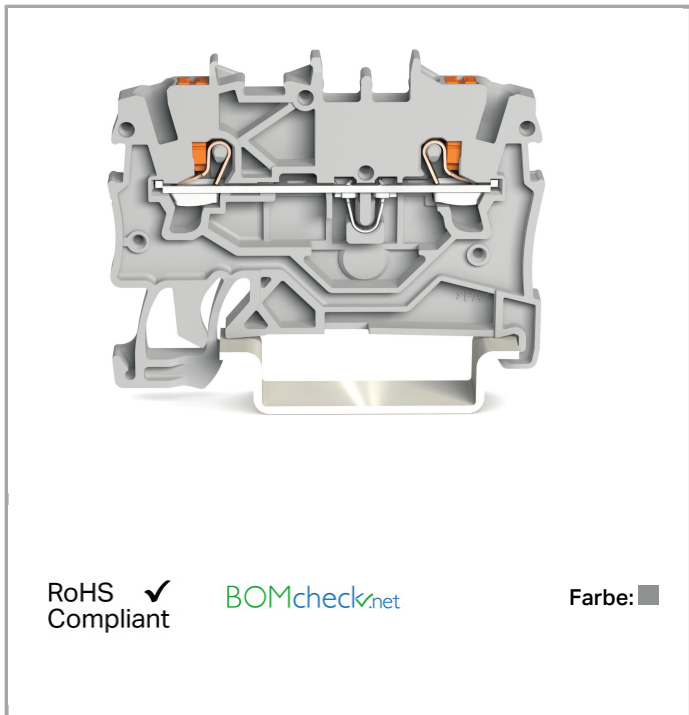

Daten
Elektrische Daten

Bemessungsdaten gemäß IEC/EN 60664-1

Bemessungsspannung (III / 3)	800 V
Bemessungsstoßspannung (III / 3)	8 kV
Bemessungsstrom	13.5 A
Bemessungsstrom 2	18 A
Legende Bemessungsdaten	(III / 3) \triangleq Überspannungskategorie III / Verschmutzungsgrad 3

Bemessungsdaten gemäß UL 1059

Bemessungsspannung UL (Use Group B)	600 V
Bemessungsstrom UL (Use Group B)	10 A
Bemessungsspannung UL (Use Group C)	600 V
Bemessungsstrom UL (Use Group C)	10 A

Anschlussdaten

Anschlusstechnik	Push-in CAGE CLAMP®
Betätigungsart	Push-in Drücker Betätigungswerkzeug
Anschließbare Leiterwerkstoffe	Kupfer
Nennquerschnitt	1 mm ²
Eindrähtiger Leiter	0,14 ... 1,5 mm ² / 24 ... 16 AWG
Eindrähtiger Leiter, direkt steckbar	0,5 ... 1,5 mm ² / 20 ... 16 AWG
Feindrähtiger Leiter	0,14 ... 1,5 mm ² / 24 ... 16 AWG
Feindrähtiger Leiter; mit Aderendhülse, direkt steckbar ab	0,5 mm ² / 20 AWG
Abisolierlänge	9 ... 11 mm / 0.35 ... 0.43 inch
Gesamte Anzahl der Klemmstellen	2
Gesamte Anzahl der Potentiale	1
Anzahl der Ebenen	1
Verdrahtungsart	Frontverdrahtung

Geometrische Daten

Breite	3,5 mm / 0.138 inch
Höhe ab Oberkante Tragschiene	32,9 mm / 1.295 inch
Tiefe	48,5 mm / 1.909 inch

Mechanische Daten

Bauform	horizontale Bauform
Montageart	Tragschiene 35
Beschriftungsebene	Mitten-/Seitliche Beschriftung

Werkstoffdaten

Farbe	grau
Isolierwerkstoff	Polyamid 66 (PA 66)
Gewicht	3.504 g

Kaufmännische Daten



Verpackungsart	Karton
Ursprungsland	DE
GTIN	4055143691543
Zolltarifnummer	85369010000

Zulassungen / Zertifikate

Ex-Zulassungen

Logo	Zulassung	Zertifikatsname
	AEx Underwriters Laboratories Inc.	4788311594
	ATEX Physikalisch Technische Bundesanstalt	PTB 18 ATEX 1003 U
	IECEX Physikalisch Technische Bundesanstalt	IECEX PTB 18.0010U (Ex eb IIC Gb and Ex eb I Mb)

Länderspezifische Zulassungen















Logo	Zulassung	Zertifikatsname
	CCA DEKRA Certification B.V.	NTR NL 7663
	KEMA/KEUR DEKRA Certification B.V.	71-102874

UL-Zulassungen

Logo	Zulassung	Zertifikatsname
	cURus Underwriters Laboratories Inc.	4788311592















Passende Produkte

Beschriftungsmaterial

	Art-Nr.: 2009-110 Beschriftungsstreifen; auf Rolle; nicht dehnbar; unbedruckt; aufrastbar	www.wago.com/2009-110
	Art-Nr.: 2009-113 WMB-Inline; für smartPRINTER; auf Rolle; unbedruckt; aufrastbar	www.wago.com/2009-113
	Art-Nr.: 2009-113/000-002 WMB-Inline; für smartPRINTER; auf Rolle; unbedruckt; aufrastbar	www.wago.com/2009-113/000-002
	Art-Nr.: 2009-113/000-005 WMB-Inline; für smartPRINTER; auf Rolle; unbedruckt; aufrastbar	www.wago.com/2009-113/000-005
	Art-Nr.: 2009-113/000-006 WMB-Inline; für smartPRINTER; auf Rolle; unbedruckt; aufrastbar	www.wago.com/2009-113/000-006
	Art-Nr.: 2009-113/000-007 WMB-Inline; für smartPRINTER; auf Rolle; unbedruckt; aufrastbar	www.wago.com/2009-113/000-007
	Art-Nr.: 2009-113/000-012 WMB-Inline; für smartPRINTER; auf Rolle; unbedruckt; aufrastbar	www.wago.com/2009-113/000-012
	Art-Nr.: 2009-113/000-017 WMB-Inline; für smartPRINTER; auf Rolle; unbedruckt; aufrastbar	www.wago.com/2009-113/000-017
	Art-Nr.: 2009-113/000-023 WMB-Inline; für smartPRINTER; auf Rolle; unbedruckt; aufrastbar	www.wago.com/2009-113/000-023
	Art-Nr.: 2009-113/000-024 WMB-Inline; für smartPRINTER; auf Rolle; unbedruckt; aufrastbar	www.wago.com/2009-113/000-024
	Art-Nr.: 2009-113/000-024 WMB-Inline; für smartPRINTER; auf Rolle; unbedruckt; aufrastbar	www.wago.com/2009-113/000-024
	Art-Nr.: 2009-113/000-024 WMB-Inline; für smartPRINTER; auf Rolle; unbedruckt; aufrastbar	www.wago.com/2009-113/000-024
	Art-Nr.: 2009-113/000-024 WMB-Inline; für smartPRINTER; auf Rolle; unbedruckt; aufrastbar	www.wago.com/2009-113/000-024
	Art-Nr.: 793-3501 WMB-Beschriftungskarte; als Karte; unbedruckt; aufrastbar	www.wago.com/793-3501

Brücker

	Art-Nr.: 2000-402 Kammbrücke; isoliert; 2-fach; Nennstrom 14 A	www.wago.com/2000-402
	Art-Nr.: 2000-402/000-005 Kammbrücke; isoliert; 2-fach; Nennstrom 14 A	www.wago.com/2000-402/000-005
	Art-Nr.: 2000-402/000-006 Kammbrücke; isoliert; 2-fach; Nennstrom 14 A	www.wago.com/2000-402/000-006

	Art-Nr.: 2000-402/000-018 Kammbrücker; isoliert; 2-fach; Nennstrom 14 A	www.wago.com/2000-402/000-018
	Art-Nr.: 2000-403 Kammbrücker; isoliert; 3-fach; Nennstrom 14 A	www.wago.com/2000-403
	Art-Nr.: 2000-403/000-005 Kammbrücker; isoliert; 3-fach; Nennstrom 14 A	www.wago.com/2000-403/000-005
	Art-Nr.: 2000-403/000-006 Kammbrücker; isoliert; 3-fach; Nennstrom 14 A	www.wago.com/2000-403/000-006
	Art-Nr.: 2000-404 Kammbrücker; isoliert; 4-fach; Nennstrom 14 A	www.wago.com/2000-404
	Art-Nr.: 2000-404/000-005 Kammbrücker; isoliert; 4-fach; Nennstrom 14 A	www.wago.com/2000-404/000-005
	Art-Nr.: 2000-404/000-006 Kammbrücker; isoliert; 4-fach; Nennstrom 14 A	www.wago.com/2000-404/000-006
	Art-Nr.: 2000-405 Kammbrücker; isoliert; 5-fach; Nennstrom 14 A	www.wago.com/2000-405
	Art-Nr.: 2000-405/000-005 Kammbrücker; isoliert; 5-fach; Nennstrom 14 A	www.wago.com/2000-405/000-005
	Art-Nr.: 2000-405/000-006 Kammbrücker; isoliert; 5-fach; Nennstrom 14 A	www.wago.com/2000-405/000-006
	Art-Nr.: 2000-405/011-000 Sternbrücker; isoliert; 3-fach (1-3-5); IN = IN Klemme	www.wago.com/2000-405/011-000
	Art-Nr.: 2000-406 Kammbrücker; isoliert; 6-fach; Nennstrom 14 A	www.wago.com/2000-406
	Art-Nr.: 2000-406/000-005 Kammbrücker; isoliert; 6-fach; Nennstrom 14 A	www.wago.com/2000-406/000-005
	Art-Nr.: 2000-406/000-006 Kammbrücker; isoliert; 6-fach; Nennstrom 14 A	www.wago.com/2000-406/000-006
	Art-Nr.: 2000-406/020-000 Dreieckbrücker; isoliert; 1-2 3-4 5-6; IN = IN Klemme	www.wago.com/2000-406/020-000
	Art-Nr.: 2000-407 Kammbrücker; isoliert; 7-fach; Nennstrom 14 A	www.wago.com/2000-407



Art-Nr.: 2000-407/000-005
Kammbrücker; isoliert; 7-fach; Nennstrom 14 A

www.wago.com/2000-407/000-005

Art-Nr.: 2000-407/000-006
Kammbrücker; isoliert; 7-fach; Nennstrom 14 A

www.wago.com/2000-407/000-006

Art-Nr.: 2000-408
Kammbrücker; isoliert; 8-fach; Nennstrom 14 A

www.wago.com/2000-408

Art-Nr.: 2000-408/000-005
Kammbrücker; isoliert; 8-fach; Nennstrom 14 A

www.wago.com/2000-408/000-005

Art-Nr.: 2000-408/000-006
Kammbrücker; isoliert; 8-fach; Nennstrom 14 A

www.wago.com/2000-408/000-006

Art-Nr.: 2000-409
Kammbrücker; isoliert; 9-fach; Nennstrom 14 A

www.wago.com/2000-409

Art-Nr.: 2000-409/000-005
Kammbrücker; isoliert; 9-fach; Nennstrom 14 A

www.wago.com/2000-409/000-005

Art-Nr.: 2000-409/000-006
Kammbrücker; isoliert; 9-fach; Nennstrom 14 A

www.wago.com/2000-409/000-006

Art-Nr.: 2000-410
Kammbrücker; isoliert; 10-fach; Nennstrom 14 A

www.wago.com/2000-410

Art-Nr.: 2000-410/000-005
Kammbrücker; isoliert; 10-fach; Nennstrom 14 A

www.wago.com/2000-410/000-005

Art-Nr.: 2000-410/000-006
Kammbrücker; isoliert; 10-fach; Nennstrom 14 A

www.wago.com/2000-410/000-006

Art-Nr.: 2000-433
Kammbrücker; isoliert; von 1 auf 3; Nennstrom 14 A

www.wago.com/2000-433

Art-Nr.: 2000-433/000-005
Kammbrücker; isoliert; von 1 auf 3; Nennstrom 14 A















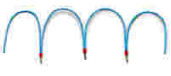

www.wago.com/2000-433/000-005

Art-Nr.: 2000-433/000-006
Kammbrücker; isoliert; von 1 auf 3; Nennstrom 14 A

www.wago.com/2000-433/000-006

Art-Nr.: 2000-434
Kammbrücker; isoliert; von 1 auf 4; Nennstrom 14 A

www.wago.com/2000-434

	Art-Nr.: 2000-435 Kammbrücke; isoliert; von 1 auf 5; Nennstrom 14 A	www.wago.com/2000-435
	Art-Nr.: 2000-436 Kammbrücke; isoliert; von 1 auf 6; Nennstrom 14 A	www.wago.com/2000-436
	Art-Nr.: 2000-437 Kammbrücke; isoliert; von 1 auf 7; Nennstrom 14 A	www.wago.com/2000-437
	Art-Nr.: 2000-438 Kammbrücke; isoliert; von 1 auf 8; Nennstrom 14 A	www.wago.com/2000-438
	Art-Nr.: 2000-439 Kammbrücke; isoliert; von 1 auf 9; Nennstrom 14 A	www.wago.com/2000-439
	Art-Nr.: 2000-440 Kammbrücke; isoliert; von 1 auf 10; Nennstrom 14 A	www.wago.com/2000-440
	Art-Nr.: 2009-402 Steckbarer Leitungsbrücke; isoliert; L = 60 mm; Leitungsquerschnitt 0,75 mm ² ; passend zu Reihenklemmen der Serien 2000 und 2020	www.wago.com/2009-402
	Art-Nr.: 2009-404 Steckbarer Leitungsbrücke; isoliert; L = 110 mm; Leitungsquerschnitt 0,75 mm ² ; passend zu Reihenklemmen der Serien 2000 und 2020	www.wago.com/2009-404
	Art-Nr.: 2009-406 Steckbarer Leitungsbrücke; isoliert; L = 250 mm; Leitungsquerschnitt 0,75 mm ² ; passend zu Reihenklemmen der Serien 2000 und 2020	www.wago.com/2009-406
	Art-Nr.: 210-103 Drahtkettenbrücke; isoliert; 50 Anschlüsse	www.wago.com/210-103
	Art-Nr.: 210-123 Drahtkettenbrücke; isoliert; 50 Anschlüsse	www.wago.com/210-123
Tragschiene		
	Art-Nr.: 210-112 Stahltragschiene; 35 x 7,5 mm; 1 mm dick; 2 m lang; gelocht; entsprechend EN 60715; Lochbreite 25 mm; Lochabstand 36 mm	www.wago.com/210-112
	Art-Nr.: 210-113 Stahltragschiene; 35 x 7,5 mm; 1 mm dick; 2 m lang; ungelocht; entsprechend EN 60715	www.wago.com/210-113
	Art-Nr.: 210-114 Stahltragschiene; 35 x 15 mm; 1,5 mm dick; 2 m lang; ungelocht; ähnlich EN 60715	www.wago.com/210-114
	Art-Nr.: 210-115 Stahltragschiene; 35 x 7,5 mm; 1 mm dick; 2 m lang; gelocht; entsprechend EN 60715; Lochbreite 18 mm; Lochabstand 25 mm	www.wago.com/210-115
	Art-Nr.: 210-118 Stahltragschiene; 35 x 15 mm; 2,3 mm dick; 2 m lang; ungelocht; entsprechend EN 60715	www.wago.com/210-118
	Art-Nr.: 210-196 Aluminiumtragschiene; 35 x 8,2 mm; 1,6 mm dick; 2 m lang; ungelocht; ähnlich EN 60715	www.wago.com/210-196
	Art-Nr.: 210-197 Stahltragschiene; 35 x 15 mm; 1,5 mm dick; 2 m lang; gelocht; ähnlich EN 60715	www.wago.com/210-197
	Art-Nr.: 210-198	



Kupfertragschiene; 35 x 15 mm; 2,3 mm dick; 2 m lang; ungelocht; entsprechend EN 60715

www.wago.com/210-198

Abschlussplatte



Art-Nr.: 2000-1291
Abschluss- und Zwischenplatte; 0,7 mm dick

www.wago.com/2000-1291



Art-Nr.: 2000-1292
Abschluss- und Zwischenplatte; 0,7 mm dick

www.wago.com/2000-1292

Aderendhülse



Art-Nr.: 216-241
Aderendhülse; Hülse für 0,5 mm² / AWG 22; mit Kunststoffkragen; galvanisch verzinkt; Elektrolytkupfer; gasdicht aufgecrimpt; gemäß DIN 46228, Teil 4/09.90

www.wago.com/216-241



Art-Nr.: 216-242
Aderendhülse; Hülse für 0,75 mm² / AWG 20; mit Kunststoffkragen; galvanisch verzinkt; Elektrolytkupfer; gasdicht aufgecrimpt; gemäß DIN 46228, Teil 4/09.90

www.wago.com/216-242



Art-Nr.: 216-243
Aderendhülse; Hülse für 1 mm² / AWG 18; mit Kunststoffkragen; galvanisch verzinkt; Elektrolytkupfer; gasdicht aufgecrimpt; gemäß DIN 46228, Teil 4/09.90

www.wago.com/216-243

Werkzeug



Art-Nr.: 210-647
Betätigungswerkzeug mit teilisoliertem Schaft; Klinge (2,5 x 0,4) mm; kurz

www.wago.com/210-647



Art-Nr.: 210-648
Betätigungswerkzeug mit teilisoliertem Schaft; Klinge (2,5 x 0,4) mm; kurz; abgewinkelt

www.wago.com/210-648



Art-Nr.: 210-719
Betätigungswerkzeug mit teilisoliertem Schaft; Typ 1, Klinge (2,5 x 0,4) mm

www.wago.com/210-719

Prüfen und Messen



Art-Nr.: 2000-510
TOPJOB®S-L-Prüfsteckermodul; anreihbar; für Brückerschlitze

www.wago.com/2000-510



Art-Nr.: 2000-511
TOPJOB®S-L-Prüfsteckermodul; anreihbar; für Brückerschlitze; 1-polig

www.wago.com/2000-511



Art-Nr.: 2000-549
Blindmodul; anreihbar; zum Überspringen von z. B. gebrückten Klemmen

www.wago.com/2000-549



Art-Nr.: 2000-552
Modularer TOPJOB®S-Steckverbinder; anreihbar; für Brückerschlitze; 2-polig

www.wago.com/2000-552



Art-Nr.: 2000-553
Modularer TOPJOB®S-Steckverbinder; anreihbar; für Brückerschlitze; 3-polig

www.wago.com/2000-553









Art-Nr.: 2000-554
Modularer TOPJOB®S-Steckverbinder; anreihbar; für Brückerschlitze; 4-polig

www.wago.com/2000-554

Art-Nr.: 2000-555
Modularer TOPJOB®S-Steckverbinder; anreihbar; für Brückerschlitze; 5-polig

www.wago.com/2000-555



	Art-Nr.: 2000-556 Modularer TOPJOB®S-Steckverbinder; anreihbar; für Brückerschlitze; 6-polig	www.wago.com/2000-556
	Art-Nr.: 2000-557 Modularer TOPJOB®S-Steckverbinder; anreihbar; für Brückerschlitze; 7-polig	www.wago.com/2000-557
	Art-Nr.: 2000-558 Modularer TOPJOB®S-Steckverbinder; anreihbar; für Brückerschlitze; 8-polig	www.wago.com/2000-558
	Art-Nr.: 2000-559 Modularer TOPJOB®S-Steckverbinder; anreihbar; für Brückerschlitze; 9-polig	www.wago.com/2000-559
	Art-Nr.: 2000-560 Modularer TOPJOB®S-Steckverbinder; anreihbar; für Brückerschlitze; 10-polig	www.wago.com/2000-560
	Art-Nr.: 2009-174 Prüfadapter; für Prüfstecker Ø 4 mm; zur Prüfung von TOPJOB®S-Reihenklennen	www.wago.com/2009-174
	Art-Nr.: 2009-182 Prüfabgriff; für max. 2,5 mm ² ; für den werkzeuglosen Anschluss individueller Prüflleitungen von 0,08 mm - 2,5 mm	www.wago.com/2009-182
	Art-Nr.: 210-136 Prüfstecker; Ø 2 mm; mit 500mm-Leitung	www.wago.com/210-136
	Art-Nr.: 210-137 Prüfstecker; Ø 2,3 mm; mit 500mm-Leitung	www.wago.com/210-137

Downloads

Dokumentation

Ausschreibungstext

2200-1201	Aug 15, 2018	DOCX 14,9 kB	Download
-----------	--------------	-----------------	----------

smartDATA

CAD Daten

3D Download 2200-1201	URL	Download
-----------------------	-----	----------



Produktfamilie

TOPJOB S

TOPJOB® S: Das breite und flexible Produktprogramm an Reihenklemmen bietet in diversen Industrieanwendungen und in der modernen Gebäudeinstallation mehr als nur eine sichere elektrische Verbindung.

[Mehr über die Produktfamilie erfahren](#)

[Alle Produkte der Familie anzeigen](#)

Änderungen vorbehalten.

WAGO Kontakttechnik GmbH & Co. KG
Hansastr. 27
32423 Minden
Telefon: +49571 887-0
E-Mail: info.de@wago.com | Web: www.wago.com

Haben Sie Fragen zu unseren Produkten?
Wir stehen Ihnen telefonisch unter +49 (571) 887-44222 gern zur
Verfügung.