

# Datenblatt | Artikelnummer: 2106-5201

2-Leiter-Durchgangsklemme; mit Hebel und Drücker; 6 mm<sup>2</sup>; mit Prüföffnung; seitliche und mittige Beschriftung; für Tragschiene 35 x 15 und 35 x 7,5; Push-in CAGE CLAMP®

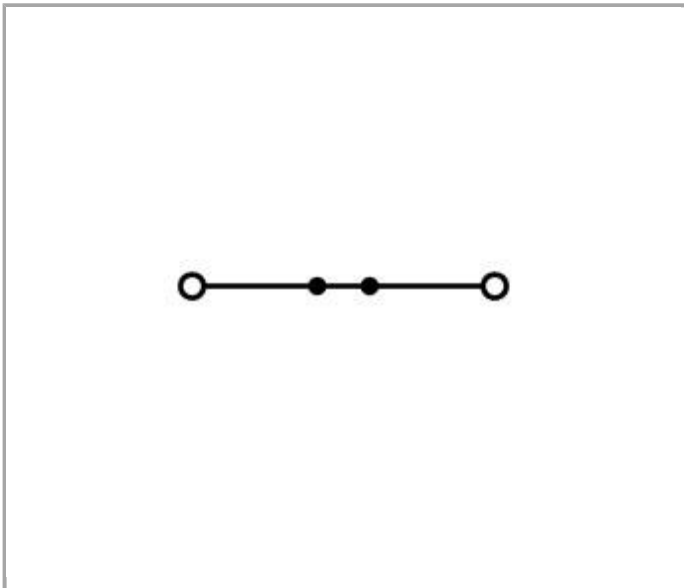

[www.wago.com/2106-5201](http://www.wago.com/2106-5201)

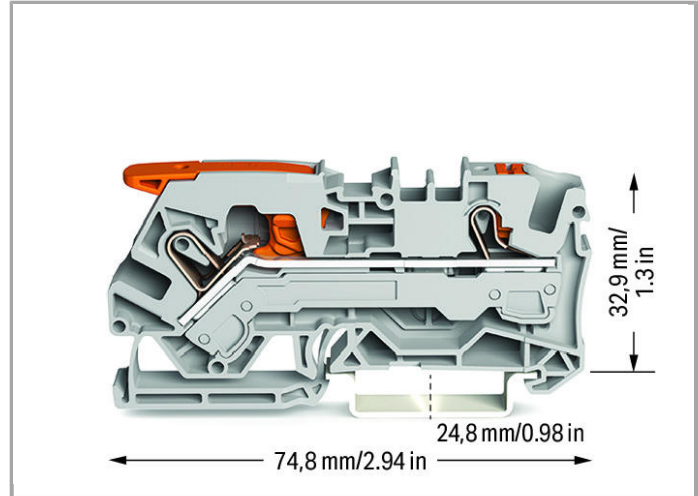
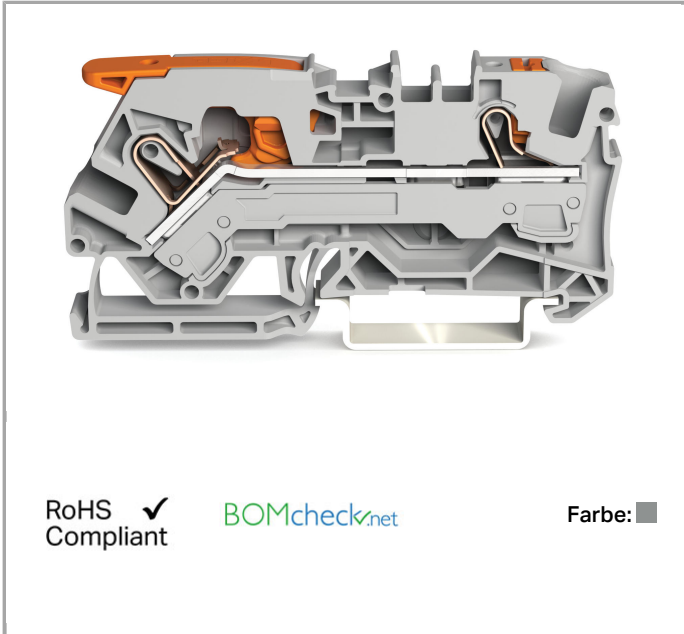

## Daten Elektrische Daten

### Bemessungsdaten gemäß IEC/EN 60664-1

Bemessungsspannung (III / 3)	800 V
Bemessungsstoßspannung (III / 3)	8 kV



Bemessungsstrom	41 A
Bemessungsstrom 2	57 A
Legende Bemessungsdaten	(III / 3) $\triangleq$ Überspannungskategorie III / Verschmutzungsgrad 3

### Anschlussdaten

Anschluss technik	Push-in CAGE CLAMP®
Betätigungsart	Push-in Hebel
Anschließbare Leiterwerkstoffe	Kupfer
Nennquerschnitt	6 mm <sup>2</sup>
Eindrähtiger Leiter	0,5 ... 10 mm <sup>2</sup> / 20 ... 8 AWG
Eindrähtiger Leiter, direkt steckbar	1 ... 10 mm <sup>2</sup> / 14 ... 8 AWG
Feindrähtiger Leiter	0,5 ... 10 mm <sup>2</sup> / 20 ... 8 AWG
Feindrähtiger Leiter; mit Aderendhülse, direkt steckbar ab	1,5 mm <sup>2</sup> / 16 AWG
Abisolierlänge	13 ... 15 mm / 0.51 ... 0.59 inch
Betätigungsart 2	Push-in Drücker Betätigungswerkzeug
Gesamte Anzahl der Klemmstellen	2
Gesamte Anzahl der Potentiale	1
Anzahl der Ebenen	1
Verdrahtungsart	Frontverdrahtung

### Geometrische Daten

Breite	7,5 mm / 0.295 inch
Höhe ab Oberkante Tragschiene	32,9 mm / 1.295 inch
Tiefe	74,8 mm / 2.945 inch

### Mechanische Daten

Bauform	horizontale Bauform
Montageart	Tragschiene 35
Beschriftungsebene	Mitten-/Seitliche Beschriftung

### Werkstoffdaten

Farbe	grau
Isolierwerkstoff	Polyamid 66 (PA 66)
Gewicht	14.2 g

### Kaufmännische Daten

Verpackungsart	Karton
----------------	--------

Ursprungsland	DE
GTIN	4055143742450
Zolltarifnummer	85369010000

## Zulassungen / Zertifikate

### Länderspezifische Zulassungen







Logo	Zulassung	Zertifikatsname
	<b>CCA</b> DEKRA Certification B.V.	NTR NL 7678
	<b>KEMA/KEUR</b> DEKRA Certification B.V.	71-103226

















### UL-Zulassungen

Logo	Zulassung	Zertifikatsname
	<b>UL</b> Underwriters Laboratories Inc.	20181005-E45172

## Passende Produkte

### Beschriftungsmaterial

	<b>Art-Nr.: 2009-110</b> Beschriftungstreifen; auf Rolle; nicht dehnbar; unbedruckt; aufrastbar	<a href="http://www.wago.com/2009-110">www.wago.com/2009-110</a>
	<b>Art-Nr.: 2009-115</b> WMB-Inline; für smartPRINTER; auf Rolle; dehnbar 5 - 5,2 mm; unbedruckt; aufrastbar	<a href="http://www.wago.com/2009-115">www.wago.com/2009-115</a>
	<b>Art-Nr.: 2009-115/000-002</b> WMB-Inline; für smartPRINTER; auf Rolle; dehnbar 5 - 5,2 mm; unbedruckt; aufrastbar	<a href="http://www.wago.com/2009-115/000-002">www.wago.com/2009-115/000-002</a>
	<b>Art-Nr.: 2009-115/000-006</b> WMB-Inline; für smartPRINTER; auf Rolle; dehnbar 5 - 5,2 mm; unbedruckt; aufrastbar	<a href="http://www.wago.com/2009-115/000-006">www.wago.com/2009-115/000-006</a>
	<b>Art-Nr.: 2009-115/000-007</b> WMB-Inline; für smartPRINTER; auf Rolle; dehnbar 5 - 5,2 mm; unbedruckt; aufrastbar	<a href="http://www.wago.com/2009-115/000-007">www.wago.com/2009-115/000-007</a>
	<b>Art-Nr.: 2009-115/000-012</b> WMB-Inline; für smartPRINTER; auf Rolle; dehnbar 5 - 5,2 mm; unbedruckt; aufrastbar	<a href="http://www.wago.com/2009-115/000-012">www.wago.com/2009-115/000-012</a>
	<b>Art-Nr.: 2009-115/000-017</b> WMB-Inline; für smartPRINTER; auf Rolle; dehnbar 5 - 5,2 mm; unbedruckt; aufrastbar	<a href="http://www.wago.com/2009-115/000-017">www.wago.com/2009-115/000-017</a>

	<b>Art-Nr.: 2009-115/000-023</b> WMB-Inline; für smartPRINTER; auf Rolle; dehnbar 5 - 5,2 mm; unbedruckt; aufrastbar	<a href="http://www.wago.com/2009-115/000-023">www.wago.com/2009-115/000-023</a>
	<b>Art-Nr.: 2009-115/000-024</b> WMB-Inline; für smartPRINTER; auf Rolle; dehnbar 5 - 5,2 mm; unbedruckt; aufrastbar	<a href="http://www.wago.com/2009-115/000-024">www.wago.com/2009-115/000-024</a>
	<b>Art-Nr.: 2009-145</b> Mini-WSB Inline; für smartPRINTER; auf Rolle; dehnbar 5 - 5,2 mm; unbedruckt; aufrastbar	<a href="http://www.wago.com/2009-145">www.wago.com/2009-145</a>
	<b>Art-Nr.: 2009-145/000-002</b> Mini-WSB Inline; für smartPRINTER; auf Rolle; dehnbar 5 - 5,2 mm; unbedruckt; aufrastbar	<a href="http://www.wago.com/2009-145/000-002">www.wago.com/2009-145/000-002</a>
	<b>Art-Nr.: 2009-145/000-005</b> Mini-WSB Inline; für smartPRINTER; auf Rolle; dehnbar 5 - 5,2 mm; unbedruckt; aufrastbar	<a href="http://www.wago.com/2009-145/000-005">www.wago.com/2009-145/000-005</a>
	<b>Art-Nr.: 2009-145/000-006</b> Mini-WSB Inline; für smartPRINTER; auf Rolle; dehnbar 5 - 5,2 mm; unbedruckt; aufrastbar	<a href="http://www.wago.com/2009-145/000-006">www.wago.com/2009-145/000-006</a>
	<b>Art-Nr.: 2009-145/000-007</b> Mini-WSB Inline; für smartPRINTER; auf Rolle; dehnbar 5 - 5,2 mm; unbedruckt; aufrastbar	<a href="http://www.wago.com/2009-145/000-007">www.wago.com/2009-145/000-007</a>
	<b>Art-Nr.: 2009-145/000-012</b> Mini-WSB Inline; für smartPRINTER; auf Rolle; dehnbar 5 - 5,2 mm; unbedruckt; aufrastbar	<a href="http://www.wago.com/2009-145/000-012">www.wago.com/2009-145/000-012</a>
	<b>Art-Nr.: 2009-145/000-023</b> Mini-WSB Inline; für smartPRINTER; auf Rolle; dehnbar 5 - 5,2 mm; unbedruckt; aufrastbar	<a href="http://www.wago.com/2009-145/000-023">www.wago.com/2009-145/000-023</a>
	<b>Art-Nr.: 2009-145/000-024</b> Mini-WSB Inline; auf Rolle; dehnbar 5 - 5,2 mm; unbedruckt; aufrastbar	<a href="http://www.wago.com/2009-145/000-024">www.wago.com/2009-145/000-024</a>
	<b>Art-Nr.: 2009-191</b> Gruppenschildträger	<a href="http://www.wago.com/2009-191">www.wago.com/2009-191</a>
	<b>Art-Nr.: 2009-192</b> Gruppenschildträger	<a href="http://www.wago.com/2009-192">www.wago.com/2009-192</a>
	<b>Art-Nr.: 2009-193</b> Gruppenschildträger	<a href="http://www.wago.com/2009-193">www.wago.com/2009-193</a>
	<b>Art-Nr.: 2009-198</b> Adapter	<a href="http://www.wago.com/2009-198">www.wago.com/2009-198</a>
	<b>Art-Nr.: 248-501</b> Mini-WSB-Schnellbeschriftungssystem; unbedruckt; Schildchenbreite 5 mm; 10 Streifen à 10 Schilder pro Karte	<a href="http://www.wago.com/248-501">www.wago.com/248-501</a>
	<b>Art-Nr.: 248-501/000-002</b> Mini-WSB-Beschriftungskarte; als Karte; nicht dehnbar; unbedruckt; aufrastbar	<a href="http://www.wago.com/248-501/000-002">www.wago.com/248-501/000-002</a>



**Art-Nr.: 248-501/000-005**  
Mini-WSB-Beschriftungskarte; als Karte; unbedruckt; aufrastbar

[www.wago.com/248-501/000-005](http://www.wago.com/248-501/000-005)



**Art-Nr.: 248-501/000-006**  
Mini-WSB-Beschriftungskarte; als Karte; nicht dehnbar; unbedruckt; aufrastbar

[www.wago.com/248-501/000-006](http://www.wago.com/248-501/000-006)



**Art-Nr.: 248-501/000-007**  
Mini-WSB-Beschriftungskarte; als Karte; nicht dehnbar; unbedruckt; aufrastbar

[www.wago.com/248-501/000-007](http://www.wago.com/248-501/000-007)



**Art-Nr.: 248-501/000-012**  
Mini-WSB-Beschriftungskarte; als Karte; nicht dehnbar; unbedruckt; aufrastbar

[www.wago.com/248-501/000-012](http://www.wago.com/248-501/000-012)



**Art-Nr.: 248-501/000-017**  
Mini-WSB-Beschriftungskarte; als Karte; nicht dehnbar; unbedruckt; aufrastbar

[www.wago.com/248-501/000-017](http://www.wago.com/248-501/000-017)



**Art-Nr.: 248-501/000-023**  
Mini-WSB-Beschriftungskarte; als Karte; nicht dehnbar; unbedruckt; aufrastbar

[www.wago.com/248-501/000-023](http://www.wago.com/248-501/000-023)



**Art-Nr.: 248-501/000-024**  
Mini-WSB-Beschriftungskarte; als Karte; nicht dehnbar; unbedruckt; aufrastbar

[www.wago.com/248-501/000-024](http://www.wago.com/248-501/000-024)



**Art-Nr.: 793-501**  
WMB-Beschriftungskarte; als Karte; nicht dehnbar; unbedruckt; aufrastbar

[www.wago.com/793-501](http://www.wago.com/793-501)



**Art-Nr.: 793-501/000-002**  
WMB-Beschriftungskarte; als Karte; nicht dehnbar; unbedruckt; aufrastbar

[www.wago.com/793-501/000-002](http://www.wago.com/793-501/000-002)



**Art-Nr.: 793-501/000-005**  
WMB-Beschriftungskarte; als Karte; nicht dehnbar; unbedruckt; aufrastbar

[www.wago.com/793-501/000-005](http://www.wago.com/793-501/000-005)



**Art-Nr.: 793-501/000-006**  
WMB-Beschriftungskarte; als Karte; nicht dehnbar; unbedruckt; aufrastbar

[www.wago.com/793-501/000-006](http://www.wago.com/793-501/000-006)



**Art-Nr.: 793-501/000-007**  
WMB-Beschriftungskarte; als Karte; nicht dehnbar; unbedruckt; aufrastbar

[www.wago.com/793-501/000-007](http://www.wago.com/793-501/000-007)



**Art-Nr.: 793-501/000-012**  
WMB-Beschriftungskarte; als Karte; nicht dehnbar; unbedruckt; aufrastbar

[www.wago.com/793-501/000-012](http://www.wago.com/793-501/000-012)



**Art-Nr.: 793-501/000-017**  
WMB-Beschriftungskarte; als Karte; nicht dehnbar; unbedruckt; aufrastbar

[www.wago.com/793-501/000-017](http://www.wago.com/793-501/000-017)



**Art-Nr.: 793-501/000-023**  
WMB-Beschriftungskarte; als Karte; nicht dehnbar; unbedruckt; aufrastbar

[www.wago.com/793-501/000-023](http://www.wago.com/793-501/000-023)



**Art-Nr.: 793-501/000-024**  
WMB-Beschriftungskarte; als Karte; nicht dehnbar; unbedruckt; aufrastbar

[www.wago.com/793-501/000-024](http://www.wago.com/793-501/000-024)



**Art-Nr.: 793-5501**  
WMB-Beschriftungskarte; als Karte; für Klemmenbreite 5 - 17,5 mm; dehnbar 5 - 5,2 mm; unbedruckt; aufrastbar

[www.wago.com/793-5501](http://www.wago.com/793-5501)



**Art-Nr.: 793-5501/000-002**  
WMB-Beschriftungskarte; als Karte; für Klemmenbreite 5 - 17,5 mm; dehnbar 5 - 5,2 mm; unbedruckt; aufrastbar

[www.wago.com/793-5501/000-002](http://www.wago.com/793-5501/000-002)



**Art-Nr.: 793-5501/000-005**  
WMB-Beschriftungskarte; als Karte; dehnbar 5 - 5,2 mm; unbedruckt; aufrastbar

[www.wago.com/793-5501/000-005](http://www.wago.com/793-5501/000-005)



**Art-Nr.: 793-5501/000-006**  
WMB-Beschriftungskarte; als Karte; dehnbar 5 - 5,2 mm; unbedruckt; aufrastbar

[www.wago.com/793-5501/000-006](http://www.wago.com/793-5501/000-006)



**Art-Nr.: 793-5501/000-007**  
WMB-Beschriftungskarte; als Karte; dehnbar 5 - 5,2 mm; unbedruckt; aufrastbar

[www.wago.com/793-5501/000-007](http://www.wago.com/793-5501/000-007)



**Art-Nr.: 793-5501/000-012**  
WMB-Beschriftungskarte; als Karte; dehnbar 5 - 5,2 mm; unbedruckt; aufrastbar

[www.wago.com/793-5501/000-012](http://www.wago.com/793-5501/000-012)



**Art-Nr.: 793-5501/000-017**  
WMB-Beschriftungskarte; als Karte; dehnbar 5 - 5,2 mm; unbedruckt; aufrastbar

[www.wago.com/793-5501/000-017](http://www.wago.com/793-5501/000-017)



**Art-Nr.: 793-5501/000-023**  
WMB-Beschriftungskarte; als Karte; dehnbar 5 - 5,2 mm; unbedruckt; aufrastbar

[www.wago.com/793-5501/000-023](http://www.wago.com/793-5501/000-023)



**Art-Nr.: 793-5501/000-024**  
WMB-Beschriftungskarte; als Karte; dehnbar 5 - 5,2 mm; unbedruckt; aufrastbar

[www.wago.com/793-5501/000-024](http://www.wago.com/793-5501/000-024)

## Brücker



**Art-Nr.: 2006-402**  
Kammbrücker; isoliert; 2-fach; Nennstrom 41 A

[www.wago.com/2006-402](http://www.wago.com/2006-402)



**Art-Nr.: 2006-403**  
Kammbrücker; isoliert; 3-fach; Nennstrom 41 A

[www.wago.com/2006-403](http://www.wago.com/2006-403)



**Art-Nr.: 2006-404**  
Kammbrücker; isoliert; 4-fach; Nennstrom 41 A

[www.wago.com/2006-404](http://www.wago.com/2006-404)



**Art-Nr.: 2006-405**  
Kammbrücker; isoliert; 5-fach; Nennstrom 41 A

[www.wago.com/2006-405](http://www.wago.com/2006-405)



**Art-Nr.: 2006-405/011-000**  
Sternbrücker; isoliert; 3-fach (1-3-5); IN = IN Klemme

[www.wago.com/2006-405/011-000](http://www.wago.com/2006-405/011-000)

**Art-Nr.: 2006-433**

	Kammbrücke; isoliert; von 1 auf 3; Nennstrom 41 A	<a href="http://www.wago.com/2006-433">www.wago.com/2006-433</a>
--	---	--

	<b>Art-Nr.: 2006-434</b> Kammbrücke; isoliert; von 1 auf 4; Nennstrom 41 A	<a href="http://www.wago.com/2006-434">www.wago.com/2006-434</a>
--	---	--

	<b>Art-Nr.: 2006-435</b> Kammbrücke; isoliert; von 1 auf 5; Nennstrom 41 A	<a href="http://www.wago.com/2006-435">www.wago.com/2006-435</a>
--	---	--

	<b>Art-Nr.: 2006-499</b> Reduzierbrücke; isoliert; von 6/4 mm <sup>2</sup> auf 4/2,5/1,5 mm <sup>2</sup> ; Nennstrom 32 A	<a href="http://www.wago.com/2006-499">www.wago.com/2006-499</a>
--	--	--

	<b>Art-Nr.: 2016-499</b> Reduzierbrücke; isoliert; von 16/10 mm <sup>2</sup> auf 10/6/4/2,5 mm <sup>2</sup> ; Nennstrom 57 A	<a href="http://www.wago.com/2016-499">www.wago.com/2016-499</a>
--	---	--

	<b>Art-Nr.: 210-103</b> Drahtkettenbrücke; isoliert; 50 Anschlüsse	<a href="http://www.wago.com/210-103">www.wago.com/210-103</a>
--	---	--

	<b>Art-Nr.: 210-123</b> Drahtkettenbrücke; isoliert; 50 Anschlüsse	<a href="http://www.wago.com/210-123">www.wago.com/210-123</a>
--	---	--

#### Werkzeug

	<b>Art-Nr.: 210-721</b> Betätigungswerkzeug mit teilisoliertem Schaft; Typ 3, Klinge (5,5 x 0,8) mm	<a href="http://www.wago.com/210-721">www.wago.com/210-721</a>
--	--	--

#### Allgemeines Zubehör

	<b>Art-Nr.: 2006-191</b> Verschlusskappe; Signalverteiler	<a href="http://www.wago.com/2006-191">www.wago.com/2006-191</a>
--	--	--

#### Aderendhülse

	<b>Art-Nr.: 216-208</b> Aderendhülse; Hülse für 6 mm <sup>2</sup> / AWG 10; mit Kunststoffkragen; galvanisch verzinkt; Elektrolytkupfer; gasdicht aufgecrimpt; gemäß DIN 46228, Teil 4/09.90	<a href="http://www.wago.com/216-208">www.wago.com/216-208</a>
--	---	--

	<b>Art-Nr.: 216-262</b> Aderendhülse; Hülse für 0,75 mm <sup>2</sup> / AWG 20; mit Kunststoffkragen; galvanisch verzinkt; Elektrolytkupfer; gasdicht aufgecrimpt; gemäß DIN 46228, Teil 4/09.90	<a href="http://www.wago.com/216-262">www.wago.com/216-262</a>
--	--	--

	<b>Art-Nr.: 216-263</b> Aderendhülse; Hülse für 1 mm <sup>2</sup> / AWG 18; mit Kunststoffkragen; galvanisch verzinkt; Elektrolytkupfer; gasdicht aufgecrimpt; gemäß DIN 46228, Teil 4/09.90	<a href="http://www.wago.com/216-263">www.wago.com/216-263</a>
--	---	--





	<b>Art-Nr.: 216-264</b> Aderendhülse; Hülse für 1,5 mm <sup>2</sup> / AWG 16; mit Kunststoffkragen; galvanisch verzinkt; Elektrolytkupfer; gasdicht aufgecrimpt; gemäß DIN 46228, Teil 4/09.90	<a href="http://www.wago.com/216-264">www.wago.com/216-264</a>
--	---	--

	<b>Art-Nr.: 216-266</b> Aderendhülse; Hülse für 2,5 mm <sup>2</sup> / AWG 14; mit Kunststoffkragen; galvanisch verzinkt; Elektrolytkupfer; gasdicht aufgecrimpt; gemäß DIN 46228, Teil 4/09.90	<a href="http://www.wago.com/216-266">www.wago.com/216-266</a>
--	---	--

	<b>Art-Nr.: 216-267</b> Aderendhülse; Hülse für 4 mm <sup>2</sup> / AWG 12; mit Kunststoffkragen; galvanisch verzinkt; Elektrolytkupfer; gasdicht aufgecrimpt; gemäß DIN 46228, Teil 4/09.90	<a href="http://www.wago.com/216-267">www.wago.com/216-267</a>
--	---	--

#### Prüfen und Messen





	<b>Art-Nr.: 2006-511</b> Modularer TOPJOB®S-Steckverbinder; anreihbar; für Brückerschlitze; 1-polig	<a href="http://www.wago.com/2006-511">www.wago.com/2006-511</a>
--	--	--

	<b>Art-Nr.: 2006-549</b> Blindmodul; anreihbar; zum Überspringen von z. B. gebrückten Klemmen	<a href="http://www.wago.com/2006-549">www.wago.com/2006-549</a>
	<b>Art-Nr.: 2009-174</b> Prüfadapter; für Prüfstecker Ø 4 mm; zur Prüfung von TOPJOB®S-Reihenklemmen	<a href="http://www.wago.com/2009-174">www.wago.com/2009-174</a>
	<b>Art-Nr.: 2009-182</b> Prüfabgriff; für max. 2,5 mm <sup>2</sup> ; für den werkzeuglosen Anschluss individueller Prüfleitungen von 0,08 mm - 2,5 mm	<a href="http://www.wago.com/2009-182">www.wago.com/2009-182</a>
	<b>Art-Nr.: 210-136</b> Prüfstecker; Ø 2 mm; mit 500mm-Leitung	<a href="http://www.wago.com/210-136">www.wago.com/210-136</a>

#### Abschlussplatte

	<b>Art-Nr.: 2106-1291</b> Abschluss- und Zwischenplatte; 1 mm dick	<a href="http://www.wago.com/2106-1291">www.wago.com/2106-1291</a>
	<b>Art-Nr.: 2106-1292</b> Abschluss- und Zwischenplatte; 1 mm dick	<a href="http://www.wago.com/2106-1292">www.wago.com/2106-1292</a>

#### Tragschiene

	<b>Art-Nr.: 210-112</b> Stahltragschiene; 35 x 7,5 mm; 1 mm dick; 2 m lang; gelocht; entsprechend EN 60715; Lochbreite 25 mm; Lochabstand 36 mm	<a href="http://www.wago.com/210-112">www.wago.com/210-112</a>
	<b>Art-Nr.: 210-113</b> Stahltragschiene; 35 x 7,5 mm; 1 mm dick; 2 m lang; ungelocht; entsprechend EN 60715	<a href="http://www.wago.com/210-113">www.wago.com/210-113</a>
	<b>Art-Nr.: 210-114</b> Stahltragschiene; 35 x 15 mm; 1,5 mm dick; 2 m lang; ungelocht; ähnlich EN 60715	<a href="http://www.wago.com/210-114">www.wago.com/210-114</a>
	<b>Art-Nr.: 210-115</b> Stahltragschiene; 35 x 7,5 mm; 1 mm dick; 2 m lang; gelocht; entsprechend EN 60715; Lochbreite 18 mm; Lochabstand 25 mm	<a href="http://www.wago.com/210-115">www.wago.com/210-115</a>
	<b>Art-Nr.: 210-118</b> Stahltragschiene; 35 x 15 mm; 2,3 mm dick; 2 m lang; ungelocht; entsprechend EN 60715	<a href="http://www.wago.com/210-118">www.wago.com/210-118</a>
	<b>Art-Nr.: 210-196</b> Aluminiumtragschiene; 35 x 8,2 mm; 1,6 mm dick; 2 m lang; ungelocht; ähnlich EN 60715	<a href="http://www.wago.com/210-196">www.wago.com/210-196</a>
	<b>Art-Nr.: 210-197</b> Stahltragschiene; 35 x 15 mm; 1,5 mm dick; 2 m lang; gelocht; ähnlich EN 60715	<a href="http://www.wago.com/210-197">www.wago.com/210-197</a>
	<b>Art-Nr.: 210-198</b> Kupfertragschiene; 35 x 15 mm; 2,3 mm dick; 2 m lang; ungelocht; entsprechend EN 60715	<a href="http://www.wago.com/210-198">www.wago.com/210-198</a>

#### Downloads

##### Dokumentation

##### Ausschreibungstext

2106-5201	Aug 15, 2018	DOCX 15,0 kB	Download
-----------	--------------	-----------------	----------





## smartDATA

### CAD Daten

3D Download 2106-5201

URL

Download

---

## Produktfamilie

### TOPJOB S

TOPJOB® S: Das breite und flexible Produktprogramm an Reihenklemmen bietet in diversen Industrieanwendungen und in der modernen Gebäudeinstallation mehr als nur eine sichere elektrische Verbindung.

[Mehr über die Produktfamilie erfahren](#)

[Alle Produkte der Familie anzeigen](#)

Änderungen vorbehalten.

---

WAGO Kontakttechnik GmbH & Co. KG  
Hansastr. 27  
32423 Minden  
Telefon: +49571 887-0  
E-Mail: [info.de@wago.com](mailto:info.de@wago.com) | Web: [www.wago.com](http://www.wago.com)

Haben Sie Fragen zu unseren Produkten?  
Wir stehen Ihnen telefonisch unter +49 (571) 887-44222 gern zur  
Verfügung.