













KEGEL- UND ENTGRATSENKER

FASCINATION  PRECISION®

Artikel- und Anwendungsübersicht:













Werkstoff	Oberfläche	DIN	Form	Senkwinkel	Schneiden	Schaft	Ø mm	Art. Nr.	Sonstiges	Seite
HSS		DIN 335	C	90°			6,3 - 31,0 mm	102 767 - 102 785		112 - 115
HSS	RUNa TEC	DIN 335	C	90°			6,3 - 31,0 mm	102 767 P - 102 785 P		112 - 115
HSSE Co 5		DIN 335	C	90°			6,3 - 31,0 mm	102 767 E - 102 785 E		112 - 115
HSSE Co 5	RUNa TEC	DIN 335	C	90°			6,3 - 31,0 mm	102 767 EP - 102 785 EP		112 - 115
HSS		DIN 335	C	90°			4,3 - 40,0 mm	102 101 - 102 174		116 - 118
HSS		DIN 335	C	90°			6,3 - 31,0 mm	102 107 A - 102 125 A	AL	116 - 118
HSSE Co 5		DIN 335	C	90°			4,3 - 31,0 mm	102 101 E - 102 125 E		116 - 118
HSS	TiN	DIN 335	C	90°			4,3 - 40,0 mm	102 101 T - 102 174 T		116 - 118
HSS	TiAlN	DIN 335	C	90°			4,3 - 40,0 mm	102 101 F - 102 174 F		116 - 118
TC		DIN 335	C	90°			6,3 - 31,0 mm	102 261 - 102 268		116 - 118
ASP		DIN 335	C	90°			6,3 - 31,0 mm	102 107 ASP - 102 125 ASP		119
HSS		DIN 335	C	90°			6,3 - 25,0 mm	102 271 - 102 288		120
HSS		DIN 335	D	90°			15,0 - 80,0 mm	102 126 - 102 141		121
HSS		DIN 335	C	82°			1/4" - 1"	102 182 - 102 191	Inch	122
HSS		DIN 334	C	60°			6,3 - 25,0 mm	102 201 - 102 207		123
HSS		DIN 334	D	60°			16,0 - 80,0 mm	102 208 - 102 215		123
HSS			C	75°			6,3 - 25,0 mm	102 221 - 102 227		124
HSS			D	75°			16,5 - 40,0 mm	102 228 - 102 232		124

Stahl (N/mm ²) < 900	Stahl (N/mm ²) < 1100	Stahl (N/mm ²) < 1300	rostfreier Stahl	Aluminium	Messing	Bronze	Kunststoffe	Gusseisen	Titan legiert
									
■			□	■	■	□	■	□	
■	□		■	■	■	□	■	□	
■	■	□	■	■	■	□	■	□	
■	■	■	■	■	■	□	■	□	□
■				■	■	□	■	□	
□				■	□		■		
■	■		■	■	■	□	■	□	
■	□		□		■	□	■	□	
■	■		■	■	■	□	■	□	
■	■	■	■	■	□	■	■	■	■
■				■	■	□	■	□	
■				■	■	□	■	□	
■				■	■	□	■	□	
■	■		■	■	■	□	■	■	□
■				■	■	□	■	□	
■				■	■	□	■	□	
■				■	■	□	■	□	
■				■	■	□	■	□	
■				■	■	□	■	□	

Artikel- und Anwendungsübersicht:



Werkstoff	Oberfläche	DIN	Form	Senkwinkel	Schneiden	Schaft	Ø mm	Art. Nr.	Sonstiges	Seite
HSS			C	120°			6,3 - 25,0 mm	102 241 - 102 247		125
HSS			D	120°			16,5 - 40,0 mm	102 248 - 102 252		125
HSS			C	90°			6,0 - 50,0 mm	102 521 - 102 530		126
HSS							2/5 - 20/25	102 301 - 102 305		127
HSSE Co 5							1/4 - 20/25	102 300 E - 102 305 E		127
HSS	TiN						2/5 - 20/25	102 301 T - 102 305 T		127
HSS				90°			6,3 - 20,5 mm	W102 313 - W102 318		128
HSS	TiN			90°			6,3 - 20,5 mm	W102 313T - W102 318T		128
HSS				90°			6,3 - 20,5 mm	102 313 - 102 318		129
HSS	TiN			90°			6,3 - 20,5 mm	102 313T - 102 318T		129
HSS				180°			M3 - M12	102 401 - 102 421		130 - 131
HSS	TiN			180°			M3 - M12	102 401 T - 102 421 T		130 - 131
HSS				180°			M10 - M22	102 422 - 102 442		132
HSS		DIN 8374 DIN 8376 DIN 8378	N				M3 - M12	102 601 - 102 619	118°	134
HSS			N				M3 - M12	102 620 - 102 638	118°	135

Stahl (N/mm ²) < 900 	Stahl (N/mm ²) < 1100 	Stahl (N/mm ²) < 1300 	rostfreier Stahl 	Aluminium 	Messing 	Bronze 	Kunststoffe 	Gusseisen 	Titan legiert 
■				■	■	□	■	□	
■				■	■	□	■	□	
■				■	■	□	■	□	
■				■	■	□	■	□	
■	■		■	■	■	□	■	□	
■	□		□		■	□	■	□	
■				■	■	□	■	□	
■	□		□		■	□	■	□	
■				■	■	□	■	□	
■	□		□		■	□	■	□	
■				■	■	□	■	□	
■	□		□		■	□	■	□	
■				■	■	□	■	□	
■				■	■	□	■	□	
■				■	■	□	■	□	

Technisch vollendet.

Der neue RUKO
ULTIMATECUT[®]
Kegelsenker

- Bis zu 30% Zeitersparnis
- Bis zu 2-mal mehr Senkungen
- Optimales, glattes Senkergesamt



OUT NOW

Informationen
und Videos

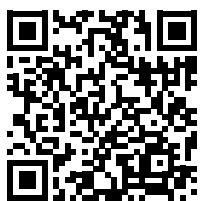

**RUna
TEC**

ULTIMATECUT®



Präziser. Schneller. Kraftvoller.

Speziell entwickelte Spanraumparameter, wie Spanwinkel, Übergangsradius sowie die extra breite Spannute sorgen für eine optimale Span- und Wärmeabfuhr und ermöglichen dadurch eine sehr hohe Verschleißfestigkeit. Zudem wirkt die neue Geometrie Materialverschweißungen entgegen und reduziert die Senkkkräfte enorm.

Der speziell entwickelte, variabel verlaufende Hinterschliff sorgt für einen sehr ruhigen Senkvorgang. Dieser erzeugt eine optimale Oberflächenqualität und garantiert dadurch beste Senkergebnisse. (Mit der neuen RUnaTEC Beschichtung kann die Qualität der Oberfläche nochmals gesteigert werden.)

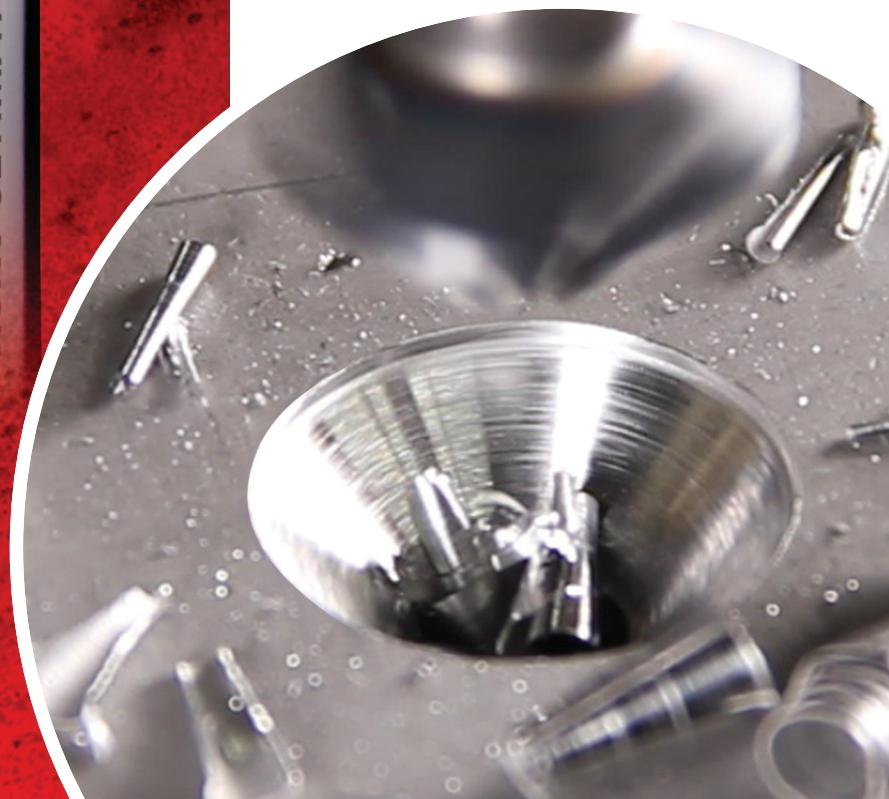



ULTIMATECUT Kegel- und Entgratsenker DIN 335 Form C 90°

Der **ULTIMATECUT** Kegelsenker ist ein Hochleistungswerkzeug das für beste Performance steht: Bis zu 30% Zeitersparnis, doppelt so viele Senkungen wie mit Standard-Senkern und ein optimales glattes Senkergesamt und das in fast allen Materialien.

Das erreicht der Kegelsenker von RUKO durch seine einzigartige Schneidengeometrie, mit dem speziell entwickelten variablen Hinterschliff, Übergangsradien und der extra breiten Spannutt.



Verpackungseinheit: einzeln in Kunststoffverpackung

- erreicht beste Performance in fast allen Materialien und Anwendungen
- deutlich weniger Vorschubkraft erforderlich
- bis zu 60% höhere Standzeiten
- bis zu 30% schnelleres Senken
- extrem ruhiger Lauf
- optimales Senkbild
- ideale Spanabfuhr

Stahl (N/mm ²) < 900	■	■	■	■
Stahl (N/mm ²) < 1100		□	■	■
Stahl (N/mm ²) < 1300			□	■
rostfreier Stahl	□	■	■	■
Aluminium	■	■	■	■

Messing	■	■	■	■
Bronze	□	□	□	□
Kunststoffe	■	■	■	■
Gusseisen	□	□	□	□
Titan legiert				□

Ø2 mm	Ø1 mm	L1 mm	Ø3 mm	Senkungen nach DIN 74 / BF	HSS	HSS RUna TEC	HSSE Co 5	HSSE Co 5 RUna TEC	
6,3	1,5	45,0	5,0	M 3	102 767	102 767 P	102 767 E	102 767 EP	1
8,3	2,0	50,0	6,0	M 4	102 771	102 771 P	102 771 E	102 771 EP	1
10,4	2,5	50,0	6,0	M 5	102 774	102 774 P	102 774 E	102 774 EP	1
12,4	2,8	56,0	8,0	M 6	102 776	102 776 P	102 776 E	102 776 EP	1
15,0	3,2	60,0	10,0	M 8	102 778	102 778 P	102 778 E	102 778 EP	1
16,5	3,2	60,0	10,0	M 8	102 779	102 779 P	102 779 E	102 779 EP	1
19,0	3,5	63,0	10,0	M 10	102 780	102 780 P	102 780 E	102 780 EP	1
20,5	3,5	63,0	10,0	M 10	102 781	102 781 P	102 781 E	102 781 EP	1
23,0	3,8	67,0	10,0	M 12	102 782	102 782 P	102 782 E	102 782 EP	1
25,0	3,8	67,0	10,0	M 12	102 783	102 783 P	102 783 E	102 783 EP	1
31,0	4,2	71,0	12,0	M 16	102 785	102 785 P	102 785 E	102 785 EP	1





ULTIMATECUT Kegel- und Entgratsenker-Sätze HSS DIN 335 Form C 90° in ABS-Kunststoffkassette

	HSS	RUna TEC
6-teiliger ULTIMATECUT Kegel- und Entgratsenker-Satz HSS (DIN 335) Form C 90° Ø 6,3 - 8,3 - 10,4 - 12,4 - 16,5 - 20,5 mm	102 790 RO	102 790 PRO
5-teiliger ULTIMATECUT Kegel- und Entgratsenker-Satz HSS (DIN 335) Form C 90° Ø 6,3 - 10,4 - 16,5 - 20,5 - 25,0 mm	102 791 RO	102 791 PRO



ULTIMATECUT Kegel- und Entgratsenker-Sätze HSSE-Co 5 DIN 335 Form C 90° in ABS-Kunststoffkassette

	HSSE Co 5	RUna TEC
6-teiliger ULTIMATECUT Kegel- und Entgratsenker-Satz HSSE-Co 5 (DIN 335) Form C 90° Ø 6,3 - 8,3 - 10,4 - 12,4 - 16,5 - 20,5 mm	102 790 ERO	102 790 EPRO
5-teiliger ULTIMATECUT Kegel- und Entgratsenker-Satz HSSE-Co 5 (DIN 335) Form C 90° Ø 6,3 - 10,4 - 16,5 - 20,5 - 25,0 mm	102 791 ERO	102 791 EPRO







Kegel- und Entgratsenker DIN 335 Form C 90°

Durch die CBN tiefgeschliffenen Spannuten sind die Schneiden absolut scharf.
Zum grat- und ratterfreien Ansenken, Entgraten und Versenken.
Beste Ergebnisse bei niedriger Schnittgeschwindigkeit.

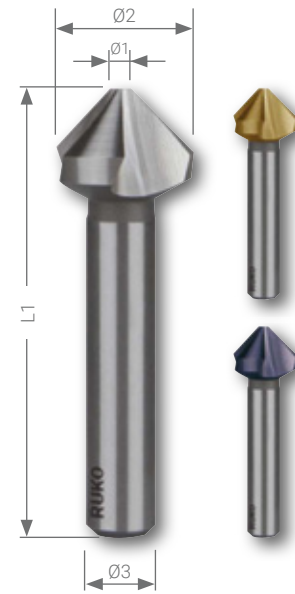
Verpackungseinheit: einzeln in Kunststoffverpackung



 Um die Standzeit zu erhöhen - Drehzahl reduzieren!
Kühlen beim Senken!

Stahl (N/mm2) < 900	■	□	■	■	■	■
Stahl (N/mm2) < 1100			■	□	■	■
Stahl (N/mm2) < 1300						■
rostfreier Stahl			■	□	■	■
Aluminium	■	■	■		■	■

Messing	■	□	■	■	■	□
Bronze	□		□	□	□	■
Kunststoffe	■	■	■	■	■	■
Gusseisen	□		□	□	□	■
Titan legiert						

Ø2 mm	Ø1 mm	L1 mm	Ø3 mm	Senkungen nach DIN 74								
				AF	BF							
4,3	1,3	40,0	4,0			102 101	—	102 101 E	102 101 T	102 101 F	—	1
4,8	1,5	40,0	4,0			102 102	—	—	102 102 T	102 102 F	—	1
5,0	1,5	40,0	4,0	M 2,5		102 103	—	102 103 E	102 103 T	102 103 F	—	1
5,3	1,5	40,0	4,0			102 104	—	102 104 E	102 104 T	102 104 F	—	1
5,8	1,5	45,0	5,0			102 105	—	—	102 105 T	102 105 F	—	1
6,0	1,5	45,0	5,0	M 3		102 106	—	102 106 E	102 106 T	102 106 F	—	1
6,3	1,5	45,0	5,0		M 3	102 107	102 107 A	102 107 E	102 107 T	102 107 F	102 261	1
7,0	1,8	50,0	6,0	M 3,5		102 108	—	—	102 108 T	102 108 F	—	1
7,3	1,8	50,0	6,0			102 109	—	—	102 109 T	102 109 F	—	1
8,0	2,0	50,0	6,0	M 4		102 110	—	102 110 E	102 110 T	102 110 F	—	1
8,3	2,0	50,0	6,0		M 4	102 111	102 111 A	102 111 E	102 111 T	102 111 F	102 262	1
9,4	2,2	50,0	6,0			102 112	—	—	102 112 T	102 112 F	—	1
10,0	2,5	50,0	6,0	M 5		102 113	—	102 113 E	102 113 T	102 113 F	—	1
10,4	2,5	50,0	6,0		M 5	102 114	102 114 A	102 114 E	102 114 T	102 114 F	102 263	1
11,5	2,8	56,0	8,0	M 6		102 115	—	102 115 E	102 115 T	102 115 F	—	1
12,4	2,8	56,0	8,0		M 6	102 116	102 116 A	102 116 E	102 116 T	102 116 F	102 264	1
13,4	2,9	56,0	8,0			102 117	—	—	102 117 T	102 117 F	—	1
15,0	3,2	60,0	10,0	M 8		102 118	—	102 118 E	102 118 T	102 118 F	—	1
16,5	3,2	60,0	8,0		M 8	102 119	102 119 A	102 119 E	102 119 T	102 119 F	—	1
16,5	3,2	60,0	10,0		M 8	102 119-1	102 119-1 A	102 119-1 E	102 119-1 T	102 119-1 F	102 265	1
19,0	3,5	63,0	10,0	M 10		102 120	—	102 120 E	102 120 T	102 120 F	—	1
20,5	3,5	63,0	10,0		M 10	102 121	102 121 A	102 121 E	102 121 T	102 121 F	102 266	1
23,0	3,8	67,0	10,0	M 12		102 122	—	102 122 E	102 122 T	102 122 F	—	1
25,0	3,8	67,0	10,0		M 12	102 123	102 123 A	102 123 E	102 123 T	102 123 F	102 267	1
26,0	3,9	71,0	12,0	M 14		102 171	—	—	102 171 T	102 171 F	—	1
28,0	4,0	71,0	12,0		M 14	102 124	—	102 124 E	102 124 T	102 124 F	—	1
30,0	4,1	71,0	12,0	M 16		102 172	—	—	102 172 T	102 172 F	—	1
31,0	4,2	71,0	12,0		M 16	102 125	102 125 A	102 125 E	102 125 T	102 125 F	102 268	1
37,0	4,8	90,0	12,0			102 173	—	—	102 173 T	102 173 F	—	1
40,0	10,0	80,0	15,0			102 174	—	—	102 174 T	102 174 F	—	1



Kegel- und Entgratsenker-Sätze DIN 335 Form C 90° HSS, HSSE-Co 5 und Hartmetall K 20 in Industriekassette

	HSS	HSS für / for ALU	HSSE Co 5	HSS TIN	HSS TiAIN	TC
5-teiliger Kegel- und Entgratsenker-Satz DIN 335 Form C 90° Ø 6,3 - 10,4 - 16,5 - 20,5 - 25,0 mm	102 154	102 154 A	102 154 E	102 154 T	102 154 F	—
6-teiliger Kegel- und Entgratsenker-Satz DIN 335 Form C 90° Ø 6,3 - 8,3 - 10,4 - 12,4 - 16,5 - 20,5 mm	102 152	102 152 A	102 152 E	102 152 T	102 152 F	102 152 HM



102 154



102 154 T



102 154 F



102 152



102 152 T



102 152 F

Kegel- und Entgratsenker-Satz DIN 335 Form C 90° HSS in Holzkassette

	HSS
17-teiliger Kegel- und Entgratsenker-Satz DIN 335 Form C 90° Ø 4,3 - 5,0 - 6,0 - 6,3 - 7,0 - 8,0 - 8,3 - 10,0 - 10,4 - 11,5 - 12,4 - 15,0 - 16,5 - 19,0 - 20,5 - 23,0 - 25,0 mm (Ø 16,5 mm = Schaft-Ø 10,0 mm) in Holzkassette	102 155



102 155



Kegel- und Entgratsenker-Sätze DIN 335 Form C 90° HSS, HSSE-Co 5 und Hartmetall K 20 in ABS-Kunststoffkassette

	HSS	HSS für ALU	HSSE Co 5	HSS TIN	HSS TiAIN	TC
5-teiliger Kegel- und Entgratsenker-Satz DIN 335 Form C 90° Ø 6,3 - 10,4 - 16,5 - 20,5 - 25,0 mm	102 154 RO	–	102 154 ERO	102 154 TRO	102 154 FRO	–
6-teiliger Kegel- und Entgratsenker-Satz DIN 335 Form C 90° Ø 6,3 - 8,3 - 10,4 - 12,4 - 16,5 - 20,5 mm	102 152 RO	–	102 152 ERO	102 152 TRO	102 152 FRO	102 152 HMRO
17-teiliger Kegel- und Entgratsenker-Satz DIN 335 Form C 90° Ø 4,3 - 5,0 - 6,0 - 6,3 - 7,0 - 8,0 - 8,3 - 10,0 - 10,4 - 11,5 - 12,4 - 15,0 - 16,5 - 19,0 - 20,5 - 23,0 - 25,0 mm (Ø 16,5 mm = Schaft-Ø 10,0 mm)	102 155 RO	–	–	–	–	–
6-teiliger Kegel- und Entgratsenker-Satz DIN 335 Form C 90° Ø 6,3 - 10,4 - 16,5 - 20,5 - 25,0 mm + 1 Schneidpaste 50 ml	102 142	102 142 A	102 142 E	102 142 T	–	–



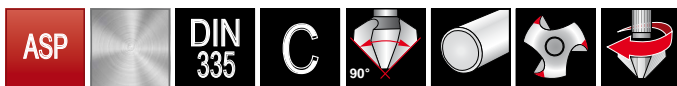

Kegel- und Entgratsenker DIN 335 Form C 90° ASP

Der Kegel- und Entgratsenker DIN 335 Form C 90° ASP wird aus pulvermetallurgischem Metall gefertigt und besitzt dadurch eine höhere Schneidkantenstabilität. Beste Ergebnisse in VA Stählen, Hardox 400 Stählen, Titan- und Titanlegierungen.

Verpackungseinheit: einzeln in Kunststoffverpackung

Stahl (N/mm ²) < 900	■	Messing	■
Stahl (N/mm ²) < 1100	■	Bronze	□
Stahl (N/mm ²) < 1300		Kunststoffe	■
rostfreier Stahl	■	Gusseisen	■
Aluminium	■	Titan legiert	□

Ø2 mm	Ø1 mm	L1 mm	Ø3 mm	Senkungen nach DIN 74 / BF		
6,3	1,5	45,0	5,0	M 3	102 107 ASP	1
8,3	2,0	50,0	6,0	M 4	102 111 ASP	1
10,4	2,5	50,0	6,0	M 5	102 114 ASP	1
12,4	2,8	56,0	8,0	M 6	102 116 ASP	1
16,5	3,2	60,0	10,0	M 8	102 119-1 ASP	1
20,5	3,5	63,0	10,0	M 10	102 121 ASP	1
25,0	3,8	67,0	10,0	M 12	102 123 ASP	1
31,0	4,2	71,0	12,0	M 16	102 125 ASP	1

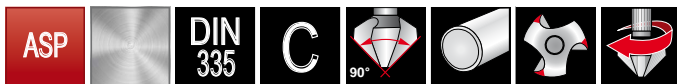

Kegel- und Entgratsenker-Sätze DIN 335 Form C 90° ASP in Industriekassette

6-teiliger Kegel- und Entgratsenker-Satz DIN 335 Form C 90° ASP Ø 6,3 - 8,3 - 10,4 - 12,4 - 16,5 - 20,5 mm	102 152 ASP
5-teiliger Kegel- und Entgratsenker-Satz DIN 335 Form C 90° ASP Ø 6,3 - 10,4 - 16,5 - 20,5 - 25,0 mm	102 154 ASP



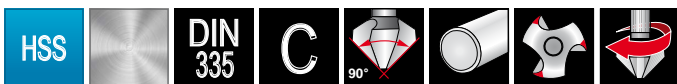

Kegel- und Entgratsenker DIN 335 Form C 90° HSS, mit langem Zylinderschaft

Durch die CBN-tiefgeschliffenen Spannuten sind die Schneiden absolut scharf.
Zum grat- und ratterfreien Ansenken, Entgraten und Versenken.
Beste Ergebnisse bei niedriger Schnittgeschwindigkeit.

Verpackungseinheit: einzeln in Kunststoffverpackung

Stahl (N/mm ²) < 900	■	Messing	■
Stahl (N/mm ²) < 1100		Bronze	□
Stahl (N/mm ²) < 1300		Kunststoffe	■
rostfreier Stahl		Gusseisen	□
Aluminium	■	Titan legiert	

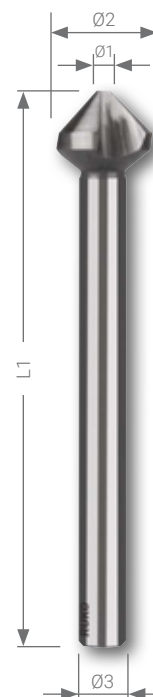

Ø2 mm	Ø1 mm	L1 mm	Ø3 mm	Senkungen nach DIN 74		HSS	
				AF	BF		
6,3	1,5	85,0	5,0	-	M 3	102 271	1
8,3	2,0	85,0	6,0	-	M 4	102 272	1
10,4	2,5	88,0	6,0	-	M 5	102 273	1
12,4	2,8	108,0	8,0	-	M 6	102 274	1
15,0	3,2	110,0	10,0	M 8	-	102 275	1
16,5	3,2	112,0	10,0	-	M 8	102 276	1
20,5	3,5	115,0	10,0	-	M 10	102 277	1
25,0	3,8	118,0	10,0	-	M 12	102 278	1

Ø2 mm	Ø1 mm	L1 mm	Ø3 mm	Senkungen nach DIN 74		HSS	
				AF	BF		
6,3	1,5	154,0	5,0	-	M 3	102 281	1
8,3	2,0	155,0	6,0	-	M 4	102 282	1
10,4	2,5	157,0	6,0	-	M 5	102 283	1
12,4	2,8	158,0	8,0	-	M 6	102 284	1
15,0	3,2	158,0	10,0	M 8	-	102 285	1
16,5	3,2	161,0	10,0	-	M 8	102 286	1
20,5	3,5	164,0	10,0	-	M 10	102 287	1
25,0	3,8	164,0	10,0	-	M 12	102 288	1



Kegel- und Entgratsenker DIN 335 Form C 90° HSS, mit langem Zylinderschaft in ABS-Kunststoffkassette

6-teiliger Kegel- und Entgratsenker-Satz DIN 335 Form C 90° Ø 6,3 - 8,3 - 10,4 - 12,4 - 16,5 - 20,5 mm	102 158 RO





Kegel- und Entgratsenker DIN 335 Form D 90° HSS

Verpackungseinheit: einzeln in Kunststoffverpackung

	<input checked="" type="checkbox"/>		<input checked="" type="checkbox"/>
Stahl (N/mm2) < 900	<input checked="" type="checkbox"/>	Messing	<input checked="" type="checkbox"/>
Stahl (N/mm2) < 1100	<input type="checkbox"/>	Bronze	<input type="checkbox"/>
Stahl (N/mm2) < 1300	<input type="checkbox"/>	Kunststoffe	<input checked="" type="checkbox"/>
rostfreier Stahl	<input type="checkbox"/>	Gusseisen	<input type="checkbox"/>
Aluminium	<input checked="" type="checkbox"/>	Titan legiert	<input type="checkbox"/>

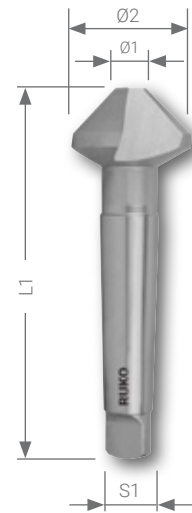

Ø2 mm	Ø1 mm	L1 mm	Schaft S1	Senkungen nach DIN 74		HSS		
				AF	BF			
15,0	3,2	85,0	MK 1	M 8	-	102 126		1
16,5	3,2	85,0	MK 1	-	M 8	102 127		1
19,0	3,5	100,0	MK 2	M 10	-	102 128		1
20,5	3,5	100,0	MK 2	-	M 10	102 129		1
23,0	3,8	106,0	MK 2	M 12	-	102 130		1
25,0	3,8	106,0	MK 2	-	M 12	102 131		1
26,0	3,8	106,0	MK 2	M 14	-	102 132		1
28,0	4,0	112,0	MK 2	-	M 14	102 133		1
30,0	4,2	112,0	MK 2	M 16	-	102 134		1
31,0	4,2	112,0	MK 2	-	M 16	102 135		1
34,0	4,5	118,0	MK 2	M 18	M 18	102 136		1
37,0	4,8	118,0	MK 2	M 20	M 20	102 137		1
40,0	10,0	140,0	MK 3	-	-	102 138		1
50,0	14,0	150,0	MK 3	-	-	102 139		1
63,0	16,0	180,0	MK 4	-	-	102 140		1
80,0	22,0	190,0	MK 4	-	-	102 141		1



Handentgrater DIN 335 Form C 90° HSS, CBN-geschliffen

Verpackungseinheit: einzeln in Kunststoffverpackung

	<input checked="" type="checkbox"/>		
Handentgrater mit Senker Ø 12,4 mm	102 143	1	
Handentgrater mit Senker Ø 15,0 mm	102 144	1	
Handentgrater mit Senker Ø 16,5 mm	102 145	1	
Handentgrater mit Senker Ø 20,5 mm	102 146	1	
Handentgrater mit Senker Ø 25,0 mm	102 147	1	



Universalhandgriffe zur Aufnahme von Senkwerkzeugen

Verpackungseinheit: einzeln in Kunststoffverpackung

	<input checked="" type="checkbox"/>		
Universalhandgriff für Senker mit 8,0 mm Schaft-Ø	102 148	1	
Universalhandgriff für Senker mit 10,0 mm Schaft-Ø	102 149	1	
Universalhandgriff für Senker mit 1/4" Sechskantschaft	102 320	1	



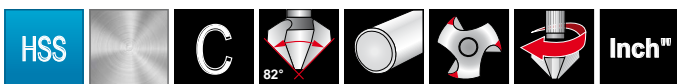

Kegel- und Entgratsenker Form C 82° HSS in Zollabmessungen

Verpackungseinheit: einzeln in Kunststoffverpackung

Stahl (N/mm ²) < 900	■	Messing	■
Stahl (N/mm ²) < 1100		Bronze	□
Stahl (N/mm ²) < 1300		Kunststoffe	■
rostfreier Stahl		Gusseisen	□
Aluminium	■	Titan legiert	

Ø2		Ø1		Ø3		L1		HSS		
inch	mm	inch	inch	mm	inch	mm				
1/4	6,4	3/64	3/16	5,0	1 3/4	45,0	102 182			1
5/16	7,9	4/64	1/4	6,0	2"	50,0	102 183			1
3/8	9,5	5/64	1/4	6,0	2"	50,0	102 184			1
1/2	12,7	6/64	5/16	8,0	2 3/16	56,0	102 186			1
5/8	15,9	7/64	3/8	10,0	2 3/8	60,0	102 188			1
3/4	19,1	8/64	3/8	10,0	2 1/2	63,0	102 189			1
7/8	22,2	9/64	3/8	10,0	2 5/8	67,0	102 190			1
1	25,4	9/64	3/8	10,0	2 5/8	76,0	102 191			1

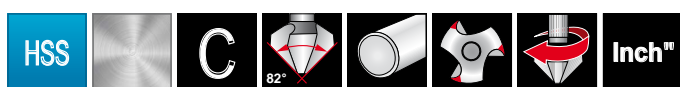

Kegel- und Entgratsenker Satz Form C 82° HSS in Zollabmessungen, in ABS-Kunststoffkassette

		HSS	
5-teiliger Kegel- und Entgratsenker-Satz Form C 82° HSS Ø 1/4 - 3/8 - 1/2 - 3/4 - 1 inch		102 193 RO	



Kühl- und Schmierstoffe

Die RUKO Kühl- und Schmierstoffe zeigen eine hervorragende Trenn- und Kühlwirkung. Sie erzeugen eine hohe Oberflächengüte und erhöhen die Werkzeugstandzeiten auch bei harten und spröden Materialien.

Passend auf unser Sortiment abgestimmt finden Sie die neue Kühl- und Schmierstoffserie in unserem neuen Kapitel 14 ab der Seite 289.



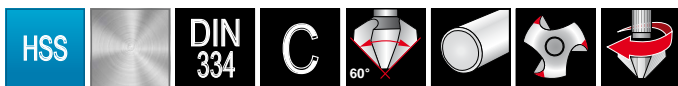

Kegel- und Entgratsenker DIN 334 Form C 60° HSS

Verpackungseinheit: einzeln in Kunststoffverpackung

Stahl (N/mm ²) < 900	■	Messing	■
Stahl (N/mm ²) < 1100		Bronze	□
Stahl (N/mm ²) < 1300		Kunststoffe	■
rostfreier Stahl		Gusseisen	□
Aluminium	■	Titan legiert	

Ø2 mm	Ø1 mm	L1 mm	Ø3 mm	HSS		
6,3	1,6	45,0	5,0	102 201		1
8,0	2,0	50,0	6,0	102 202		1
10,0	2,5	50,0	6,0	102 203		1
12,5	3,2	56,0	8,0	102 204		1
16,0	4,0	63,0	10,0	102 205		1
20,0	5,0	67,0	10,0	102 206		1
25,0	6,3	71,0	10,0	102 207		1

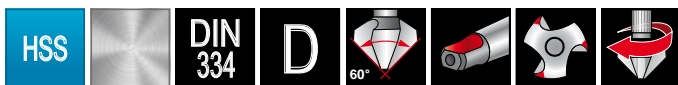
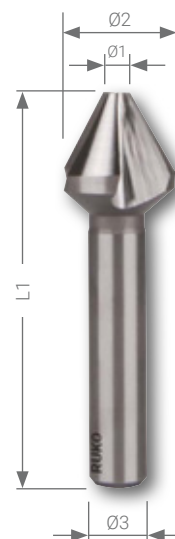

Kegel- und Entgratsenker DIN 334 Form D 60° HSS

Verpackungseinheit: einzeln in Kunststoffverpackung

Stahl (N/mm ²) < 900	■	Messing	■
Stahl (N/mm ²) < 1100		Bronze	□
Stahl (N/mm ²) < 1300		Kunststoffe	■
rostfreier Stahl		Gusseisen	□
Aluminium	■	Titan legiert	

Ø2 mm	Ø1 mm	L1 mm	Schaft S1	HSS		
16,0	4,0	90,0	MK 1	102 208		1
20,0	5,0	106,0	MK 2	102 209		1
25,0	6,3	112,0	MK 2	102 210		1
31,5	10,0	118,0	MK 2	102 211		1
40,0	12,5	150,0	MK 3	102 212		1
50,0	16,0	160,0	MK 3	102 213		1
63,0	20,0	190,0	MK 4	102 214		1
80,0	25,0	200,0	MK 4	102 215		1

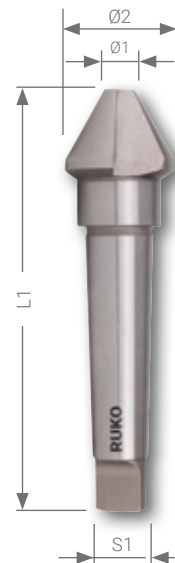

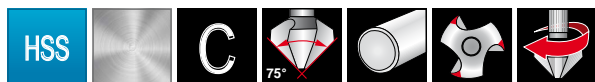

Kegel- und Entgratsenker Form C 75° HSS

Verpackungseinheit: einzeln in Kunststoffverpackung

Stahl (N/mm ²) < 900	<input checked="" type="checkbox"/>	Messing	<input checked="" type="checkbox"/>
Stahl (N/mm ²) < 1100	<input type="checkbox"/>	Bronze	<input type="checkbox"/>
Stahl (N/mm ²) < 1300	<input type="checkbox"/>	Kunststoffe	<input checked="" type="checkbox"/>
rostfreier Stahl	<input type="checkbox"/>	Gusseisen	<input type="checkbox"/>
Aluminium	<input checked="" type="checkbox"/>	Titan legiert	<input type="checkbox"/>

Ø2 mm	Ø1 mm	L1 mm	Ø3 mm	HSS		
6,3	1,6	45,0	5,0	102 221		1
8,3	2,0	50,0	6,0	102 222		1
10,4	2,5	50,0	6,0	102 223		1
12,4	3,2	56,0	8,0	102 224		1
16,5	4,0	63,0	10,0	102 225		1
20,5	5,0	67,0	10,0	102 226		1
25,0	6,3	71,0	10,0	102 227		1

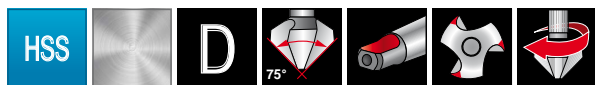
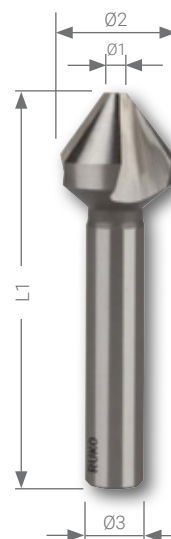

Kegel- und Entgratsenker Form D 75° HSS

Verpackungseinheit: einzeln in Kunststoffverpackung

Stahl (N/mm ²) < 900	<input checked="" type="checkbox"/>	Messing	<input checked="" type="checkbox"/>
Stahl (N/mm ²) < 1100	<input type="checkbox"/>	Bronze	<input type="checkbox"/>
Stahl (N/mm ²) < 1300	<input type="checkbox"/>	Kunststoffe	<input checked="" type="checkbox"/>
rostfreier Stahl	<input type="checkbox"/>	Gusseisen	<input type="checkbox"/>
Aluminium	<input checked="" type="checkbox"/>	Titan legiert	<input type="checkbox"/>

Ø2 mm	Ø1 mm	L1 mm	Schaft S1	HSS		
16,5	3,5	87,0	MK 1	102 228		1
20,5	4,5	102,0	MK 2	102 229		1
25,0	5,0	109,0	MK 2	102 230		1
31,0	5,0	116,0	MK 2	102 231		1
40,0	10,0	145,0	MK 3	102 232		1





Kegel- und Entgratsenker Form C 120° HSS

Verpackungseinheit: einzeln in Kunststoffverpackung

Stahl (N/mm ²) < 900	<input checked="" type="checkbox"/>	Messing	<input checked="" type="checkbox"/>
Stahl (N/mm ²) < 1100	<input type="checkbox"/>	Bronze	<input type="checkbox"/>
Stahl (N/mm ²) < 1300	<input type="checkbox"/>	Kunststoffe	<input checked="" type="checkbox"/>
rostfreier Stahl	<input type="checkbox"/>	Gusseisen	<input type="checkbox"/>
Aluminium	<input checked="" type="checkbox"/>	Titan legiert	<input type="checkbox"/>

Ø2 mm	Ø1 mm	L1 mm	Ø3 mm	HSS		
6,3	1,5	45,0	5,0	102 241		1
8,3	2,0	50,0	6,0	102 242		1
10,4	2,5	50,0	6,0	102 243		1
12,4	3,0	56,0	8,0	102 244		1
16,5	3,5	63,0	10,0	102 245		1
20,5	4,0	67,0	10,0	102 246		1
25,0	5,0	71,0	10,0	102 247		1



Kegel- und Entgratsenker Form D 120° HSS

Verpackungseinheit: einzeln in Kunststoffverpackung

Stahl (N/mm ²) < 900	<input checked="" type="checkbox"/>	Messing	<input checked="" type="checkbox"/>
Stahl (N/mm ²) < 1100	<input type="checkbox"/>	Bronze	<input type="checkbox"/>
Stahl (N/mm ²) < 1300	<input type="checkbox"/>	Kunststoffe	<input checked="" type="checkbox"/>
rostfreier Stahl	<input type="checkbox"/>	Gusseisen	<input type="checkbox"/>
Aluminium	<input checked="" type="checkbox"/>	Titan legiert	<input type="checkbox"/>

Ø2 mm	Ø1 mm	L1 mm	Schaft S1	HSS		
16,5	3,5	87,0	MK 1	102 248		1
20,5	4,5	102,0	MK 2	102 249		1
25,0	5,0	109,0	MK 2	102 250		1
31,0	5,0	116,0	MK 2	102 251		1
40,0	10,0	145,0	MK 3	102 252		1



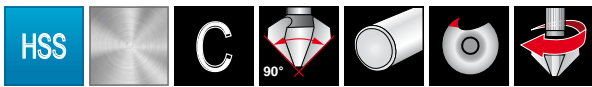

Kegel- und Entgratsenker Form C 90° HSS

Nur Ansenken und Entgraten möglich.
Senker mit einer Schneide nicht zum Vollversenken empfohlen.

Verpackungseinheit: einzeln in Kunststoffverpackung



Stahl (N/mm2) < 900	■	Messing	■
Stahl (N/mm2) < 1100		Bronze	□
Stahl (N/mm2) < 1300		Kunststoffe	■
rostfreier Stahl		Gusseisen	□
Aluminium	■	Titan legiert	

Ø2 mm	L1 mm	Ø3 mm	HSS		
6,0	45,0	5,0	102 521		1
8,0	50,0	6,0	102 522		1
10,0	50,0	6,0	102 523		1
12,0	56,0	8,0	102 524		1
16,0	60,0	10,0	102 525		1
20,0	63,0	10,0	102 526		1
25,0	67,0	10,0	102 527		1
30,0	71,0	12,0	102 528		1
40,0	89,0	15,0	102 529		1
50,0	98,0	15,0	102 530		1



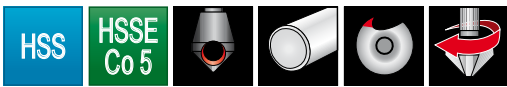

Kegel- und Entgratsenker mit Querloch 90° HSS und HSSE-Co 5

Schälender Schnitt. Der Spanablauf durch die Bohrung verhindert ein Verkleben der Späne im Werkstück. Ideal zum grat- und ratterfreien Ansenken und Entgraten bei Stahl, Guß, Bunt- und Leichtmetallen. Beste Ergebnisse bei niedriger Schnittgeschwindigkeit. Senker mit einer Schneide nicht zum Vollversenken empfehlen.

Verpackungseinheit: einzeln in Kunststoffverpackung



Stahl (N/mm2) < 900	■	■	■
Stahl (N/mm2) < 1100		■	□
Stahl (N/mm2) < 1300		□	
rostfreier Stahl		■	
Aluminium	■	■	

Messing	■	■	■
Bronze	□	□	□
Kunststoffe	■	■	■
Gusseisen	□	□	□
Titan legiert			

Größe Nr.	Ø1 mm	Ø2 mm	Ø3 mm	L1 mm					
1/4	1,0 - 4,0	6,35	6,35	45,0	—	102 300 E	—	—	1
2/5	2,0 - 5,0	10,00	6,00	45,0	102 301	102 301 E	102 301 T	—	1
5/10	5,0 - 10,0	14,00	8,00	48,0	102 302	102 302 E	102 302 T	—	1
10/15	10,0 - 15,0	21,00	10,00	65,0	102 303	102 303 E	102 303 T	—	1
15/20	15,0 - 20,0	28,00	12,00	85,0	102 304	102 304 E	102 304 T	—	1
20/25	20,0 - 25,0	35,00	12,00	102,0	102 305	102 305 E	102 305 T	—	1

Kegel- und Entgratsenker-Sätze mit Querloch 90° HSS und HSSE-Co 5

5-teiliger Kegel- und Entgratsenker-Satz mit Querloch 90° in Polystyrol-Kassette Nenn-Ø mm: 2/5 - 5/10 - 10/15 - 15/20 + 1 Dose Schneidpaste 50 g	—	102 310 E	—	—
5-teiliger Kegel- und Entgratsenker-Satz mit Querloch 90° in Industriekassette Nenn-Ø mm: 2/5 - 5/10 - 10/15 - 15/20 + 1 Dose Schneidpaste 30 g	102 312	102 312 E	102 312 T	—



Kegel- und Entgratsenker-Sätze mit Querloch 90° HSS und HSSE-Co 5 in ABS-Kunststoffkassette

4-teiliger Kegel- und Entgratsenker-Satz mit Querloch 90° in Polystyrol-Kassette Nenn-Ø mm: 2/5 - 5/10 - 10/15 - 15/20	102 312 RO	102 312 ERO	102 312 TRO	—



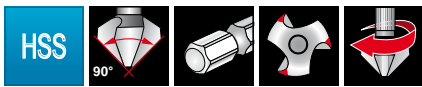

Kegel- und Entgratsenker-Bit 90° "Kurz" HSS und HSS-TiN

Schneller Werkzeugwechsel durch die Bitaufnahme. Ideal zum grat- und ratterfreien Ansenken, Entgraten und Versenken bei Stahl, Guß, Bunt- und Leichtmetallen. Beste Ergebnisse bei niedriger Schnittgeschwindigkeit.

Verpackungseinheit: einzeln in Kunststoffverpackung

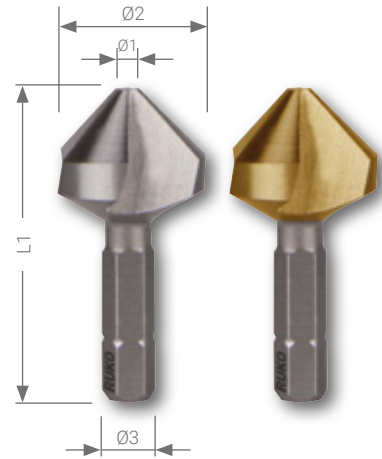

Stahl (N/mm ²) < 900	■	■	Messing	■	■
Stahl (N/mm ²) < 1100		□	Bronze	□	□
Stahl (N/mm ²) < 1300			Kunststoffe	■	■
rostfreier Stahl		□	Gusseisen	□	□
Aluminium	■		Titan legiert		

Ø2 mm	Ø1 mm	L1 mm	Ø3 inch	Senkungen nach DIN 74				
				AF	BF			
6,3	1,5	31,0	1/4"	-	M 3	W 102 313	W 102 313T	1
8,3	2,0	31,0	1/4"	-	M 4	W 102 314	W 102 314T	1
10,4	2,5	34,0	1/4"	-	M 5	W 102 315	W 102 315T	1
12,4	2,8	35,0	1/4"	-	M 6	W 102 316	W 102 316T	1
16,5	3,2	40,0	1/4"	-	M 8	W 102 317	W 102 317T	1
20,5	3,5	41,0	1/4"	-	M 10	W 102 318	W 102 318T	1

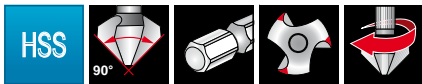

Kegel- und Entgratsenker-Bit-Satz 90° "Kurz" HSS und HSS-TiN in Industriekassette

7-teiliger Kegel- und Entgratsenker-Bit-Satz 90° "Kurz" 6 Kegel- und Entgratsenker-Bits Ø 6,3 - 8,3 - 10,4 - 12,4 - 16,5 - 20,5 mm + 1 Universalhandgriff mit 1/4" Innensechskantaufnahme	W 102 319	W 102 319 T



Sechskantmagnethalter

Verpackungseinheit: einzeln in Kunststoffverpackung

Sechskantmagnethalter	270 013	1



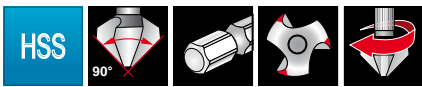

Kegel- und Entgratsenker-Bit 90° "Lang" HSS und HSS-TiN

Schneller Werkzeugwechsel durch die Bitaufnahme. Ideal zum grat- und ratterfreien Ansenken, Entgraten und Versenken bei Stahl, Guß, Bunt- und Leichtmetallen. Beste Ergebnisse bei niedriger Schnittgeschwindigkeit.

Verpackungseinheit: einzeln in Kunststoffverpackung

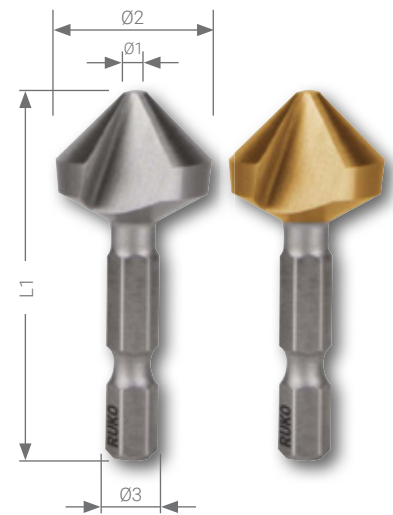

Stahl (N/mm2) < 900	■	■	Messing	■	■
Stahl (N/mm2) < 1100		□	Bronze	□	□
Stahl (N/mm2) < 1300			Kunststoffe	■	■
rostfreier Stahl		□	Gusseisen	□	□
Aluminium	■		Titan legiert		

Ø2 mm	Ø1 mm	L1 mm	Ø3 inch	Senkungen nach DIN 74				
				AF	BF			
6,3	1,5	38,0	1/4"	-	M 3	102 313	102 313 T	1
8,3	2,0	38,0	1/4"	-	M 4	102 314	102 314 T	1
10,4	2,5	41,0	1/4"	-	M 5	102 315	102 315 T	1
12,4	2,8	42,0	1/4"	-	M 6	102 316	102 316 T	1
16,5	3,2	47,0	1/4"	-	M 8	102 317	102 317 T	1
20,5	3,5	48,0	1/4"	-	M 10	102 318	102 318 T	1

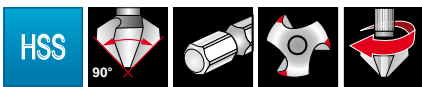

Kegel- und Entgratsenker-Bit-Satz 90° "Lang" HSS und HSS-TiN in Industriekassette

7-teiliger Kegel- und Entgratsenker-Bit-Satz 90° "Lang" 6 Kegel- und Entgratsenker-Bits Ø 6,3 - 8,3 - 10,4 - 12,4 - 16,5 - 20,5 mm + 1 Universalhandgriff mit 1/4" Innensechskantaufnahme	102 319	102 319 T



Kegel- und Entgratsenker-Bit-Satz 90° "Lang" HSS und HSS-TiN in ABS-Kunststoffkassette

8-teiliger Kegel- und Entgratsenker-Bit-Satz 90° "Lang" 6 Kegel- und Entgratsenker-Bits Ø 6,3 - 8,3 - 10,4 - 12,4 - 16,5 - 20,5 mm + 1 Universalhandgriff mit 1/4" Innensechskantaufnahme + 1 Schneidpaste 30 g	102 319 RO	102 319 TRO



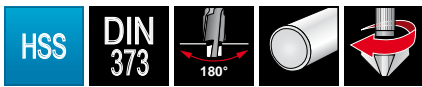

Flachsenker DIN 373 HSS mit Zylinderschaft und festem Führungzapfen

Zur Herstellung von Senkungen für Zylinderkopfschrauben, Sechskantschrauben und Muttern. Ideal zum grat- und ratterfreien Senken bei Stahl, Guß, Bunt- und Leichtmetallen. Beste Ergebnisse bei niedriger Schnittgeschwindigkeit.

Verpackungseinheit: einzeln in Kunststoffverpackung

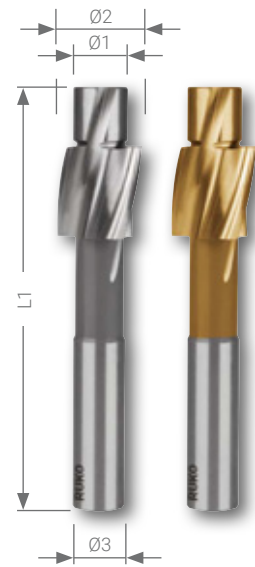

Stahl (N/mm ²) < 900	■	■	Messing	■	■
Stahl (N/mm ²) < 1100		□	Bronze	□	□
Stahl (N/mm ²) < 1300			Kunststoffe	■	■
rostfreier Stahl		□	Gusseisen	□	□
Aluminium	■		Titan legiert		

Gütegrad fein für Durchgangsloch

Für Gewinde	Ø2 mm	Ø1 mm	Ø3 mm	L1 mm			
M 3	6,0	3,2	5,0	71,0	102 401	102 401 T	1
M 4	8,0	4,3	5,0	71,0	102 402	102 402 T	1
M 5	10,0	5,3	8,0	80,0	102 403	102 403 T	1
M 6	11,0	6,4	8,0	80,0	102 404	102 404 T	1
M 8	15,0	8,4	12,5	100,0	102 405	102 405 T	1
M 10	18,0	10,5	12,5	100,0	102 406	102 406 T	1
M 12	20,0	13,0	12,5	100,0	102 407	102 407 T	1

Gütegrad mittel für Durchgangsloch

Für Gewinde	Ø2 mm	Ø1 mm	Ø3 mm	L1 mm			
M 3	6,0	3,4	5,0	71,0	102 408	102 408 T	1
M 4	8,0	4,5	5,0	71,0	102 409	102 409 T	1
M 5	10,0	5,5	8,0	80,0	102 410	102 410 T	1
M 6	11,0	6,6	8,0	80,0	102 411	102 411 T	1
M 8	15,0	9,0	12,5	100,0	102 412	102 412 T	1
M 10	18,0	11,0	12,5	100,0	102 413	102 413 T	1
M 12	20,0	13,5	12,5	100,0	102 414	102 414 T	1

Für Gewindekernloch

Für Gewinde	Ø2 mm	Ø1 mm	Ø3 mm	L1 mm			
M 3	6,0	2,5	5,0	71,0	102 415	102 415 T	1
M 4	8,0	3,3	5,0	71,0	102 416	102 416 T	1
M 5	10,0	4,2	8,0	80,0	102 417	102 417 T	1
M 6	11,0	5,0	8,0	80,0	102 418	102 418 T	1
M 8	15,0	6,8	12,5	100,0	102 419	102 419 T	1
M 10	18,0	8,5	12,5	100,0	102 420	102 420 T	1
M 12	20,0	10,2	12,5	100,0	102 421	102 421 T	1

Flachsenker-Sätze DIN 373 HSS und HSS-TiN mit Zylinderschaft in Industriekassette

	HSS	HSS TiN
6-teiliger Flachsenker-Satz mit festem Führungszapfen, Gütegrad fein für Durchgangsloch für Gewinde: M 3 - M 4 - M 5 - M 6 - M 8 - M 10	102 450	102 450 T
6-teiliger Flachsenker-Satz mit festem Führungszapfen, Gütegrad mittel für Durchgangsloch für Gewinde: M 3 - M 4 - M 5 - M 6 - M 8 - M 10	102 451	102 451 T
6-teiliger Flachsenker-Satz mit festem Führungszapfen für Gewindekernloch für Gewinde: M 3 - M 4 - M 5 - M 6 - M 8 - M 10	102 452	102 452 T



Flachsenker-Sätze DIN 373 HSS und HSS-TiN mit Zylinderschaft in ABS-Kunststoffkassette

	HSS	HSS TiN
6-teiliger Flachsenker-Satz mit festem Führungszapfen, Gütegrad fein für Durchgangsloch für Gewinde: M 3 - M 4 - M 5 - M 6 - M 8 - M 10	102 450 RO	102 450 TRO
6-teiliger Flachsenker-Satz mit festem Führungszapfen, Gütegrad mittel für Durchgangsloch für Gewinde: M 3 - M 4 - M 5 - M 6 - M 8 - M 10	102 451 RO	102 451 TRO
6-teiliger Flachsenker-Satz mit festem Führungszapfen für Gewindekernloch für Gewinde: M 3 - M 4 - M 5 - M 6 - M 8 - M 10	102 452 RO	102 452 TRO



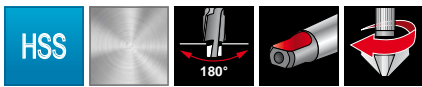

Flachsenker HSS mit Morsekegel und festem Führungzapfen

Zur Herstellung von Senkungen für Zylinderkopfschrauben, Sechskantschrauben und Muttern. Ideal zum grat- und ratterfreien Senken bei Stahl, Guß, Bunt- und Leichtmetallen. Beste Ergebnisse bei niedriger Schnittgeschwindigkeit.

Verpackungseinheit: einzeln in Kunststoffverpackung

Stahl (N/mm2) < 900	■	Messing	■
Stahl (N/mm2) < 1100		Bronze	□
Stahl (N/mm2) < 1300		Kunststoffe	■
rostfreier Stahl		Gusseisen	□
Aluminium	■	Titan legiert	

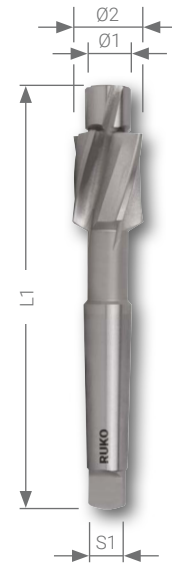

Gütegrad fein für Durchgangsloch

Für Gewinde	Ø2 mm	Ø1 mm	Schaft S1	L1 mm	HSS		
M 10	18,0	10,5	MK 2	150,0		102 422	1
M 12	20,0	13,0	MK 2	150,0		102 423	1
M 14	24,0	15,0	MK 2	160,0		102 424	1
M 16	26,0	17,0	MK 3	190,0		102 425	1
M 18	30,0	19,0	MK 3	190,0		102 426	1
M 20	33,0	21,0	MK 3	190,0		102 427	1
M 22	36,0	23,0	MK 3	205,0		102 428	1

Gütegrad mittel für Durchgangsloch

Für Gewinde	Ø2 mm	Ø1 mm	Schaft S1	L1 mm	HSS		
M 10	18,0	11,0	MK 2	150,0		102 429	1
M 12	20,0	13,5	MK 2	150,0		102 430	1
M 14	24,0	15,5	MK 2	160,0		102 431	1
M 16	26,0	17,5	MK 3	190,0		102 432	1
M 18	30,0	20,0	MK 3	190,0		102 433	1
M 20	33,0	22,0	MK 3	190,0		102 434	1
M 22	36,0	24,0	MK 3	205,0		102 435	1

Für Gewindekernloch

Für Gewinde	Ø2 mm	Ø1 mm	Schaft S1	L1 mm	HSS		
M 10	18,0	8,5	MK 2	150,0		102 436	1
M 12	20,0	10,2	MK 2	150,0		102 437	1
M 14	24,0	12,0	MK 2	160,0		102 438	1
M 16	26,0	14,0	MK 3	190,0		102 439	1
M 18	30,0	15,5	MK 3	190,0		102 440	1
M 20	33,0	17,5	MK 3	190,0		102 441	1
M 22	36,0	19,5	MK 3	205,0		102 442	1





Mehrfasenstufenbohrer "lang" Typ N HSS

Die Bohrung und Senkung wird in einem Arbeitsgang gefertigt.

Hinweis: Die Schnittgeschwindigkeit nach dem großen Durchmesser und den Vorschub nach dem kleinen Durchmesser einstellen.

Verpackungseinheit: einzeln in Kunststoffverpackung

Stahl (N/mm ²) < 900	■	Messing	■
Stahl (N/mm ²) < 1100		Bronze	□
Stahl (N/mm ²) < 1300		Kunststoffe	■
rostfreier Stahl		Gusseisen	□
Aluminium	■	Titan legiert	

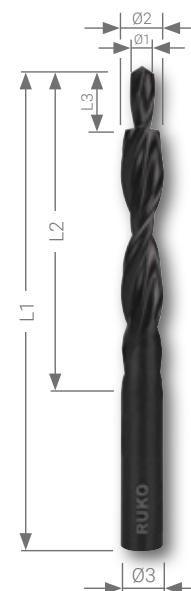

90° Gütegrad fein für Durchgangsloch

Zum rationellen Erstellen von Durchgangsbohrungen und Schraubenkopfsenkungen mit 90°.

für Gewinde	Ø1 mm	Ø2 / Ø3 mm	L3 mm	L2 mm	L1 mm	HSS		
M 3	3,2	6,0	9,0	57,0	93,0	102 601		1
M 4	4,3	8,0	11,0	75,0	117,0	102 602		1
M 5	5,3	10,0	13,0	87,0	133,0	102 603		1
M 6	6,4	11,5	15,0	94,0	142,0	102 604		1
M 8	8,4	15,0	19,0	114,0	169,0	102 605		1
M 10	10,5	19,0	23,0	135,0	198,0	102 606		1



180° Gütegrad mittel für Durchgangsloch

Zum rationellen Erstellen von Durchgangsbohrungen und Schraubenkopfsenkungen mit 180°.

für Gewinde	Ø1 mm	Ø2 / Ø3 mm	L3 mm	L2 mm	L1 mm	HSS		
M 3	3,4	6,0	9,0	57,0	93,0	102 607		1
M 4	4,5	8,0	11,0	75,0	117,0	102 608		1
M 5	5,5	10,0	13,0	87,0	133,0	102 609		1
M 6	6,6	11,0	15,0	94,0	142,0	102 610		1
M 8	9,0	15,0	19,0	114,0	169,0	102 611		1
M 10	11,0	18,0	23,0	130,0	191,0	102 612		1



90° für Gewindekernloch

Zum rationellen Erstellen von Gewindekernbohrungen und Freisenkungen mit 90°.

für Gewinde	Ø1 mm	Ø2 / Ø3 mm	L3 mm	L2 mm	L1 mm	HSS		
M 3	2,5	3,4	8,8	39,0	70,0	102 613		1
M 4	3,3	4,5	11,4	47,0	80,0	102 614		1
M 5	4,2	5,5	13,6	57,0	93,0	102 615		1
M 6	5,0	6,6	16,5	63,0	101,0	102 616		1
M 8	6,8	9,0	21,0	81,0	125,0	102 617		1
M 10	8,5	11,0	25,5	94,0	142,0	102 618		1
M 12	10,2	13,5	30,0	108,0	160,0	102 619		1

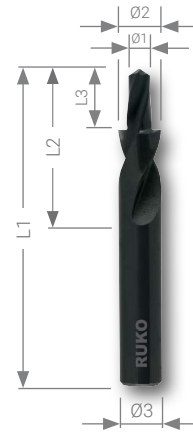

Kurzstufenbohrer Typ N HSS

Kurzer und torsionsstabiler Bohrer, geeignet für den Einsatz auf CNC- bzw. NC-Maschinen. Die Bohrung und Senkung wird in einem Arbeitsgang gefertigt. Hinweis: Die Schnittgeschwindigkeit nach dem großen Durchmesser und den Vorschub nach dem kleinen Durchmesser einstellen.

Verpackungseinheit: einzeln in Kunststoffverpackung

Stahl (N/mm ²) < 900	■	Messing	■
Stahl (N/mm ²) < 1100		Bronze	□
Stahl (N/mm ²) < 1300		Kunststoffe	■
rostfreier Stahl		Gusseisen	□
Aluminium	■	Titan legiert	

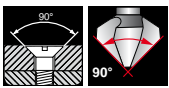

90° Gütegrad fein für Durchgangsloch

Zum rationellen Erstellen von Durchgangsbohrungen und Schraubenkopfsenkungen mit 90°.

für Gewinde	Ø1 mm	Ø2 / Ø3 mm	L3 mm	L2 mm	L1 mm	HSS		
M 3	3,2	6,0	9,0	28,0	66,0			
M 4	4,3	8,0	11,0	37,0	79,0	102 620		1
M 5	5,3	10,0	13,0	43,0	89,0	102 621		1
M 6	6,4	11,5	15,0	47,0	95,0	102 622		1
M 8	8,4	15,0	19,0	56,0	111,0	102 623		1
M 10	10,5	19,0	23,0	64,0	127,0	102 624		1
						102 625		1



180° Gütegrad mittel für Durchgangsloch

Zum rationellen Erstellen von Durchgangsbohrungen und Schraubenkopfsenkungen mit 180°.

für Gewinde	Ø1 mm	Ø2 / Ø3 mm	L3 mm	L2 mm	L1 mm	HSS		
M 3	3,4	6,0	9,0	28,0	66,0			
M 4	4,5	8,0	11,0	37,0	79,0	102 626		1
M 5	5,5	10,0	13,0	43,0	89,0	102 627		1
M 6	6,6	11,0	15,0	47,0	95,0	102 628		1
M 8	9,0	15,0	19,0	56,0	111,0	102 629		1
M 10	11,0	18,0	23,0	62,0	123,0	102 630		1
						102 631		1

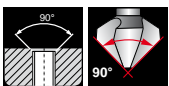

90° für Gewindekernloch

Zum rationellen Erstellen von Gewindekernbohrungen und Freisenkungen mit 90°.

für Gewinde	Ø1 mm	Ø2 / Ø3 mm	L3 mm	L2 mm	L1 mm	HSS		
M 3	2,5	3,4	8,8	20,0	52,0			
M 4	3,3	4,5	11,4	24,0	58,0	102 632		1
M 5	4,2	5,5	13,6	28,0	66,0	102 633		1
M 6	5,0	6,6	16,5	31,0	70,0	102 634		1
M 8	6,8	9,0	21,0	40,0	84,0	102 635		1
M 10	8,5	11,0	25,5	47,0	95,0	102 636		1
M 12	10,2	13,5	30,0	54,0	107,0	102 637		1
						102 638		1

Drehzahlrichtwerte für Kegel- und Entgratsenker

Material:	unlegierter Baustahl bis 700 N/mm ²	unlegierter Baustahl über 700 N/mm ²	legierter Stahl bis 1000 N/mm ²	Gußeisen bis 250 N/mm ²	Gußeisen über 250 N/mm ²	CuZn-Legierung spröde	CuZn-Legierung zäh	Aluminium-Legierung bis 11% Si	Thermoplaste	Duroplaste
Vc = m/min	20	15	10	10	8	40	20	20	15	10
Kühlschmierstoff	Schneidspray	Schneidspray	Schneidspray	Druckluft	Druckluft	Druckluft	Druckluft	Schneidspray	Wasser	Druckluft
Ø mm	U/min	U/min	U/min	U/min	U/min	U/min	U/min	U/min	U/min	U/min
4,3	1481	1111	741	741	593	2963	1481	1481	1111	741
5,0	1274	955	637	637	510	2548	1274	1274	955	637
5,3	1202	901	601	601	481	2404	1202	1202	901	601
5,8	1098	824	549	549	439	2196	1098	1098	824	549
6,0	1062	796	531	531	425	2123	1062	1062	796	531
6,3	1011	758	506	506	404	2022	1011	1011	758	506
7,0	910	682	455	455	364	1820	910	910	682	455
7,3	873	654	436	436	349	1745	873	873	654	436
8,0	796	597	398	398	318	1592	796	796	597	398
8,3	767	576	384	384	307	1535	767	767	576	384
9,4	678	508	339	339	271	1355	678	678	508	339
10,0	637	478	318	318	255	1274	637	637	478	318
10,4	612	459	306	306	245	1225	612	612	459	306
11,5	554	415	277	277	222	1108	554	554	415	277
12,0	531	398	265	265	212	1062	531	531	398	265
12,4	514	385	257	257	205	1027	514	514	385	257
12,5	510	382	255	255	204	1019	510	510	382	255
13,4	475	356	238	238	190	951	475	475	356	238
15,0	425	318	212	212	170	849	425	425	318	212
16,0	398	299	199	199	159	796	398	398	299	199
16,5	386	290	193	193	154	772	386	386	290	193
19,0	335	251	168	168	134	670	335	335	251	168
20,0	318	239	159	159	127	637	318	318	239	159
20,5	311	233	155	155	124	621	311	311	233	155
23,0	277	208	138	138	111	554	277	277	208	138
25,0	255	191	127	127	102	510	255	255	191	127
26,0	245	184	122	122	98	490	245	245	184	122
28,0	227	171	114	114	91	455	227	227	171	114
30,0	212	159	106	106	85	425	212	212	159	106
31,0	205	154	103	103	82	411	205	205	154	103
31,5	202	152	101	101	81	404	202	202	152	101
34,0	187	141	94	94	75	375	187	187	141	94
37,0	172	129	86	86	69	344	172	172	129	86
40,0	159	119	80	80	64	318	159	159	119	80
50,0	127	96	64	64	51	255	127	127	96	64
63,0	101	76	51	51	40	202	101	101	76	51
80,0	80	60	40	40	32	159	80	80	60	40

Senkungen nach DIN 74 für Senkschrauben nach DIN

Form AF	nach DIN 74	Form BF
DIN 963 / DIN 964 DIN 965 / DIN 966 DIN 7513 F. u. G. DIN 7516 D. u. E.		DIN 7991 (ISO 10642)



Drehzahlrichtwerte für VHM Senker

Material:	unlegierter Baustahl bis 700 N/mm ²		unlegierter Baustahl über 700 N/mm ²		legierter Stahl bis 1200 N/mm ²		Gußeisen bis 250 N/mm ²		Gußeisen über 250 N/mm ²		CuZn-Legierung spröde		CuZn-Legierung zäh		Aluminium-Legierung bis 11% Si		Thermoplaste		Duroplaste	
Vc = m/min	15		12		8		12		10		25		15		20		20		10	
Ø mm	U/min	f	U/min	f	U/min	f	U/min	f	U/min	f	U/min	f	U/min	f	U/min	f	U/min	f	U/min	f
6,3	758	0,10	606	0,10	404	0,10	606	0,15	505	0,15	1263	0,13	758	0,13	1011	0,13	1011	0,13	505	0,13
8,3	575	0,15	460	0,15	307	0,15	460	0,20	384	0,20	959	0,16	575	0,16	767	0,16	767	0,18	384	0,18
10,4	459	0,15	367	0,15	245	0,15	367	0,20	306	0,20	765	0,16	459	0,16	612	0,16	612	0,20	306	0,20
12,4	385	0,20	308	0,20	205	0,20	308	0,25	257	0,25	642	0,20	385	0,20	513	0,20	513	0,20	257	0,20
16,5	289	0,20	231	0,20	154	0,20	231	0,25	193	0,25	482	0,22	289	0,22	386	0,22	386	0,25	193	0,25
20,5	233	0,25	186	0,25	124	0,25	186	0,30	155	0,30	388	0,25	233	0,25	311	0,25	311	0,25	155	0,25
25,0	191	0,30	153	0,30	102	0,30	153	0,30	127	0,30	318	0,25	191	0,25	255	0,25	255	0,30	127	0,30
31,0	154	0,35	123	0,35	82	0,35	123	0,35	103	0,35	257	0,30	154	0,30	205	0,30	205	0,35	103	0,35

f in mm/U = Vorschub je Umdrehung

Senkungen nach DIN 74 Blatt 2

Senkungen der Form H

für Zylinderschrauben nach DIN 84 und DIN 7984
für Gewinde-Schneidschrauben nach DIN 7513, Form B
für Gewindefurchende Schrauben DIN 7500, Form B

Senkungen der Form J

für Zylinderschrauben nach DIN 6912

Senkungen der Form K

für Zylinderschrauben nach DIN 912

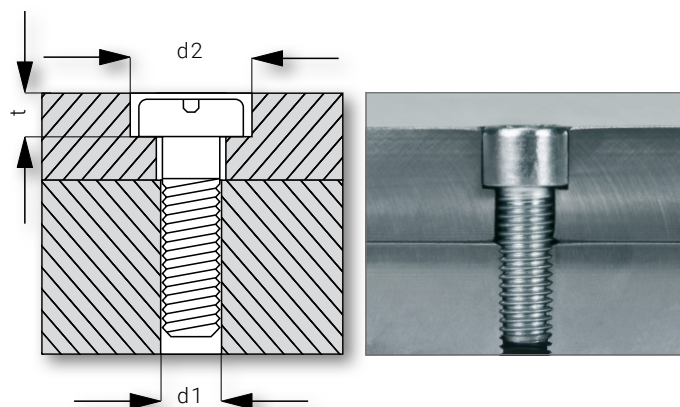

Für Gewinde	d1 fein H 12 mm	d1 mittel H 13 mm	d1 Kernloch mm	d2 H 13 mm	t Form H mm	t Form J mm	t Form K mm	Toleranz für t mm
M 3	3,2	3,4	2,5	6,0	2,4	—	3,4	0 + 0,1
M 4	4,3	4,5	3,3	8,0	3,2	3,4	4,6	0 + 0,4
M 5	5,3	5,5	4,2	10,0	4,0	4,2	5,7	0 + 0,4
M 6	6,4	6,6	5,0	11,0	4,7	4,8	6,8	0 + 0,4
M 8	8,4	9,0	6,8	15,0	6,0	6,0	6,0	0 + 0,4
M 10	10,5	11,0	8,5	18,0	7,0	7,5	11,0	0 + 0,4
M 12	13,0	13,5	10,2	20,0	8,0	8,5	13,0	0 + 0,4
M 14	15,0	15,5	12,0	24,0	9,0	9,5	15,0	0 + 0,4
M 16	17,0	17,5	14,0	26,0	10,5	11,5	17,5	0 + 0,4
M 18	19,0	20,0	15,5	30,0	11,5	12,5	19,5	0 + 0,4
M 20	21,0	22,0	17,5	33,0	12,5	13,5	21,5	0 + 0,4
M 22	23,0	24,0	19,5	36,0	13,5	14,5	23,5	0 + 0,4

Form A für:

- Senkschrauben nach DIN 963 und DIN 965
- Linsensenkschrauben nach DIN 964 / DIN 966
- Gewindefurchende Schrauben Form F / G DIN 7513 und Form D / E DIN 7516
- Gewindefurchende Schrauben Form K, L, M und N nach DIN 7500
- Senkholzschrauben nach DIN 97 / DIN 7997
- Linsensenkholzschrauben nach DIN 95 / DIN 7997

Form B für:

- Innensechskant- Senkschrauben DIN 7991

