











FRÄSSTIFTE

FASCINATION  PRECISION®

Artikel- und Anwendungs- übersicht:



Werkstoff	Oberfläche	DIN	Form	Verzahnung	Schaft	Ø mm	Art. Nr.	Seite
TC		DIN 8033	A	ZYA	CT 4	3,0 - 16,0	116 010 116 046	216
TC	TiCN	DIN 8033	A	ZYA	CT 4	6,0 - 16,0	116 010 TC 116 014 TC	216
TC		DIN 8033	B	ZYAS	CT 4	3,0 - 16,0	116 015 116 047	216
TC	TiCN	DIN 8033	B	ZYAS	CT 4	6,0 - 16,0	116 015 TC 116 019 TC	216
TC		DIN 8033	B	ZYAS	ALU	6,0 - 12,0	116 015 A 116 018 A	216
TC		DIN 8033	C	WRC	CT 4	3,0 - 16,0	116 020 116 048	217
TC	TiCN	DIN 8033	C	WRC	CT 4	6,0 - 16,0	116 020 TC 116 024 TC	217
TC		DIN 8033	C	WRC	ALU	6,0 - 12,0	116 020 A 116 023 A	217
TC		DIN 8033	D	KUD	CT 4	3,0 - 16,0	116 041 116 052	217
TC	TiCN	DIN 8033	D	KUD	CT 4	6,0 - 16,0	116 041 TC 116 045 TC	217
TC		DIN 8033	D	KUD	ALU	6,0 - 12,0	116 041 A 116 044 A	217
TC		DIN 8033	E	TRE	CT 4	3,0 - 16,0	116 210 116 215	218
TC		DIN 8033	F	RBF	CT 4	3,0 - 16,0	116 030 116 050	218
TC	TiCN	DIN 8033	F	RBF	CT 4	6,0 - 16,0	116 030 TC 116 034 TC	218
TC		DIN 8033	F	RBF	ALU	6,0 - 12,0	116 030 A 116 033 A	218
TC		DIN 8033	G	SPG	CT 4	3,0 - 16,0	116 025 116 049	219
TC	TiCN	DIN 8033	G	SPG	CT 4	6,0 - 16,0	116 025 TC 116 029 TC	219
TC		DIN 8033	G	SPG	ALU	6,0 - 12,0	116 025 A 116 028 A	219
TC		DIN 8033	H	FLH	CT 4	3,0 - 16,0	116 216 116 221	219
TC		DIN 8033	J	KSJ	CT 4	3,0 - 16,0	116 222 116 226	220
TC		DIN 8033	K	KSK	CT 4	3,0 - 16,0	116 227 116 231	220
TC		DIN 8033	L	KEL	CT 4	3,0 - 16,0	116 232 116 237	221
TC		DIN 8033	L	KEL	ALU	6,0 - 12,0	116 233 A 116 236 A	221
TC		DIN 8033	M	SKM	CT 4	3,0 - 16,0	116 035 116 051	221
TC	TiCN	DIN 8033	M	SKM	CT 4	6,0 - 16,0	116 035 TC 116 039 TC	221
TC		DIN 8033	N	WKN	CT 4	3,0 - 16,0	116 238 116 242	222

Stahl (N/mm ²) < 900 	Stahl (N/mm ²) < 1100 	Stahl (N/mm ²) < 1300 	rostfreier Stahl 	Aluminium AL 	Messing 3% 	Bronze 5% 	Kunststoffe Plastic 	Gusseisen 	Titan legiert Ti 
■	■	■	■		■			■	■
■	■	■	■		■			■	■
■	■	■	■		■			■	■
■	■	■	■		■			■	■
				■		■	■		
■	■	■	■		■			■	■
■	■	■	■		■			■	■
				■		■	■		
■	■	■	■		■			■	■
■	■	■	■		■			■	■
				■		■	■		
■	■	■	■		■			■	■
■	■	■	■		■			■	■
■	■	■	■		■			■	■
				■		■	■		
■	■	■	■		■			■	■
■	■	■	■		■			■	■
■	■	■	■		■			■	■
				■		■	■		
■	■	■	■		■			■	■
■	■	■	■		■			■	■
■	■	■	■		■			■	■
				■		■	■		
■	■	■	■		■			■	■
■	■	■	■		■			■	■
■	■	■	■		■			■	■



Hartmetall-Frässtifte Form A Zylinder (ZYA) ohne Stirnverzahnung

Verpackungseinheit: einzeln in Kunststoffverpackung

	CT4	CT4
Stahl (N/mm2) < 900	■	■
Stahl (N/mm2) < 1100	■	■
Stahl (N/mm2) < 1300	■	■
rostfreier Stahl	■	■
Aluminium		

	CT4	CT4
Messing	■	■
Bronze		
Kunststoffe		
Gusseisen	■	■
Titan legiert	■	■

Ø1 mm	L2 mm	L1 mm	Ø2 mm	TC	ALU	TC	CT 4	TC	TICN	CT 4	
3,0	14,0	38,0	3,0	—		116 046		—			1
6,0	18,0	58,0	6,0	—		116 010		116 010 TC			1
8,0	18,0	60,0	6,0	—		116 011		116 011 TC			1
10,0	20,0	60,0	6,0	—		116 012		116 012 TC			1
12,0	25,0	65,0	6,0	—		116 013		116 013 TC			1
16,0	25,0	65,0	6,0	—		116 014		116 014 TC			1

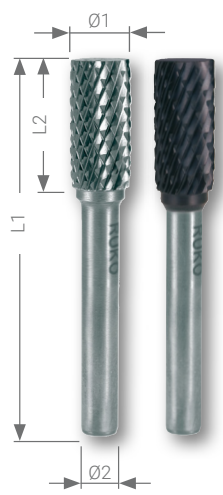

Hartmetall-Frässtifte Form B Zylinder (ZYAS) mit Stirnverzahnung

Verpackungseinheit: einzeln in Kunststoffverpackung

	ALU	CT4	CT4
Stahl (N/mm2) < 900		■	■
Stahl (N/mm2) < 1100		■	■
Stahl (N/mm2) < 1300		■	■
rostfreier Stahl		■	■
Aluminium	■		

	ALU	CT4	CT4
Messing		■	■
Bronze	■		
Kunststoffe	■		
Gusseisen		■	■
Titan legiert		■	■

Ø1 mm	L2 mm	L1 mm	Ø2 mm	TC	ALU	TC	CT 4	TC	TICN	CT 4	
3,0	14,0	38,0	3,0	—		116 047		—			1
6,0	18,0	58,0	6,0	116 015 A		116 015		116 015 TC			1
8,0	18,0	60,0	6,0	—		116 016		116 016 TC			1
10,0	20,0	60,0	6,0	—		116 017		116 017 TC			1
12,0	25,0	65,0	6,0	116 018 A		116 018		116 018 TC			1
16,0	25,0	65,0	6,0	—		116 019		116 019 TC			1

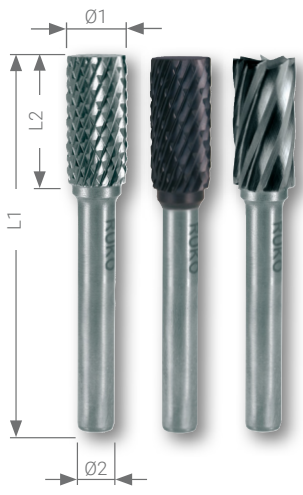



Hartmetall-Frässtifte Form C Walzenrund (WRC)

Verpackungseinheit: einzeln in Kunststoffverpackung

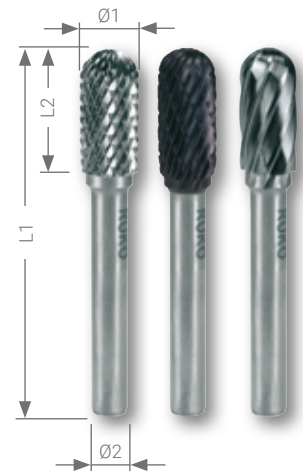

	ALU	CT4	CT4		ALU	CT4	CT4
Stahl (N/mm ²) < 900		■	■	Messing		■	■
Stahl (N/mm ²) < 1100		■	■	Bronze	■		
Stahl (N/mm ²) < 1300		■	■	Kunststoffe	■		
rostfreier Stahl		■	■	Gusseisen		■	■
Aluminium	■			Titan legiert		■	■

Ø1 mm	L2 mm	L1 mm	Ø2 mm	TC	ALU	TC	CT4	TC	TiCN	CT4	
3,0	14,0	43,0	3,0	—			116 048	—			1
6,0	16,0	56,0	6,0	116 020 A			116 020			116 020 TC	1
8,0	16,0	56,0	6,0	—			116 021			116 021 TC	1
10,0	20,0	60,0	6,0	—			116 022			116 022 TC	1
12,0	25,0	65,0	6,0	116 023 A			116 023			116 023 TC	1
16,0	25,0	65,0	6,0	—			116 024			116 024 TC	1



Hartmetall-Frässtifte Form D Kugel (KUD)

Verpackungseinheit: einzeln in Kunststoffverpackung

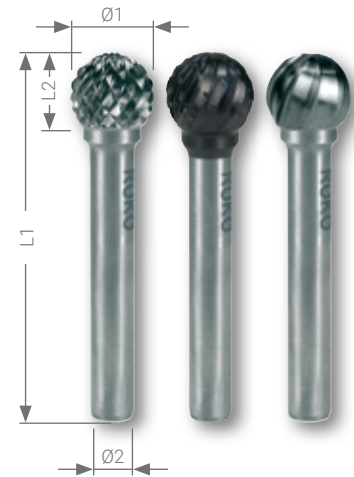

	ALU	CT4	CT4		ALU	CT4	CT4
Stahl (N/mm ²) < 900		■	■	Messing		■	■
Stahl (N/mm ²) < 1100		■	■	Bronze	■		
Stahl (N/mm ²) < 1300		■	■	Kunststoffe	■		
rostfreier Stahl		■	■	Gusseisen		■	■
Aluminium	■			Titan legiert		■	■

Ø1 mm	L2 mm	L1 mm	Ø2 mm	TC	ALU	TC	CT4	TC	TiCN	CT4	
3,0	2,7	33,0	3,0	—			116 052	—			1
6,0	5,4	45,0	6,0	116 041 A			116 041			116 041 TC	1
8,0	7,2	47,0	6,0	—			116 042			116 042 TC	1
10,0	9,0	49,0	6,0	—			116 043			116 043 TC	1
12,0	11,0	51,0	6,0	116 044 A			116 044			116 044 TC	1
16,0	14,4	54,0	6,0	—			116 045			116 045 TC	1



Hartmetall-Frässtifte Form E Tropfen (TRE)

Verpackungseinheit: einzeln in Kunststoffverpackung

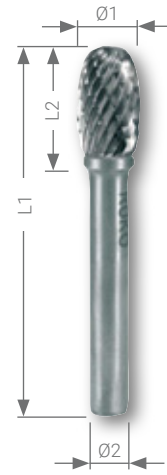

Stahl (N/mm2) < 900	■	Messing	■
Stahl (N/mm2) < 1100	■	Bronze	
Stahl (N/mm2) < 1300	■	Kunststoffe	
rostfreier Stahl	■	Gusseisen	■
Aluminium		Titan legiert	■

Ø1 mm	L2 mm	L1 mm	Ø2 mm	TC	ALU	TC	CT 4	TC	TiCN	CT 4	
3,0	7,0	37,0	3,0	—			116 210	—			1
6,0	10,0	50,0	6,0	—			116 211	—			1
8,0	13,0	53,0	6,0	—			116 212	—			1
10,0	16,0	56,0	6,0	—			116 213	—			1
12,0	20,0	60,0	6,0	—			116 214	—			1
16,0	25,0	65,0	6,0	—			116 215	—			1



Hartmetall-Frässtifte Form F Rundbogen (RBF)

Verpackungseinheit: einzeln in Kunststoffverpackung



Stahl (N/mm2) < 900		■	■	Messing		■	■
Stahl (N/mm2) < 1100		■	■	Bronze	■		
Stahl (N/mm2) < 1300		■	■	Kunststoffe	■		
rostfreier Stahl		■	■	Gusseisen		■	■
Aluminium	■			Titan legiert		■	■

Ø1 mm	L2 mm	L1 mm	Ø2 mm	TC	ALU	TC	CT 4	TC	TiCN	CT 4	
3,0	7,0	37,0	3,0	—			116 050	—			1
6,0	18,0	58,0	6,0	116 030 A			116 030	116 030 TC			1
8,0	18,0	60,0	6,0	—			116 031	116 031 TC			1
10,0	20,0	60,0	6,0	—			116 032	116 032 TC			1
12,0	25,0	65,0	6,0	116 033 A			116 033	116 033 TC			1
16,0	30,0	70,0	6,0	—			116 034	116 034 TC			1



Hartmetall-Frässtifte Form G Spitzbogen (SPG)

Verpackungseinheit: einzeln in Kunststoffverpackung

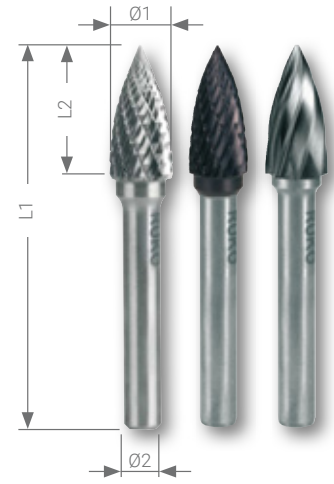

	ALU	CT4	CT4		ALU	CT4	CT4
Stahl (N/mm2) < 900		■	■	Messing		■	■
Stahl (N/mm2) < 1100		■	■	Bronze	■		
Stahl (N/mm2) < 1300		■	■	Kunststoffe	■		
rostfreier Stahl		■	■	Gusseisen		■	■
Aluminium	■			Titan legiert		■	■

Ø1 mm	L2 mm	L1 mm	Ø2 mm	TC	ALU	TC	CT4	TC	TICN	CT4	
3,0	13,0	38,0	3,0	—		116 049		—			1
6,0	18,0	58,0	6,0	116 025 A		116 025		116 025 TC			1
8,0	18,0	60,0	6,0	—		116 026		116 026 TC			1
10,0	20,0	60,0	6,0	—		116 027		116 027 TC			1
12,0	25,0	65,0	6,0	116 028 A		116 028		116 028 TC			1
16,0	25,0	70,0	6,0	—		116 029		116 029 TC			1



Hartmetall-Frässtifte Form H Flamme (FLH)

Verpackungseinheit: einzeln in Kunststoffverpackung

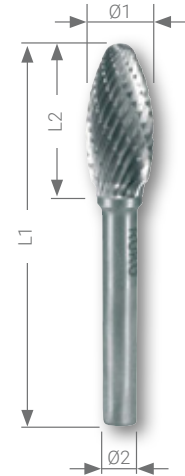

	CT4		CT4
Stahl (N/mm2) < 900	■	Messing	■
Stahl (N/mm2) < 1100	■	Bronze	
Stahl (N/mm2) < 1300	■	Kunststoffe	
rostfreier Stahl	■	Gusseisen	■
Aluminium		Titan legiert	■

Ø1 mm	L2 mm	L1 mm	Ø2 mm	TC	ALU	TC	CT4	TC	TICN	CT4	
3,0	14,0	38,0	3,0	—		116 216		—			1
6,0	13,0	50,0	6,0	—		116 217		—			1
8,0	20,0	65,0	6,0	—		116 218		—			1
10,0	20,0	65,0	6,0	—		116 219		—			1
12,0	30,0	75,0	6,0	—		116 220		—			1
16,0	35,0	80,0	6,0	—		116 221		—			1



Hartmetall-Frässtifte Form J Kegel 60° (KSJ)

Verpackungseinheit: einzeln in Kunststoffverpackung



Stahl (N/mm ²) < 900	■	Messing	■
Stahl (N/mm ²) < 1100	■	Bronze	
Stahl (N/mm ²) < 1300	■	Kunststoffe	
rostfreier Stahl	■	Gusseisen	■
Aluminium		Titan legiert	■

Ø1 mm	L2 mm	L1 mm	Ø2 mm	TC	ALU	TC	CT 4	TC	TICN	CT 4	
3,0	3,0	38,0	3,0	—		116 222		—			1
6,0	5,0	50,0	6,0	—		116 223		—			1
10,0	8,7	53,0	6,0	—		116 224		—			1
12,0	11,0	60,0	6,0	—		116 225		—			1
16,0	13,8	65,0	6,0	—		116 226		—			1



Hartmetall-Frässtifte Form K Kegel 90° (KSK)

Verpackungseinheit: einzeln in Kunststoffverpackung

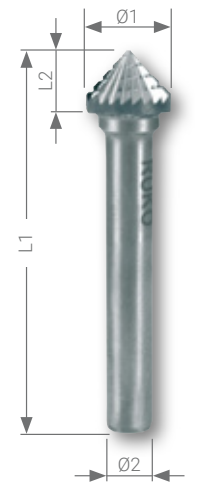

Stahl (N/mm ²) < 900	■	Messing	■
Stahl (N/mm ²) < 1100	■	Bronze	
Stahl (N/mm ²) < 1300	■	Kunststoffe	
rostfreier Stahl	■	Gusseisen	■
Aluminium		Titan legiert	■

Ø1 mm	L2 mm	L1 mm	Ø2 mm	TC	ALU	TC	CT 4	TC	TICN	CT 4	
3,0	3,0	38,0	3,0	—		116 227		—			1
6,0	5,0	50,0	6,0	—		116 228		—			1
10,0	5,0	50,0	6,0	—		116 229		—			1
12,0	8,0	53,0	6,0	—		116 230		—			1
16,0	8,0	53,0	6,0	—		116 231		—			1



Hartmetall-Frässtifte Form L Rundkegel (KEL)

Verpackungseinheit: einzeln in Kunststoffverpackung

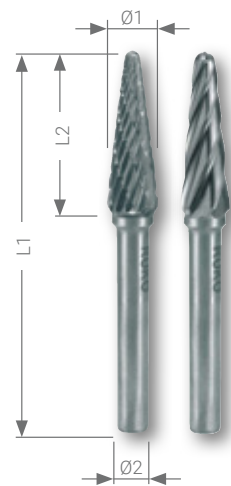

	ALU	CT 4		ALU	CT 4
Stahl (N/mm ²) < 900		■	Messing		■
Stahl (N/mm ²) < 1100		■	Bronze	■	
Stahl (N/mm ²) < 1300		■	Kunststoffe	■	
rostfreier Stahl		■	Gusseisen		■
Aluminium	■		Titan legiert		■

Ø1 mm	L2 mm	L1 mm	Ø2 mm	TC	ALU	TC	CT 4	TC	TICN	CT 4	
3,0	12,0	38,0	3,0	—		116 232		—			1
6,0	18,0	52,0	6,0	116 233 A		116 233		—			1
8,0	20,0	60,0	6,0	—		116 234		—			1
10,0	20,0	60,0	6,0	116 235 A		116 235		—			1
12,0	30,0	70,0	6,0	116 236 A		116 236		—			1
16,0	30,0	70,0	6,0	—		116 237		—			1



Hartmetall-Frässtifte Form M Spitzkegel (SKM)

Verpackungseinheit: einzeln in Kunststoffverpackung

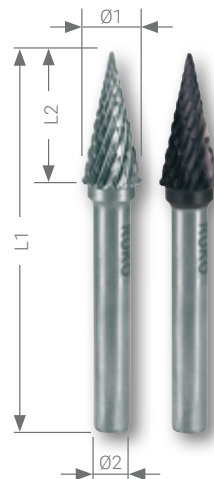

	CT 4	CT 4		CT 4	CT 4
Stahl (N/mm ²) < 900	■	■	Messing	■	■
Stahl (N/mm ²) < 1100	■	■	Bronze		
Stahl (N/mm ²) < 1300	■	■	Kunststoffe		
rostfreier Stahl	■	■	Gusseisen	■	■
Aluminium			Titan legiert	■	■

Ø1 mm	L2 mm	L1 mm	Ø2 mm	TC	ALU	TC	CT 4	TC	TICN	CT 4	
3,0	11,0	41,0	3,0	—		116 051		—			1
6,0	18,0	58,0	6,0	—		116 035		116 035 TC			1
8,0	20,0	60,0	6,0	—		116 036		116 036 TC			1
10,0	20,0	60,0	6,0	—		116 037		116 037 TC			1
12,0	25,0	65,0	6,0	—		116 038		116 038 TC			1
16,0	25,0	65,0	6,0	—		116 039		116 039 TC			1

Hartmetall-Frässtifte Form N Winkel (WKN)

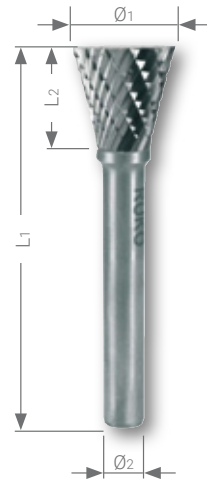

Verpackungseinheit: einzeln in Kunststoffverpackung

Stahl (N/mm ²) < 900	■	Messing	■
Stahl (N/mm ²) < 1100	■	Bronze	
Stahl (N/mm ²) < 1300	■	Kunststoffe	
rostfreier Stahl	■	Gusseisen	■
Aluminium		Titan legiert	■

Ø1 mm	L2 mm	L1 mm	Ø2 mm	TC	ALU	TC	CT 4	TC	TiCN	CT 4	
3,0	7,0	37,0	3,0	—			116 238	—			1
6,0	7,0	47,0	6,0	—			116 239	—			1
10,0	13,0	53,0	6,0	—			116 240	—			1
12,0	13,0	53,0	6,0	—			116 241	—			1
16,0	13,0	53,0	6,0	—			116 242	—			1



Hartmetall-Frässtift-Sätze in Industriekassette

<p>TC</p>  <p>CT4</p>	<p>10-teiliger Hartmetall-Frässtift-Satz HM</p> <p>2 x Form A Zylinder (ZYA) ohne Stirnverzahnung Ø D1 10,0 / 12,0 mm 2 x Form C Walzenrund (WRC) Ø D1 10,0 / 12,0 mm 2 x Form G Spitzbogen (SPG) Ø D1 10,0 / 12,0 mm 2 x Form F Rundbogen (RBF) Ø D1 10,0 / 12,0 mm 1 x Form M Spitzkegel (SKM) Ø D1 12,0 mm 1 x Form D Kugel (KUD) Ø D1 12,0 mm</p>	116 003
<p>TC</p>  <p>TiCN</p> <p>CT4</p>	<p>10-teiliger Hartmetall-Frässtift-Satz TiCN</p> <p>2 x Form A Zylinder (ZYA) ohne Stirnverzahnung Ø D1 10,0 / 12,0 mm 2 x Form C Walzenrund (WRC) Ø D1 10,0 / 12,0 mm 2 x Form G Spitzbogen (SPG) Ø D1 10,0 / 12,0 mm 2 x Form F Rundbogen (RBF) Ø D1 10,0 / 12,0 mm 1 x Form M Spitzkegel (SKM) Ø D1 12,0 mm 1 x Form D Kugel (KUD) Ø D1 12,0 mm</p>	116 003 TC
<p>TC</p>  <p>ALU</p>	<p>10-teiliger Hartmetall-Frässtift-Satz ALU</p> <p>2 x Form B Zylinder (ZYAS) mit Stirnverzahnung Ø D1 6,0 / 12,0 mm 2 x Form C Walzenrund (WRC) Ø D1 6,0 / 12,0 mm 2 x Form G Spitzbogen (SPG) Ø D1 6,0 / 12,0 mm 2 x Form F Rundbogen (RBF) Ø D1 6,0 / 12,0 mm 2 x Form D Kugel (KUD) Ø D1 6,0 / 12,0 mm</p>	116 103 A



Hartmetall-Frässtift-Sätze in ABS-Kunststoffkassette

<p>TC</p>  <p>CT4</p>	<p>10-teiliger Hartmetall-Frässtift-Satz HM</p> <p>2 x Form A Zylinder (ZYA) ohne Stirnverzahnung Ø D1 10,0 / 12,0 mm 2 x Form C Walzenrund (WRC) Ø D1 10,0 / 12,0 mm 2 x Form G Spitzbogen (SPG) Ø D1 10,0 / 12,0 mm 2 x Form F Rundbogen (RBF) Ø D1 10,0 / 12,0 mm 1 x Form M Spitzkegel (SKM) Ø D1 12,0 mm 1 x Form D Kugel (KUD) Ø D1 12,0 mm</p>	116 003 RO
<p>TC</p>  <p>TiCN</p> <p>CT4</p>	<p>10-teiliger Hartmetall-Frässtift-Satz TiCN</p> <p>2 x Form A Zylinder (ZYA) ohne Stirnverzahnung Ø D1 10,0 / 12,0 mm 2 x Form C Walzenrund (WRC) Ø D1 10,0 / 12,0 mm 2 x Form G Spitzbogen (SPG) Ø D1 10,0 / 12,0 mm 2 x Form F Rundbogen (RBF) Ø D1 10,0 / 12,0 mm 1 x Form M Spitzkegel (SKM) Ø D1 12,0 mm 1 x Form D Kugel (KUD) Ø D1 12,0 mm</p>	116 003 TCRO
<p>TC</p>  <p>ALU</p>	<p>10-teiliger Hartmetall-Frässtift-Satz ALU</p> <p>2 x Form B Zylinder (ZYAS) mit Stirnverzahnung Ø D1 6,0 / 12,0 mm 2 x Form C Walzenrund (WRC) Ø D1 6,0 / 12,0 mm 2 x Form G Spitzbogen (SPG) Ø D1 6,0 / 12,0 mm 2 x Form F Rundbogen (RBF) Ø D1 6,0 / 12,0 mm 2 x Form D Kugel (KUD) Ø D1 6,0 / 12,0 mm</p>	116 103 ARO





Hartmetall-Frässtift-Module im praktischen Verkaufsdisplay

 	<p>35-teiliges Hartmetall-Frässtifte-Modul HM im praktischen Verkaufsdisplay je 1 x Ø D1 6,0 mm - 8,0 mm - 10,0 mm - 12,0 mm - 16,0 mm</p> <p>5 Frässtifte Form A Zylinder (ZYA) ohne Stirnverzahnung 5 Frässtifte Form B Zylinder (ZYAS) mit Stirnverzahnung 5 Frässtifte Form C Walzenrund (WRC) 5 Frässtifte Form G Spitzbogen (SPG) 5 Frässtifte Form F Rundbogen (RBF) 5 Frässtifte Form M Spitzkegel (SKM) 5 Frässtifte Form D Kugel (KUD)</p>	116 008
 	<p>35-teiliges Hartmetall-Frässtifte-Modul TiCN im praktischen Verkaufsdisplay je 1 x Ø D1 6,0 mm - 8,0 mm - 10,0 mm - 12,0 mm - 16,0 mm</p> <p>5 Frässtifte Form A Zylinder (ZYA) ohne Stirnverzahnung 5 Frässtifte Form B Zylinder (ZYAS) mit Stirnverzahnung 5 Frässtifte Form C Walzenrund (WRC) 5 Frässtifte Form G Spitzbogen (SPG) 5 Frässtifte Form F Rundbogen (RBF) 5 Frässtifte Form M Spitzkegel (SKM) 5 Frässtifte Form D Kugel (KUD)</p>	116 008 TC



116 008



116 008 TC



Hartmetall-Frässtifte-Sätze in Mini-Boxen

 	<p>3-teiliger Hartmetall-Frässtifte-Satz in Mini-Box je 1 x Ø 10,0 mm</p> <p>1 Frässtift Form B, Zylinder (ZYAS) mit Stirnverzahnung 1 Frässtift Form G, Spitzbogen (SPG) 1 Frässtift Form D, Kugel (KUD)</p>	116 001
 	<p>10-teiliger Hartmetall-Frässtifte-Satz in Mini-Box je 1 x Ø D1 6,0 + Ø D1 12,0 mm</p> <p>2 Frässtifte Form B, Zylinder (ZYAS) mit Stirnverzahnung 2 Frässtifte Form C, Walzenrund (WRC) 2 Frässtifte Form G, Spitzbogen (SPG) 2 Frässtifte Form F, Rundbogen (RBF) 2 Frässtifte Form D, Kugel (KUD)</p>	116 002
 	<p>5-teiliger Hartmetall-Frässtifte-Satz in Mini-Box je 1 x Ø D1 10,0 mm</p> <p>1 Frässtift Form B, Zylinder (ZYAS) mit Stirnverzahnung 1 Frässtift Form C, Walzenrund (WRC) 1 Frässtift Form G, Spitzbogen (SPG) 1 Frässtift Form F, Rundbogen (RBF) 1 Frässtift Form D, Kugel (KUD)</p>	116 004







116 001

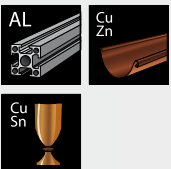

116 002

Drehzahlrichtwerte für Hartmetallfrässtifte

Werkstoffgruppen		Bearbeitungsfall	Schnittgeschwindigkeit
Stahl, Stahlguss 	Ungehärtete, nicht vergütete Stähle bis 1200 N/mm ² (< 38 HRC)	Baustähle, Kohlenstoffstähle, Werkzeugstähle, unlegierte Stähle, Einsatzstähle, Stahlguss	Grobes Zerspanen = hoher Materialabtrag 250 - 350 m/min
	Gehärtete, vergütete Stähle über 1200 N/mm ² (> 38 HRC)	Werkzeugstähle, Vergütungsstähle, legierte Stähle, Stahlguss	250 - 350 m/min
Edelstahl 	Rost- und säurebeständige Stähle	Austenitische und ferritische Edelstähle	Grobes Zerspanen = hoher Materialabtrag 250 - 350 m/min
NE-Metalle 	Weiche NE-Metalle, Buntmetalle	Alu-Legierungen, Messing, Kupfer, Zink	Grobes Zerspanen = hoher Materialabtrag 600 - 900 m/min
	Harte NE-Metalle	Bronze, Titan/Titanlegierungen, harte Alu-Legierungen (hoher Si-Anteil)	250 - 350 m/min
	Hochwarmfeste Werkstoffe	Nickelbasis- und Kobaltbasislegierungen (Triebwerk- und Turbinenbau)	300 - 450 m/min
Gusseisen 	Graues Gusseisen, weißes Gusseisen	Gusseisen mit Lamellengraphit, mit Kugelgraphit/Sphäroguss, weißer Temperguss, schwarzer Temperguss	Grobes Zerspanen = hoher Materialabtrag 600 - 900 m/min
Kunststoffe, andere Werkstoffe 	Faserverstärkte Kunststoffe, thermoplastische Kunststoffe, Hartgummi	Grobes Zerspanen = hoher Materialabtrag	500 - 1.100 m/min
		Feines Zerspanen = geringer Materialabtrag	

Schnittgeschwindigkeit V _c = m/min	250	300	350	400	450	500	600	900
Ø mm	U/min	U/min	U/min	U/min	U/min	U/min	U/min	U/min
3,0	27.000	32.000	37.000	44.000	48.000	54.000	64.000	95.000
4,0	20.000	24.000	28.000	32.000	36.000	40.000	48.000	72.000
6,0	13.000	16.000	19.000	21.000	24.000	27.000	32.000	48.000
8,0	10.000	12.000	14.000	16.000	18.000	20.000	24.000	36.000
10,0	8.000	10.000	11.000	13.000	14.000	16.000	19.000	29.000
12,0	7.000	8.000	9.000	11.000	12.000	13.000	16.000	24.000
16,0	5.000	6.000	7.000	8.000	9.000	10.000	12.000	18.000



Druckluftschleifer (kurz)

Der RUKO Druckluftschleifer in der kurzen Ausführung -
Die kompakte, schnelle Maschine zum Entgraten, Polieren und zur Schweißnahtbearbeitung!

Der RUKO Druckluftschleifer verfügt über einen gummierten, rutschfesten Handgriff, der Vibrationen dämpft und den Anwender vor dem Abrutschen während des Arbeitens schützt. Die Drehzahl ist durch einen Regler oben am Werkzeug einstellbar. Er verfügt über eine Werkzeugaufnahme aus gehärtetem Stahl. Die Abluft wird durch den Handgriff mittels 360° Rotationsprinzip nach hinten abgeführt. Der RUKO Druckluftschleifer verfügt über einen integrierten Luftfilter, der den Motor vor Verunreinigungen schützt, die mit der Druckluft ins Innere gelangen könnten.



Anschlussadapter inklusive!

Verpackungseinheit: in Kartonverpackung

	L1 mm	Ø	Artikel-Nr.	
Druckluftschleifer (kurz)	157,0	G 1/4"	116 100 L	1



Druckluftschleifer (90° Winkelkopf)

Der RUKO Druckluftschleifer in der kurzen Ausführung -
Die kompakte, schnelle Maschine zum Entgraten, Polieren und zur Schweißnahtbearbeitung!

Der RUKO Druckluftschleifer verfügt über einen gummierten, rutschfesten Handgriff, der Vibrationen dämpft und den Anwender vor dem Abrutschen während des Arbeitens schützt. Die Drehzahl ist durch einen Regler oben am Werkzeug einstellbar. Er verfügt über eine Werkzeugaufnahme aus gehärtetem Stahl. Die Abluft wird durch den Handgriff mittels 360° Rotationsprinzip nach hinten abgeführt. Der RUKO Druckluftschleifer verfügt über einen integrierten Luftfilter, der den Motor vor Verunreinigungen schützt, die mit der Druckluft ins Innere gelangen könnten. Der 90° Winkelkopf erleichtert das Arbeiten an engen und schwer zugänglichen Stellen.



Anschlussadapter inklusive!

Verpackungseinheit: in Kartonverpackung

	L1 mm	Ø	Artikel-Nr.	
Druckluftschleifer (90°)	162,0	G 1/4"	116 110 L	1



Druckluftschleifer (115° Winkelkopf)

Der RUKO Druckluftschleifer mit 115° Winkelkopf - Die kompakte, schnelle Maschine zum Entgraten, Polieren und zur Schweißnahtbearbeitung!

Der RUKO Druckluftschleifer verfügt über einen gummierten, rutschfesten Handgriff, der Vibrationen dämpft und den Anwender vor dem Abrutschen während des Arbeitens schützt. Die Drehzahl ist durch einen Regler oben am Werkzeug einstellbar. Er verfügt über eine Werkzeugaufnahme aus gehärtetem Stahl. Die Abluft wird durch den Handgriff mittels 360° Rotationsprinzip nach hinten abgeführt. Der RUKO Druckluftschleifer verfügt über einen integrierten Luftfilter, der den Motor vor Verunreinigungen schützt, die mit der Druckluft ins Innere gelangen könnten. Der 115° Winkelkopf erleichtert das Arbeiten an engen und schwer zugänglichen Stellen.



Anschlussadapter inklusive!

Verpackungseinheit: in Kartonverpackung

	L1 mm	Ø	Artikel-Nr.	
Druckluftschleifer (115°)	201,0	G 1/4"	116 120 L	1



Druckluftschleifer (lang)

Der RUKO Druckluftschleifer in der langen Ausführung - Die kompakte, schnelle Maschine zum Entgraten, Polieren und zur Schweißnahtbearbeitung!

Der RUKO Druckluftschleifer verfügt über einen gummierten, rutschfesten Handgriff, der Vibrationen dämpft und den Anwender vor dem Abrutschen während des Arbeitens schützt. Die Drehzahl ist durch einen Regler oben am Werkzeug einstellbar. Er verfügt über eine Werkzeugaufnahme aus gehärtetem Stahl. Die Abluft wird durch den Handgriff mittels 360° Rotationsprinzip nach hinten abgeführt. Der RUKO Druckluftschleifer verfügt über einen integrierten Luftfilter, der den Motor vor Verunreinigungen schützt, die mit der Druckluft ins Innere gelangen könnten. Die Werkzeugverlängerung ermöglicht das Arbeiten an engen, schwer zugänglichen und tief liegenden Stellen.



Anschlussadapter inklusive!

Verpackungseinheit: in Kartonverpackung

	L1 mm	Ø	Artikel-Nr.	
Druckluftschleifer (lang)	257,0	G 1/4"	116 130 L	1

Druckluftschleifer (kurz)
116 100 L

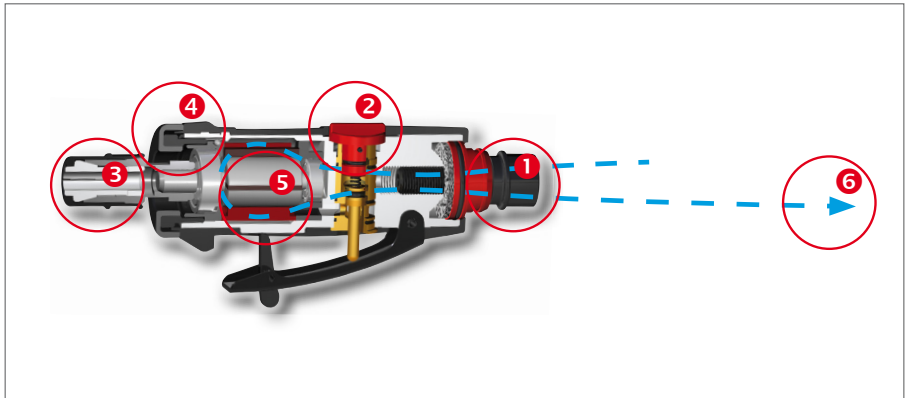

Druckluftschleifer (90°)
116 110 L

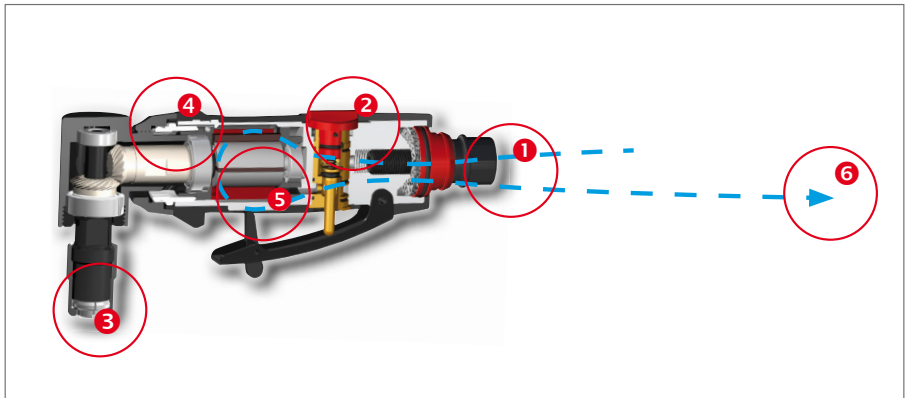

Druckluftschleifer (115°)
116 120 L

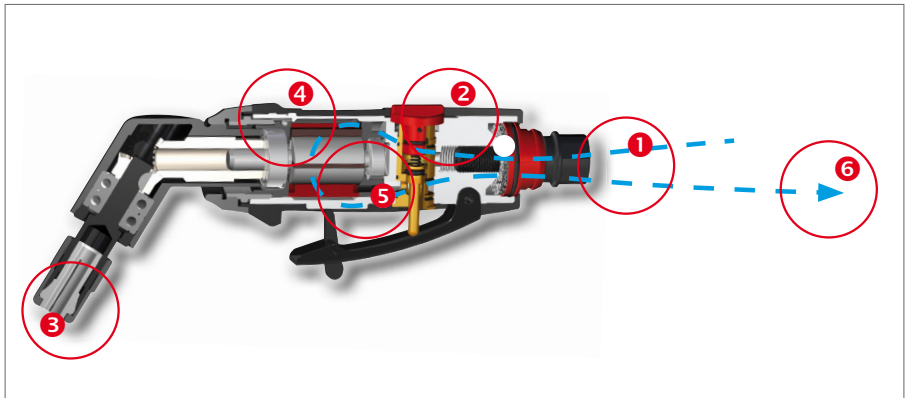

Druckluftschleifer (lang)
116 130 L

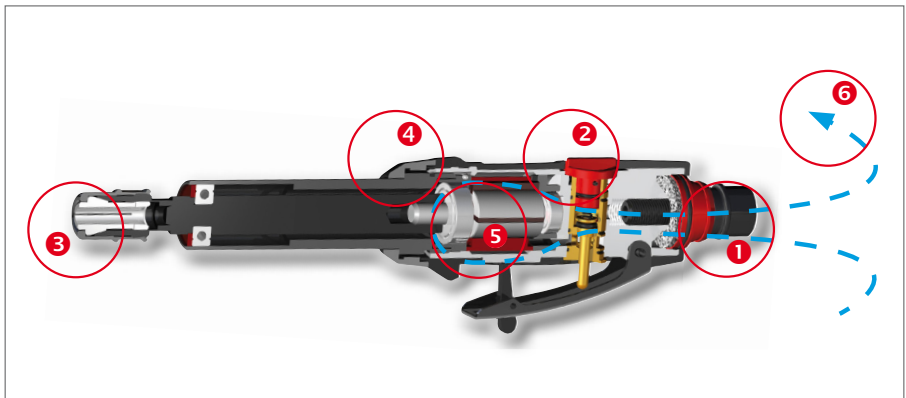

- ❶ Luftfilter
- ❷ Drehzahlregler
- ❸ Aufnahme aus gehärtetem Stahl
- ❹ Gummierter, rutschfester Handgriff
- ❺ Leistungsstarker Lamellenmotor
- ❻ Ablufführung durch den Handgriff mittels 360° Rotationsprinzip



Druckluftschleifer-Satz mit Kupplungsstecker inklusive Frässtifte-Satz im Kunststoffkoffer

	Artikel-Nr.
12-teiliger Druckluftschleifer-Satz 1 Druckluftschleifer + 10-tlg. Hartmetall-Frässtifte-Satz in Mini-Box je 1x Ø D1 6,0 + 12,0 mm 2 Frässtifte Form B, Zylinder (ZYAS) mit Stirnverzahnung 2 Frässtifte Form C, Walzenrund (WRC) 2 Frässtifte Form G, Spitzbogen (SPG) 2 Frässtifte Form F, Rundbogen (RBF) 2 Frässtifte Form D, Kugel (KUD) + Kupplungsstecker für Druckluftschleifer	116 100
5-teiliger Druckluftschleifer-Satz 1 Druckluftschleifer + 3-tlg. Hartmetall-Frässtifte-Satz in Mini-Box je 1x Ø 10,0 mm 1 Frässtift Form B, Zylinder (ZYAS) mit Stirnverzahnung 1 Frässtift Form G, Spitzbogen (SPG) 1 Frässtift Form D, Kugel (KUD) + Kupplungsstecker für Druckluftschleifer	116 113



116 100



116 113

Zubehör für Druckluftschleifer-Satz

Verpackungseinheit: einzeln in Kunststoffverpackung

	Artikel-Nr.
Druckluftschleifer 116 100 L + Kupplungsstecker 116 101 L	116 100 S
Ersatzrotor für Druckluftschleifer	116 100-1
Kupplungsstecker, Nennweite 7,2 mm mit Außengewinde G 1/4"	116 101 L
Spannzange 3,0 mm für Druckluftschleifer	116 121
Spannzange 1/4" für Druckluftschleifer	116 119



116 101 L

