

Schaltschränke

Schranksysteme

Anreih-Schranksystem VX25

Installations-Verteiler

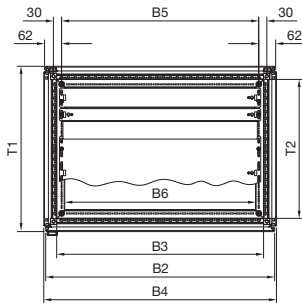
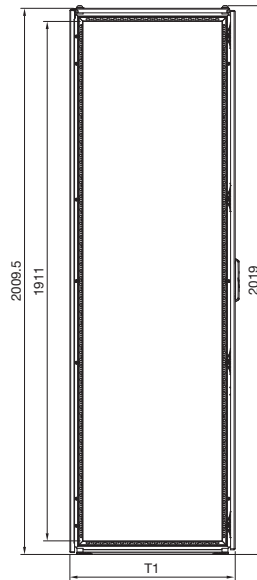
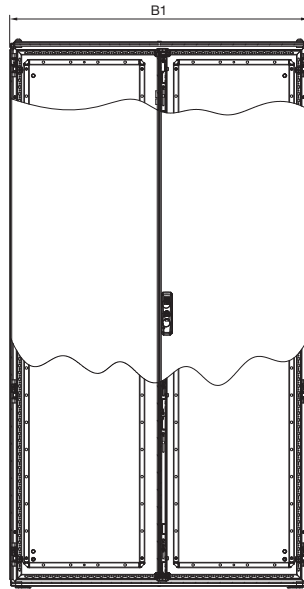
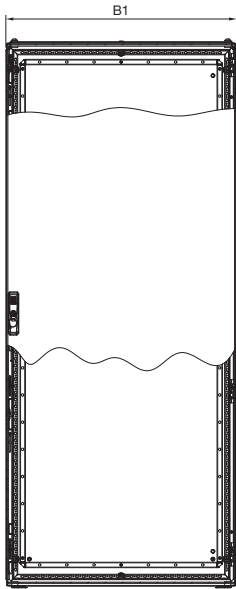

Profil

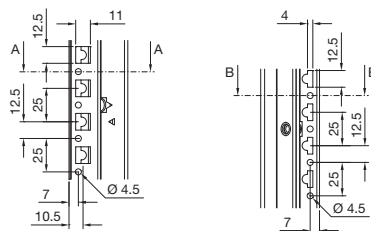

Schnitt A - A

Schnitt B - B

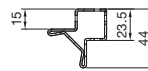
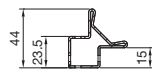

- B1 = Gesamtbreite
- B2 = Breite der Rückwand
- B3 = Lichtes Rahmeninnenmaß
- B4 = Breite mit Seitenwänden
- B5 = Lochabstand Boden-/Sockelbefestigung
- B6 = Lichtes Innenmaß Bodenöffnung
- T1 = Gesamttiefe mit Rück- und Seitenwand
- T2 = Lichtes Rahmeninnenmaß

Best.-Nr.	Breitenmaße mm						Tiefenmaße mm	
	B1	B2	B3	B4	B5	B6	T1	T2
9666.916	849	842	761	856	725	702	608	511
9666.926	1099	1092	1011	1106	975	952	608	511
9666.956	849	842	761	856	725	702	408	311
9666.966	1099	1092	1011	1106	975	952	408	311