

C30P/BP-2A

Kapazitive Sensoren



Micro Detectors

Italian Sensors Technology



Bilder rein Indikativ

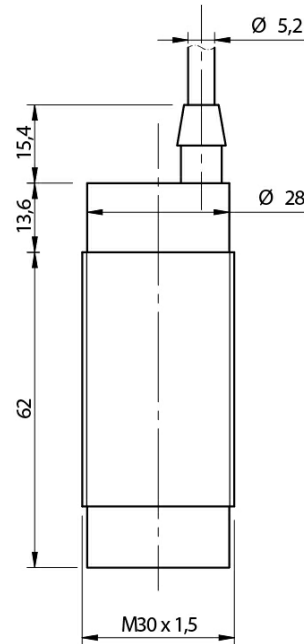

Detektionseigenschaften

Nominale Tastweite Sn	4...25mm
Temperaturdrift	< 20%
Wiederholgenauigkeit	5%
Empfindlichkeitseinstellung	Ja
Hysterese	≤ 20%

Ausgänge

Ausgangstyp	PNP
Ausgangsfunktion	NO + NC
Schaltfrequenz	30Hz

Elektrische Daten

Betriebsspannung	10...40Vdc
Leerlaufstrom	≤ 12mA
Laststrom	≤ 200mA
Leckstrom	≤ 100µA
Spannungsabfall im Ausgang	2,5Vmax @ IL=200mA
Maximale Restwelligkeit	≤10%
LED-Anzeigen	Gelbe LED (Objekt erfasst)

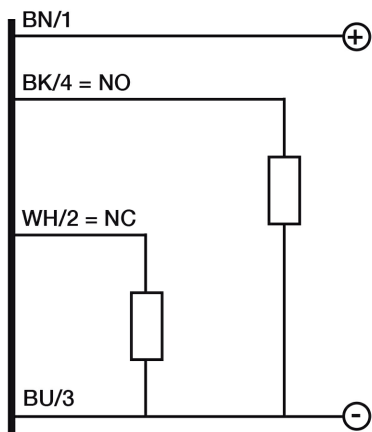

M.D.Micro Detectors S.p.A.

Strada S.Caterina, 235

41122 Modena (MO)

Tel. 059 420411

Fax 059 253973

E-mail info@microdetectors.com

Druckdatum

29/06/2020 16:25:14