

## LF40P

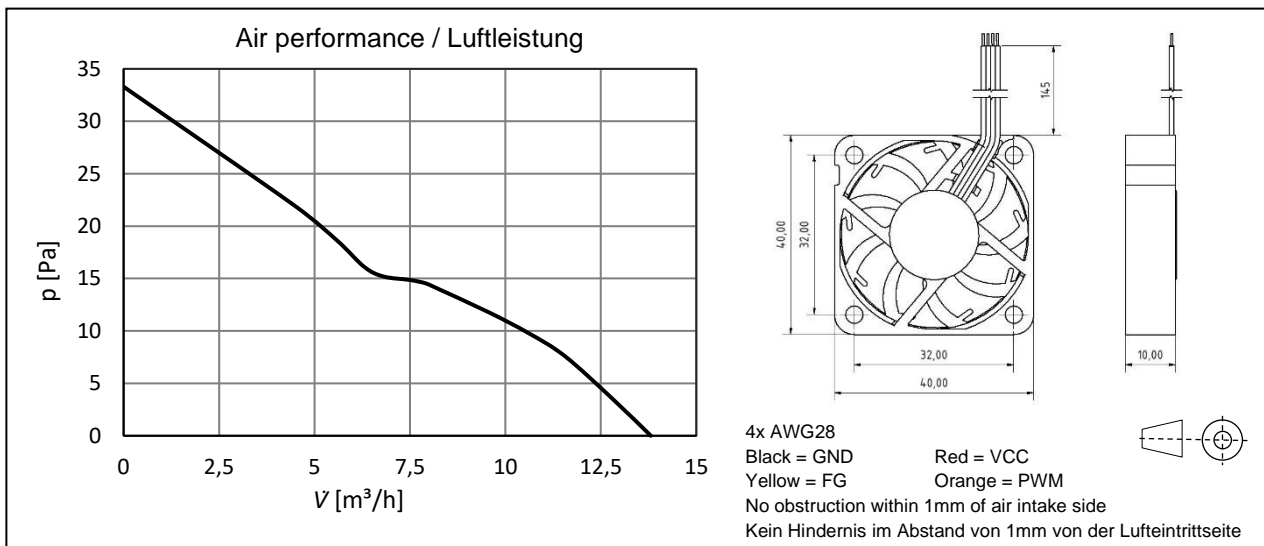

	<b>LF40P05PSE00A</b>	<b>LF40P12PSE00A</b>
Safety Approvals / Zertifizierungen	<b>CE</b>	<b>CE</b>
U [VDC]	4.5 ... 5 ... 5.5	10.8 ... 12 ... 13.2
I <sub>typ</sub> [mA]	100	50
I <sub>max</sub> [mA]	230	140
V <sub>max</sub> [l/min – m³/h]	230 – 13.8	
p <sub>max</sub> [Pa – mmH <sup>2</sup> O]	33 – 3.4	
Noise / Geräusch (typ.)* [dB(A)]	28	
RPM* [min <sup>-1</sup> ]	7500	
Signal / FG (...A) [pulses per revolution]	2	
PWM [VDC]	2.5 ... VCC	
Temp. [°C]	-20 ... +85	
Motor protection / Motorschutz	Impedance	
L10/MTTF @ 40°C [h]	40000/210000	
Bearing / Lagersystem	MagFix	
Weight / Gewicht [g]	12	

\* Noise and rotation speed are subject to deviations due to tolerance.  
 Geräusch und Drehzahl unterliegen toleranzbedingten Abweichungen.

### • ORDER INFORMATION / BESTELLDATEN

LF40P05PSE00A                      111111740  
 LF40P12PSE00A                      111111748

• Technical changes without notice      • 22.10.2020  
 • Technische Änderungen vorbehalten

## LF40P



### • FG / Tacho

**IMPORTANT:** The pulse output is not protected against short circuit and must not be connected to GND or VCC without series resistor. A pull-up-resistor is needed. Insulate not used pulse output!



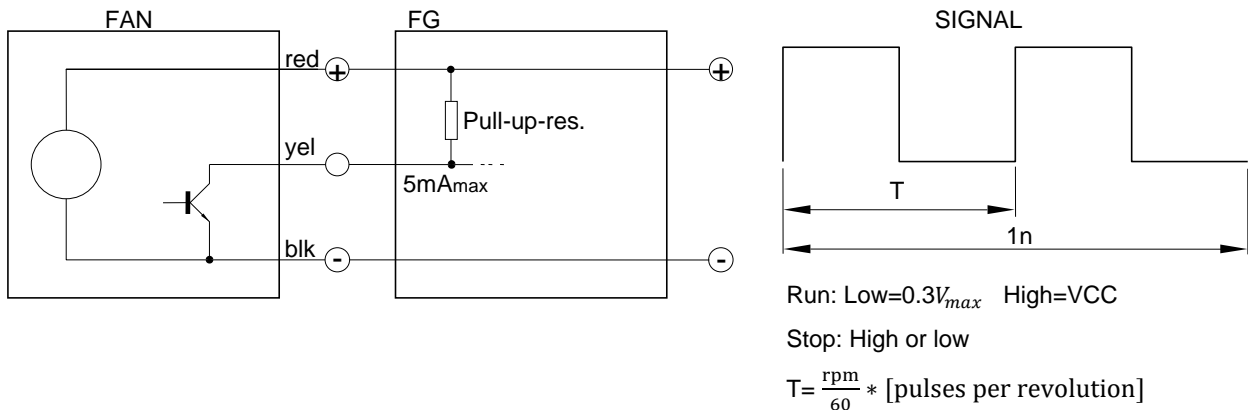

**Wichtig:** Der Tachoausgang ist nicht gegen Kurzschluss gesichert und darf ohne Vorwiderstand nicht an GND oder VCC angeschlossen werden. Ein Pull-up-Widerstand wird benötigt. Nicht benutzten Tachoausgang isolieren!



### • PWM

- Low=0 ... 0.7V<sub>max</sub> High=VCC
- f=23kHz
- Pulse width modulation / Pulsweitenverhältnis 30 ... 100%
- Startup duty cycle minimum 35%
- If fan power supply is off, do not input control signals into the PWM terminal!  
Keine PWM-Eingangsspannung erlaubt, wenn keine Betriebsspannung anliegt!

### • ACCESSORIES / ZUBEHÖR

				
	LFGFSB	FG	FM	LM
Cable assembly	Dust filter / Fan guard	Metal fan guard	EMC metal filter	Elastic fastening sleeves
Konfektionierung	Staubschutzfilter / Fingerschutzgitter	Fingerschutzgitter	EMV Filterrahmen	Lüftermanschette