

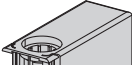





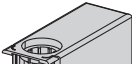

M6	6x		= LA9F701
	8x		= LA9F706
M8	6x		= LA9F702
	8x		= LA9F707
M10	6x		= LA9F703
	8x		= LA9F708
M12	6x		= LA9F704
	8x		= LA9F709

LA9 - F 701		
LC1 - FF 33 <u>LC1 - FF 43</u> CR1 - FF 33	LC1 - F 115	LR• - F 105 LR• - F 125
LA9 - F 702		
LC1 - FG 43 <u>CR1 - FG 33</u>	LC1 - F 150 LC1 - F 185	LR• - F 5 ...
LA9 - F 703		
LC1 - FH 33 LC1 - FH 43 LC1 - FJ 33 LC1 - FJ 42 LC1 - FJ 43 LC1 - FK 42 <u>LC1 - FK 43</u> CR1 - FH 33 CR1 - FJ 33 CR1 - FK 33	LC1 - F 225 LC1 - F 265 LC1 - F 330 LC1 - F 4002 LC1 - F 400 LC1 - F 5002 LC1 - F 500	LC1 - FJ 51 LC1 - FJ 52 LC1 - FJ 53 LC1 - FK 51 LC1 - FK 52 LC1 - FK 53 <u>LR• - F 6 ...</u> LR• - F 7 ...
LA9 - F 704		
LC1 - FL 42 LC1 - FL 43 <u>CR1 - FL 33</u>	LC1 - F 6302 LC1 - F 630	LC1 - FL 51 LC1 - FL 52 <u>LC1 - FL 53</u> LR• - F 8 ...
LA9 - F 706		
LC1 - FF 34 <u>LC1 - FF 44</u> CR1 - FF 34	LC1 - F 1154	
LA9 - F 707		
LC1 - FG 34 <u>LC1 - FG 44</u> CR1 - FG 34	LC1 - F 1504 LC1 - F 1854	
LA9 - F 708		
LC1 - FH 34 LC1 - FH 44 LC1 - FJ 34 LC1 - FJ 44 LC1 - FK 34 <u>LC1 - FK 44</u> CR1 - FH 34 CR1 - FJ 34 CR1 - FK 34	LC1 - F 2254 LC1 - F 2654 LC1 - F 3304 LC1 - F 4004 LC1 - F 5004	LC1 - FJ 54 LC1 - FK 54
LA9 - F 709		
LC1 - FL 34 <u>LC1 - FL 44</u> CR1 - FL 34	LC1 - F 6304	LC1 - FL 54

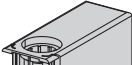
M10*
M12

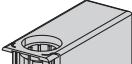

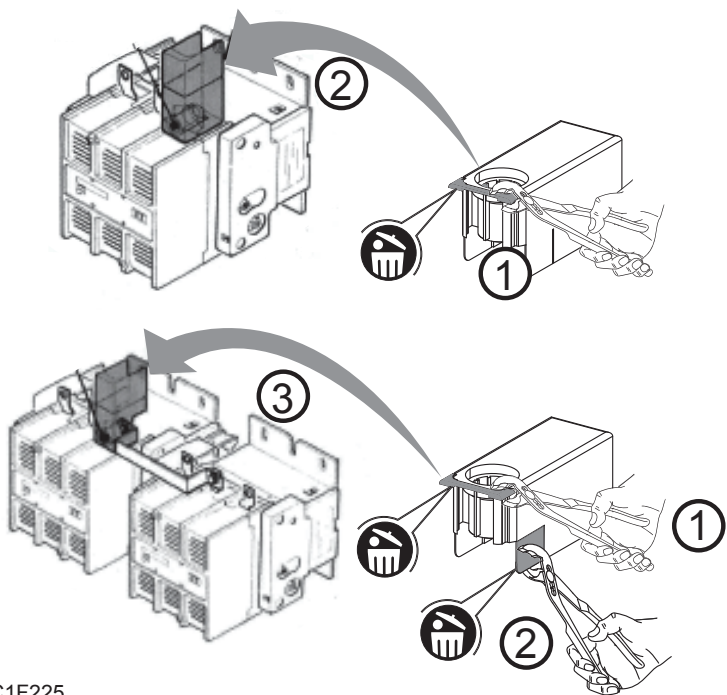
* Except LC1F225

M10 + LC1F225

