



Hauptmerkmale

Baureihe	Harmony Zeitrelais
Produkt- oder Komponententyp	Multifunktionsrelais
Diskreter Ausgangstyp	Relais
Breite	17,5 mm
Kurzbezeichnung des Geräts	RE17R
Zeitverzögerungsfunktion	Einschaltverzögerung Einschaltverzögerung und Ausschaltverzögerung Intervall Zeitverzögerung bei fallender Flanke (OFF delay) Symmetrisches Blinken
Zeitverzögerungsbereich	6 - 60 min 1 - 10 h 0,1 - 1 s 1 - 10 s 1 - 10 min 10 - 100 h 6 - 60 s
Nennausgangsstrom	8 A

Zusatzmerkmale

Art und Zusammensetzung der Kontakte	1 Wechslerkontakt
Kontaktmaterial	Cadmiumfrei
Höhe	90 mm
Tiefe	72 mm
Betätigungsart	Wahlschalter Frontplatte
[UH,nom] Bemessungsbetriebsspannung	24 - 240 V AC 50/60 Hz 24 V DC
Spannungsbereich	0,85 - 1,1 Us
Netzfrequenz	50 - 60 Hz +/- 5 %
Auslösung der Eingangsspannung	10 V
Anschlüsse - Klemmen	Federklemmen, 2 x 0,2 - 1,5 mm ² (AWG 24 - AWG 16) starr ohne Kabelende Federklemmen, 2 x 0,2 - 1,5 mm ² (AWG 24 - AWG 16) flexibel ohne Kabelende
Gehäusematerial	Selbstlöschend
Wiederholgenauigkeit	+/-0,5 % entspricht IEC 61812-1
Temperaturabweichung	+/- 0,05 %/°C
Spannungsdrift	+/-0,2 %/V
Einstellgenauigkeit der Zeitverzögerung	+/- 10 % der Gesamtskala bei 25°C entspricht IEC 61812-1
Breite des Steuersignalimpulses	100 ms mit Last parallel geschaltet typisch 30 ms typisch
Isolationswiderstand	100 MOhm bei 500 V DC entspricht IEC 60664-1
Rückstellzeit	120 ms bei Abschaltung typisch
Lastfaktor	100 %
Leistungsaufnahme in VA	0...32 VA bei 240 V AC
Leistungsaufnahme in W	0,6 W bei 24 V DC
Min. Schaltstrom	10 mA bei 5 V DC
Maximaler Schaltstrom	8 A AC/DC
Maximale Schaltspannung	250 V AC
Ausschaltvermögen	2000 VA

Betriebsfrequenz	10 Hz
Elektrische Lebensdauer	100000 Zyklen (8 A bei 250 V AC maximal) für ohmsch Belastung
Mechanische Lebensdauer	10000000 Zyklen
Spannungsfestigkeit	2,5 kV 1 mA/1 Minute 50 Hz entspricht IEC 61812-1
Bemessungsstoßspannungsfestigkeit [Uimp]	5 kV während 1,2/50 µs
Einschaltverzögerung	100 ms
Beschriftung	CE
Kriechstrecke	4 kV/3 entspricht IEC 60664-1
Daten bezüglich Sicherheit und Zuverlässigkeit	B10d = 270.000 MTTFd = 296,8 Jahre
Einbauposition	Jede Position bezogen auf senkrechte Montageplatte
Montagehalterung	35 mm DIN-Schiene entspricht EN/IEC 60715
Lokale Signalisierung	LED-Anzeige für Dauersignal: Relais aktiv, keine Zeitsteuerung läuft LED-Anzeige für Blinkend: Zeitsteuerung läuft 80 % AN und 20 % AUS LED-Anzeige für Pulsierend: Relais abgeschaltet, kein Zeitfunktion aktiv (ausgenommen Di-D, Li-L) 5 % AN und 95 % AUS
Produktgewicht	0,06 kg
Zeitverzögerungstyp	A, Ac, At, B, Bw, C, D, Di, H, Ht
Funktionalität	Mehrfachfunktion
Kompatibilitätscode	RE17

Montage

Störfestigkeit gegen Unterbrechungen	20 ms
Normen	2006/95/EC 2004/108/EC IEC 61812-1 EN 61000-6-2 EN 61000-6-3 EN 61000-6-4 EN 61000-6-1
Produktzertifizierungen	CSA[RETURN]cULus[RETURN]DNV-GL[RETURN]EAC[RETURN]CCC
Umgebungstemperatur bei Lagerung	-30...60 °C
Umgebungstemperatur bei Betrieb	-20...60 °C
Schutzart (IP)	IP20 (Klemmenleiste) entspricht IEC 60529 IP40 (Gehäuse) entspricht IEC 60529 IP50 (Frontplatte) entspricht IEC 60529
Vibrationsfestigkeit	20 m/s ² (f= 10...150 Hz) entspricht IEC 60068-2-6
Stoßfestigkeit	15 gn für 11 ms entspricht IEC 60068-2-27
Relative Feuchtigkeit	93 % ohne Kondensation entspricht IEC 60068-2-30
Elektromagnetische Verträglichkeit	Störfestigkeitsprüfung bei elektrostatischer Entladung: (in Kontakt), Level 3, 6 kV, entspricht IEC 61000-4-2 Störfestigkeitsprüfung bei elektrostatischer Entladung: (in der Luft), Level 3, 8 kV, entspricht IEC 61000-4-2 Suszeptibilität gegen elektromagnetische Felder: (80 MHz - 1 GHz), Level 3, 10 V/m, entspricht IEC 61000-4-3 Elektrische Funkentstörfestigkeitsprüfung: (kapazitiver Verbindungsverschluss), Level 3, 1 kV, entspricht IEC 61000-4-4 Elektrische Funkentstörfestigkeitsprüfung: (direkt), Level 3, 2 kV, entspricht IEC 61000-4-4 1,2/50 µs Schockwellen-Störfestigkeitsprüfung: (Differentialbetrieb), Level 3, 1 kV, entspricht IEC 61000-4-5 1,2/50 µs Schockwellen-Störfestigkeitsprüfung: (Gleichtakt), Level 3, 2 kV, entspricht IEC 61000-4-5 Leitungsgebundene HF-Störungen: (0,15 - 80 MHz), Level 3, 10 V, entspricht IEC 61000-4-6 Prüfung der Störfestigkeit gegen Spannungseinbrüche und Unterbrechungen: (1 Zyklus), 0 %, entspricht IEC 61000-4-11 Prüfung der Störfestigkeit gegen Spannungseinbrüche und Unterbrechungen: (25/30 Zyklen), 70 %, entspricht IEC 61000-4-11 Leitungsgebundene und abgestrahlte Emissionen: , Klasse B, entspricht EN 55022

Verpackungseinheiten

VPE 1 Art	PCE
VPE 1 Menge	1
VPE 1 Höhe	2,8 cm
VPE 1 Breite	7,5 cm
VPE 1 Länge	9,5 cm
VPE 1 Gewicht	70,0 g
VPE 2 Art	S02
VPE 2 Menge	40
VPE 2 Höhe	15,0 cm
VPE 2 Breite	30,0 cm
VPE 2 Länge	40,0 cm
VPE 2 Gewicht	3,408 kg

Nachhaltigkeit

Angebotsstatus nachhaltiges Produkt	Green Premium Produkt
REACH-Verordnung	REACH-Deklaration
EU-RoHS-Richtlinie	Übererfüllung der Konformität (außerhalb EU RoHS-Scope)
Quecksilberfrei	Ja
RoHS-Richtlinie für China	RoHS-Erklärung Für China
Informationen zu RoHS-Ausnahmen	Ja
Umweltproduktdeklaration	Produktumweltprofil
Kreislaufwirtschafts-Profil	Entsorgungsinformationen
WEEE	Das Produkt muss entsprechend bestimmter Hinweise auf Märkten der Europäischen Union entsorgt werden und darf nicht in Haushaltsabfälle gelangen.

Vertragliche Gewährleistung

Garantie	18 Monate
----------	-----------

Dimensions

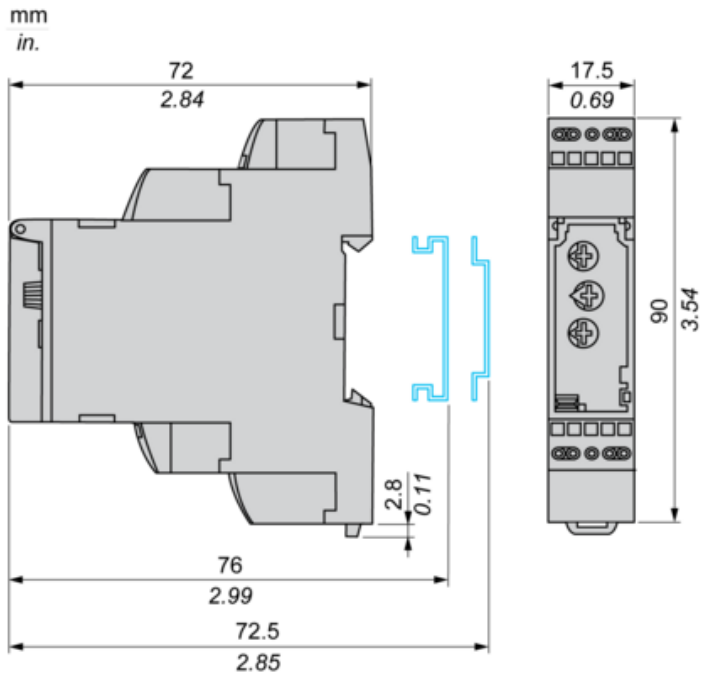

Internal Wiring Diagram

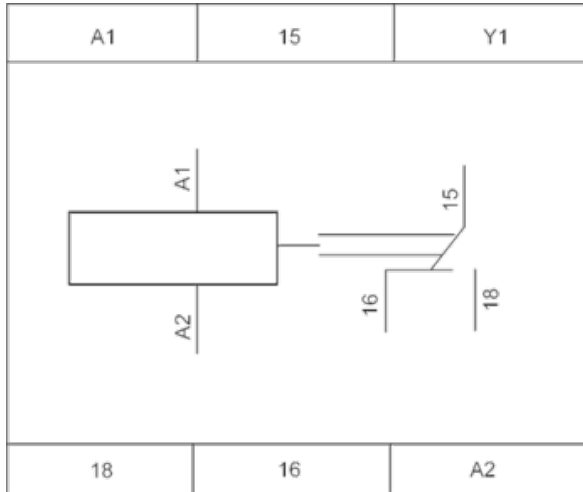

Wiring Diagram

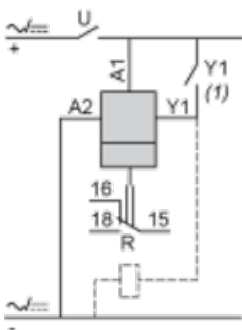

1) Contact Y1:

- Control for functions B, C, Ac, Bw, Ad, Ah, N, O, W, T, Tt.
- Partial stop for functions At, Ht and Pt.
- Function D if Di selected.
- Not used for functions A, H and P.

Function A : Power on Delay Relay

Description

The timing period T begins on energisation. After timing, the output(s) R close(s). The second output can be either timed or instantaneous.

Function: 1 Output



Function: 2 Outputs

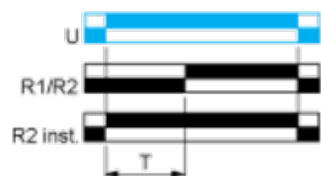

2 timed outputs (R1/R2) or 1 timed output (R1) and 1 instantaneous output (R2 inst.)

Function Ac: On-Delay & Off-Delay with Control Signal

Description

After energisation of power supply and energization of Y1 causes the timing period T to start.

At the end of this timing period, the output(s) R close(s).

When deenergization of Y1, the timing T starts.

At the end of this timing period T, the output(s) R revert(s) to its/their initial position.

The second output (R2) can be either timed (when set to "TIMED") or instantaneous (when set to "INST").

Function: 1 Output

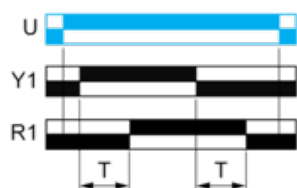

Function: 2 Outputs

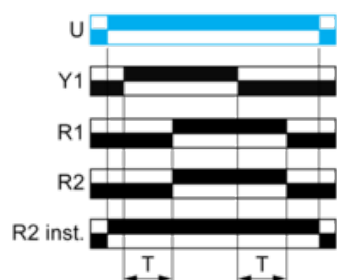

Function At : Power on Delay Relay (Summation) with Control Signal

Description

After power-up, the first opening of control contact C starts the timing. Timing can be interrupted each time control contact closes. When the cumulative total of time periods elapsed reaches the pre-set value T, the output relay closes.

Function: 1 Output

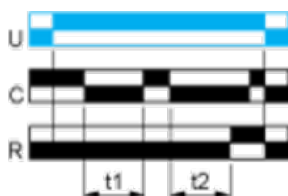

$$T = t1 + t2 + \dots$$

Function B : Interval Relay with Control Signal

Description

After power-up, pulsing or maintaining control contact C starts the timing T. The output R closes for the duration of the timing period T then reverts to its initial state.

Function: 1 Output

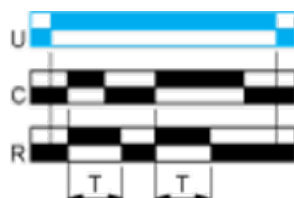

Function Bw : Double Interval Relay with Control Signal

Description

On closing and opening of control contact C, the output R closes for the duration of the timing period T.

Function: 1 Output



Function C : Off-Delay Relay with Control Signal

Description

After power-up and closing of the control contact C, the output R closes. When control contact C re-opens, timing T starts. At the end of the timing period, the output(s) R revert(s) to its/their initial state. The second output can be either timed or instantaneous.

Function: 1 Output

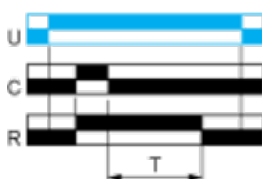

Function: 2 Outputs

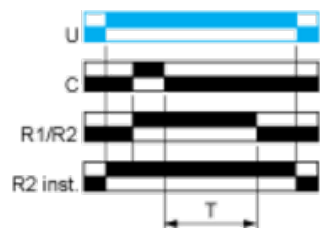

2 timed outputs (R1/R2) or 1 timed output (R1) and 1 instantaneous output (R2 inst.)

Function D: Symmetrical Flashing Relay (Starting Pulse Off)

Description

On energisation of power supply, output(s) R starts at its/their initial state for timing duration T then change(s) to output(s) R close(s) for the same timing duration T. This cycle is repeated indefinitely until power supply removal. Specially for RE17*, RE22R2AMU, RE22R2MMW, RE22R2MMU, RE22R2MJU, this D function can only be initiated by energizing Y1 permanently. The second output (R2) can be either timed (when set to "TIMED") or instantaneous (when set to "INST").

Function: 1 Output

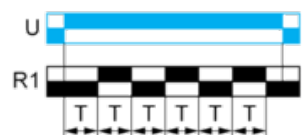

Function: 2 Outputs

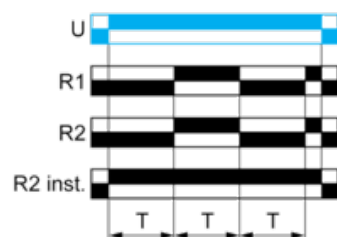

Function: 1 Output with Retrigger / Restart Control

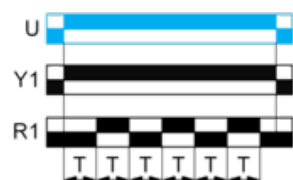

Function: 2 Output with Retrigger / Restart Control

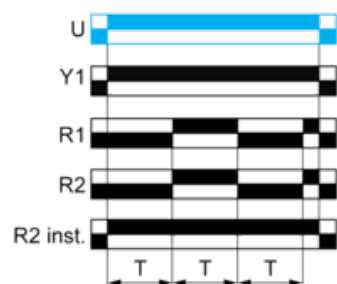

Function Di : Symmetrical Flasher Relay (Starting Pulse On)

Description

Repetitive cycle with two timing periods T of equal duration, with output(s) R changing state at the end of each timing period T. The second output can be either timed or instantaneous.

Function: 1 Output



Function: 2 Outputs

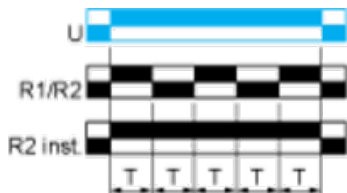

2 timed outputs (R1/R2) or 1 timed output (R1) and 1 instantaneous output (R2 inst.)

Function H : Interval Relay

Description

On energisation of the relay, timing period T starts and the output(s) R close(s). At the end of the timing period T, the output(s) R revert(s) to its/their initial state. The second output can be either timed or instantaneous.

Function: 1 Output



Function: 2 Outputs

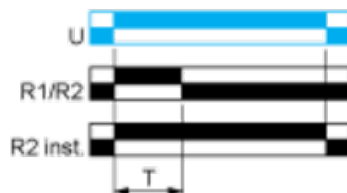

2 timed outputs (R1/R2) or 1 timed output (R1) and 1 instantaneous output (R2 inst.)

Function Ht: Interval Relay & With Pause / Summation Control

Description

On energisation of power supply, output(s) R close(s) and timing period T starts.

The timing can be interrupted / paused each time X1 energizes.

When the cumulative total of time periods elapsed reaches the pre-set value T, the output(s) R revert(s) to its/their initial state. Reenergization of X1 will also cause output(s) R close(s) if the time has elapsed and restart the same operation as described at the beginning.

Except for RE17*, RE22R2MMW, RENF22R2MMW, RE22R2MMU and RE22R2MJU, timing can be interrupted / paused each time Y1 energizes.

The second output (R2) can be either timed (when set to "TIMED" or instantaneous (when set to "INST").

Function: 1 Output

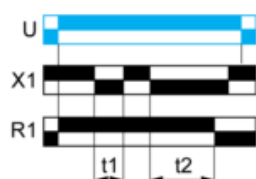

$T = t1 + t2 + \dots$

Function: 2 Outputs

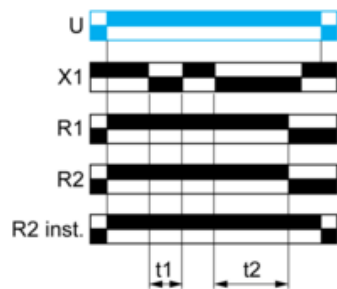

$T = t_1 + t_2 + \dots$

Function: 1 Output with Retrigger / Restart Control

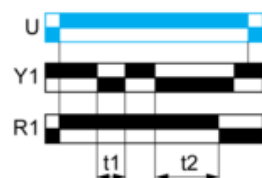

$T = t_1 + t_2 + \dots$

Function: 2 Outputs with Retrigger / Restart Control

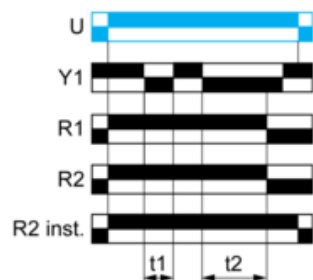

$T = t_1 + t_2 + \dots$

Legend

Relay de-energised

Relay energised

Output open

Output closed

C	Control contact
G	Gate
R	Relay or solid state output
R1/R2	2 timed outputs
R2 inst.	The second output is instantaneous if the right position is selected
T	Timing period
Ta -	Adjustable On-delay
Tr -	Adjustable Off-delay
U	Supply