

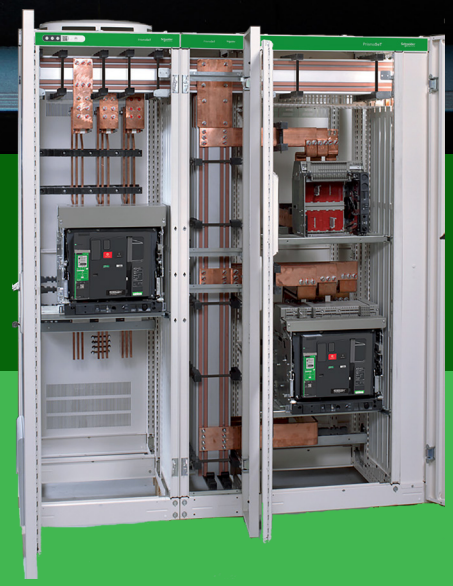

PrismaSeT P4000 Active

Catalogue 2021
Cubicles up to 4000 A



se.com

Life Is On | **Schneider**
Electric



Content PrismaSeT

Index
p. A-1

Catalogue number index
> p. A-1

Presentation
p. B-1

**PrismaSeT P4000 Active -
Reliable, Easily Connected**
> p. B-2

**Communication
Architecture**
> p. B-6

**HeatTag - Early Detection
of overheating Cables**
> p. B-11

Architecture
p. C-1

**Functional units Connection -
Device installation and distribution**
> p. C-2

**Horizontal busbars - Linergy LGYE
profile or Linergy BS busbars**
> p. C-3

Characteristics
p. D-1

**Electrical characteristics
Determining the busbars**
> p. D-2

P4000 Active

Index
p. A-1

A

**P4000 Switchboard
Presentation**
> p. B-12

**P4000 Switchboard
Characteristics**
> p. B-13

Cubicle configuration
> p. B-14

Presentation
p. B-1

B

**Enclosures
IP30 enclosures**
> p. C-5

IP31 enclosures
> p. C-6

IP55 enclosures
> p. C-7

Architecture
p. C-1

C

Characteristics
p. D-1

D

Catalogue number index with designations

Com. no.	Designation	Page
3000		
LVS03500	Mounting plate for NW	C-2
LVS03710	Front plate for withdrawable NW	0-0
LVS03710	Front plate for fixed NW	C-2
LVS03803	Plain front plate, 3 modules	C-2
LVS03804	Plain front plate, 4 modules	C-2
LVS03895	IP30 ventilated front plate, 3 modules	C-2
4000		
LVS04552	Horizontal flat bar Linergy BS 120 x 10 L2000	C-3
LVS04568	Linergy LGYE profile 4000 A L2000	C-3
LVS04607	Linergy LGYE vertical connection 4000A	C-3
LVS04623	Linergy LGYE horizontal connection 4000A	C-3
LVS04624	Isolating screen neutral Linergy LGYE	C-3
LVS04638	4000 A connection 10 mm horizontal busbar with Linergy BS vertical flat bar	C-3
LVS04643	Joint for 120 mm bar for Linergy BS horizontal busbar	C-3
LVS04644	4000 A conn.PAD	C-2
LVS04646	12 spacers 150 mm for Linergy LGYE profile	C-2, C-3
LVS04662	Free 5/10 mm busbars support Linergy LGYE/BS	C-2, C-3
LVS04664	Horizontal 5/10 mm busbar support Linergy LGYE/BS	C-2, C-3
LVS04671	Support mounting hardware for bars > 80 mm	C-2, C-3
LVS04678	Free 5/10 mm busbar support D600 Linergy BS	C-2
LVS04694	Connection support, 115 mm between centres	C-2
LVS04737	Canalis connection, 4000 A, NW, 3P	C-2
LVS04738	Canalis connection, 4000 A, NW, 4P	C-2
LVS04915	Plain barrier for horizontal busbars W400 D400	C-4
LVS04919	Plain barrier for horizontal busbars W800 D400	C-4
LVS04963	Form 2 cover for horizontal busbars, W = 300 mm, D = 600 mm, 4000 A	C-4
LVS04964	Form 2 cover for horizontal busbars, W = 400 mm, D = 600 mm, 4000 A	C-4
LVS04966	Form 2 cover for horizontal busbars, W = 650 mm, D = 600 mm, 4000 A	C-4
LVS04968	Form 2 cover for horizontal busbars, W = 800 mm, D = 600 mm, 4000 A	C-4
8000		
LVS08406	Framework, W = 650 mm, D = 400 mm	C-5, C-6, C-7
LVS08436	IP30 plain roof, W = 650 mm, D = 400 mm	C-5, C-6
LVS08456	IP55 plain roof, W = 650 mm, D = 400 mm	C-7
LVS08516	IP30 plain door, W = 650 mm	C-5, C-6
LVS08526	IP55 plain door, W = 650 mm	C-7
LVS08566	Hinged front plate support frame, W = 650 mm	C-5, C-6, C-7
LVS08576	IP30 cover frame, W = 650 mm	0-0
LVS08606	Framework, W = 650 mm, D = 600 mm	C-5, C-6, C-7
LVS08656	IP55 plain roof, W = 650 mm, D = 600 mm	C-7
LVS08676	IP30 ventilated roof, W = 650 mm, D = 600 mm	C-5, C-6

Com. no.	Designation	Page
LVS08711	IP31 sealing kit	C-6
LVS08736	IP30 rear panel, W = 650 mm	C-5, C-6
LVS08746	IP55 rear panel, W = 650 mm	C-7
LVS08750	2 IP30 side panels , W = 400 mm	C-5, C-6
LVS08755	2 IP55 side panels , W = 400 mm	C-7
LVS08760	2 IP30 side panels , W = 600 mm	C-5, C-6
LVS08765	2 IP55 side panels , W = 600 mm	C-7
LVS08990	Filters, 5 fine	C-7
NSY		
NSYCVF850M230PF	IP55 230 V front or side fan	C-7
NSYCVF850M400PF	IP55 400 V front or side fan	C-7

A

Presentation

Contents

General presentation

PrismaSeT P4000 Active - Reliable, Easily connected	B-2
Communication Architecture	B-6
HeatTag Early detection of Overheating Cables	B11
General Presentation	B-12
Characteristics	B-13
Cubicle Configuration	B-14

B

PrismaSeT P4000 Active - Reliable, Easily connected

The new PrismaSeT P Active switchboard is the market forerunner with built-in cloud connectivity, allowing instant access to smart alarm system, energy usage analysis, trends, and preventative maintenance plans. Built-in cloud connectivity allows users to be notified of the round-the-clock electrical distribution as well as voltage loss if any. This maximizes efficiency and power availability, while creating the basis for future innovations. The PrismaSeT P Active switchboard also allows easy wireless integration of sensors.

Offer values

-  **Simplicity**
 - Deliver connectivity without any complexity
-  **Easy installation**
 - Simple-to-install connected solution
-  **Robustness and Design**
 - New design with new structure color, increased frame and door robustness
-  **Win more business**
 - Increase the service business opportunities while offering an affordable connected panel
-  **Protection**
 - Deliver greater peace of mind

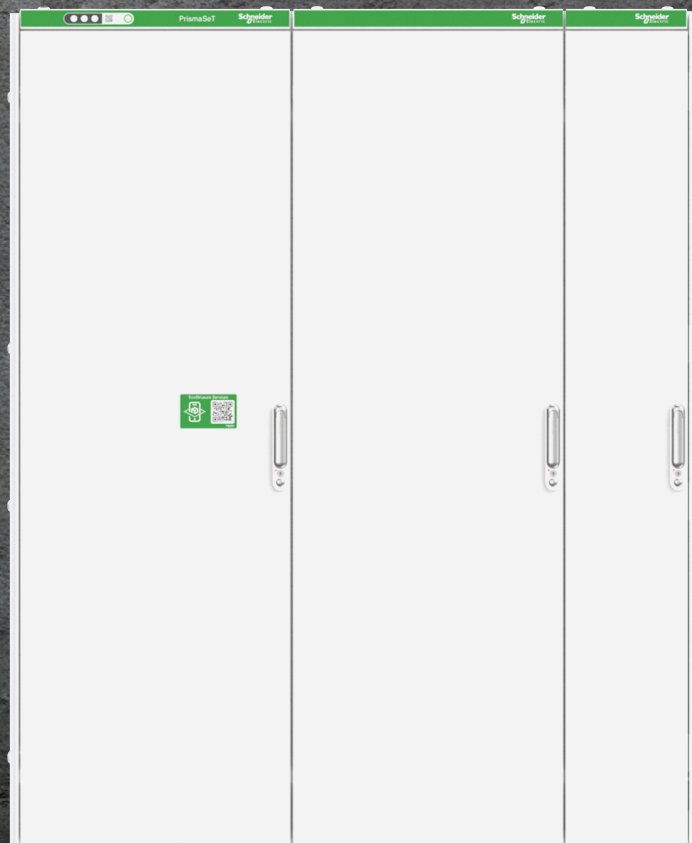

Digital journey

Peace of mind on the Cloud

- Electrical Fire Prevention
- Power availability at no cost
- Energy awareness



Easy-to-install 100% wireless communication solutions

- User friendly installation instructions
- Independent from customer IT

Built-in connectivity

- Voltage loss alert free of charge
- Connection to cloud in less than 5 min without any IT skill

Easy installation and commissioning

- Less than 30 minutes for setting up the communication devices

PrismaSeT P4000 Active - Reliable, Easily connected

New design with sustainable packaging

Enhance buildings with in-built connectivity and efficient design

The new design of PrismaSeT P Active increases the robustness of the panels, helps to gain efficiency on every level and provides peace of mind to the panel builders, electrical contractors and facility managers.

In addition, the new 100% green packaging decreases the quantity of waste and its disposal cost by using only cartons.

Green Packaging

- Progressive cancellation of plastic and polystyrene of packaging.
- 100% recyclable cardboards.
- Time & money saving to sort waste.
- New cross beam in cardboard for a more robust packaging.

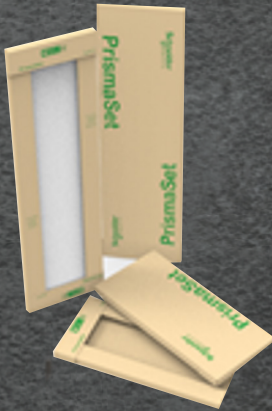

New Improved Handle

- More robust handle.
- Keyless entry door.
- Ergonomic and Aesthetically handle design.



Reinforced Frame

- Easier transportation and perception during assembly.
- Reinforcement on the lower angle levels using additional accessories.

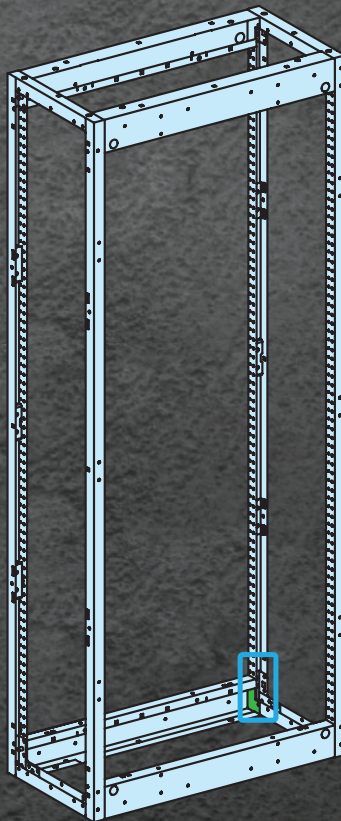

Reinforced Plain Door

- 3 hinges
- Sheet metal thickness 1.5 mm
- 20 x 20 bar reinforcement

IP 30/31 Plain Door

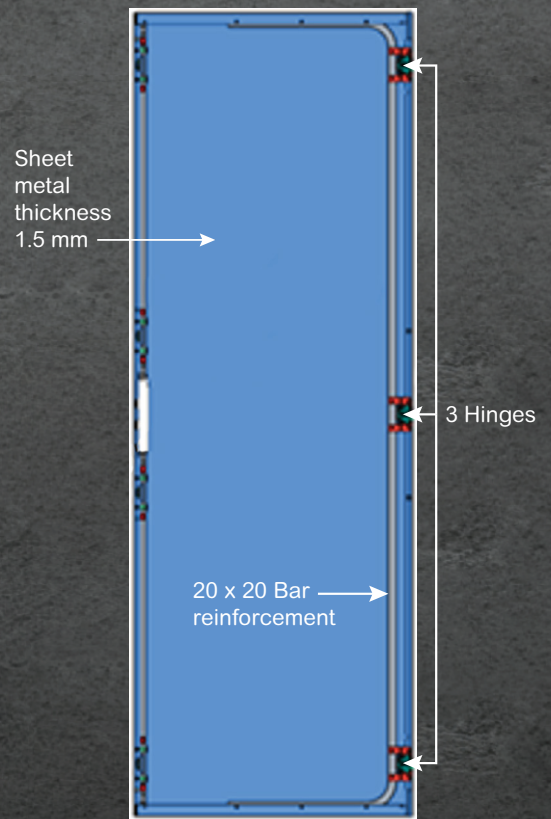

B

Digital Instruction Sheets

- Cancellation of systematic printed instruction in each packaging.
- 1 printed 'Super Leaflet' with all instructions (available to order once).
- 1 systematic QR code to link to the right instruction sheets.

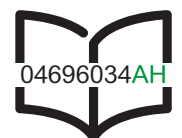

EcoStruxure™ Facility Expert

Cloud software to improve operations efficiency



Mobility to improve maintenance & operations

Register easily and overview all your assets status

QR code ready, Schneider Electric devices are already configured to communicate with EcoStruxure™ Facility Expert in a simple way and enable automatic download of ID, technical documentation and maintenance plan.

Located on the map, visualize all assets in real time, navigate and filter by area or status.

Remain connected and Informed

Providing relevant information on critical assets, sending instant and documented alarms EcoStruxure™ Facility Expert allows to diagnose remotely in case of issue and to manage maintenance efficiently.

- Instant alarms on threshold and status change
- Real-time assets status and map localization.
- Maintenance plan, asset log history, asset doc repository.
- Task manager and task reminder.
- 1 click to edit intervention and activity reports including voice memos, notes, photos and measurements.
- Remain connected, comment, share information and get support in the field from colleagues or experts if needed.



Web-application to monitor & analyze energy

EcoStruxure™ Facility Expert energy features give insights into energy data and provide visibility to reduce energy consumption.

On their web portal, Facility Managers get a clear vision on real time energy consumption for all managed buildings from any location.

- Main energy consumptions tracking (main, usage, zone, meter)
- Multi-site comparison capacity
- Cost monitoring
- Power demand and power factor monitoring
- Building performance: benchmarking against local energy performance scale (regulatory compliance to ISO50001, LEED, NABERS)
- Monthly score cards
- **Energy kiosk:** displayed on building public TV screens, this option shows your green image to visitors and promotes occupant ecofriendly behaviours.

Schneider Electric partners network

Schneider Electric local partners are trained and certified to sell, install and commission EcoStruxure™ Facility Expert. They can also operate the solution if the site manager wants to delegate this task.

PrismaSeT P4000 Active - Presentation

For Commercial and Industrial application



- 1 Built-in wireless panel server
 - 2 LED indicators: Phase status (on/off)
 - 3 QR Code to activate your free alerts
 - 4 EcoStruxure™ Facility Expert communication status indicator
- Service is activated on cloud-based software
 - Service is not activated (blinking)



EcoStructure™ Facility Expert

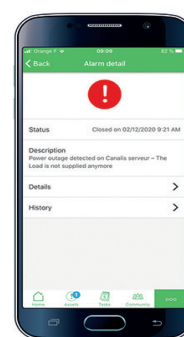

Alert detail

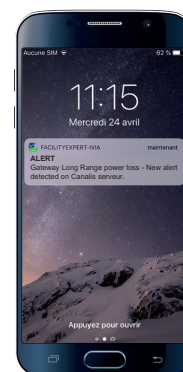

24/7 notifications on mobile devices

Note: The voltage presence indication of the Wireless Panel Server is only indicative and cannot replace all safety measures required before any intervention into the Low Voltage Switchboard



PrismaSeT Active wireless panel server installed into its environment.

Communication Architecture

General Principle

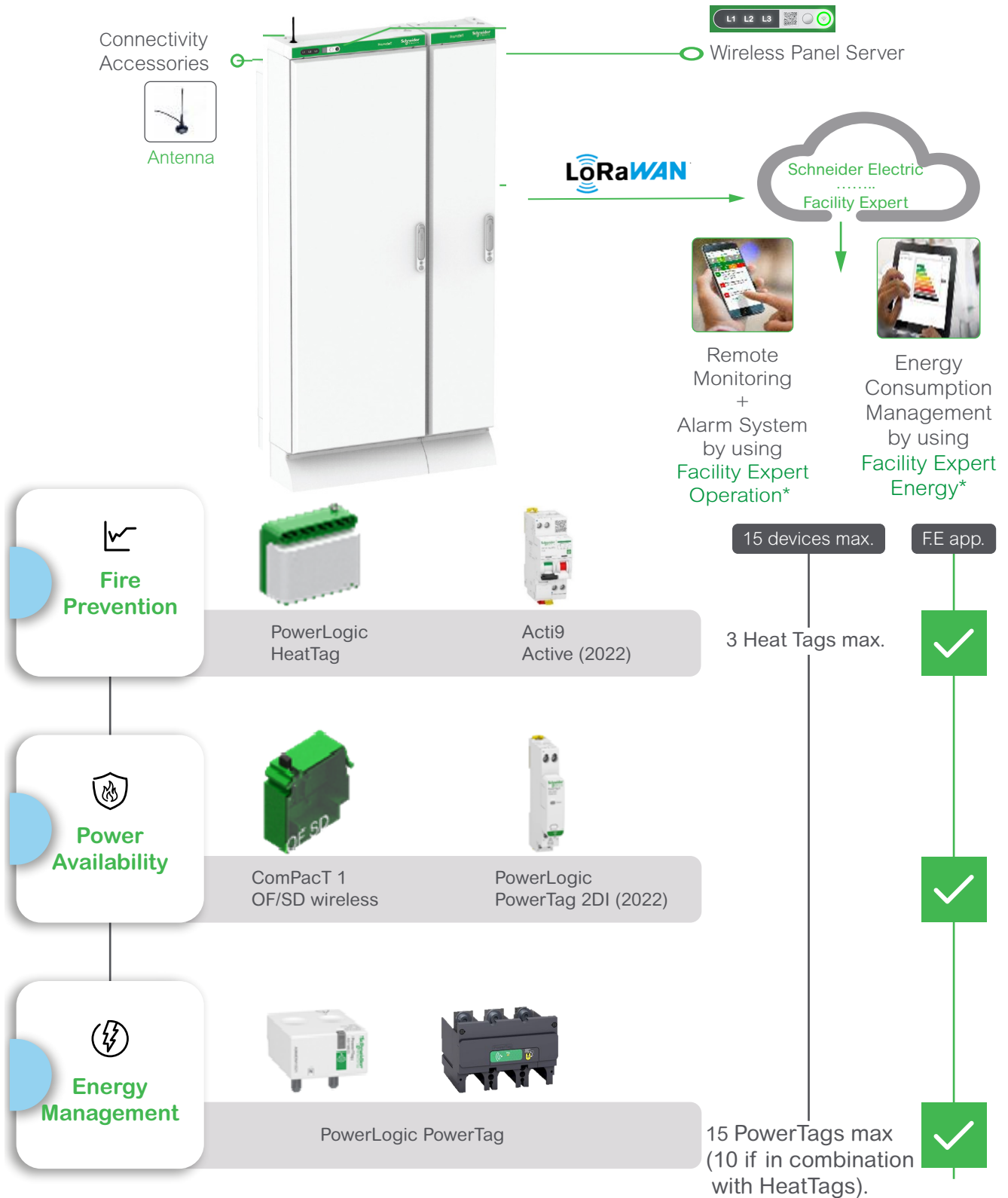

***Facility Expert Energy:**

It is a Cloud software for energy efficiency. The app generates alarms when the consumption exceeds set targets while monitoring the energy consumption 24/7 with comparison by site or usage.

***Facility Expert Operation:**

It is a cloud software for operation efficiency that alerts the user to optimize the maintenance procedures.

Communication Architecture

Main Features

LoRaWAN (Long Range Wide Area Network) is a networking protocol designed to connect wirelessly in order to assure end-to-end communication services.

The followings are the differentiating factors compared to other networking protocols:

- Long range coverage
- Low energy consumption
- Better penetration in buildings
- No SIM needed
- No additional fees to pay (included in Facility Expert subscription).

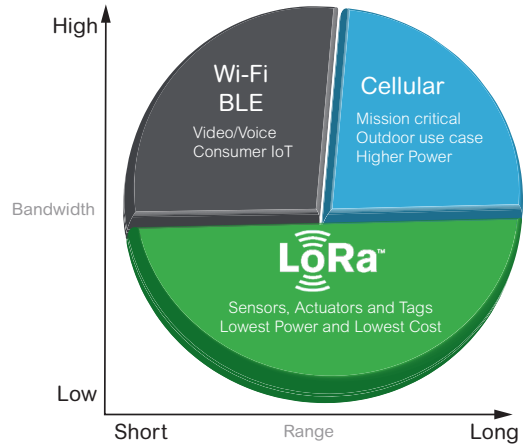

B



Simple 3-wire cable connections for ease of connectivity to Voltage Presence indicator.

QR code compatible for scanning through any device.

Free real time alarming in case of losing power.

Quick activation and subscription for the LoRa connection without paying any additional fees.



EcoStruxure Power Commission application simplifies sensor integration and commissioning (upto 15 Nos. under 30 mins).

Periodic report and updates.

Wireless Sensor for Early Detection of Overheating Cables



SMT10020

HeatTag is a smart sensor for early detection of overheating wire connections or overheating cables. HeatTag helps prevent electrical switchboards from being damaged, by analyzing gas and particles in the air and sending alerts before any smoke or insulator browning.

Standards

The HeatTag smart sensor complies with the following standards:

- IEC 61010-1:2017 UL/CSA/EU CENELEC deviations
- IEC/EN 61326-1b FCC Part 15B and 15C
- ETSI/EN 300328
- ETSI/EN 301489-1
- IEEE 802.15.4

Note:

Do not use HeatTag as a safety device. HeatTag does not replace the fire protection devices of the building.

Presentation

HeatTag smart sensor:

- Sends three levels of alert depending on the severity of the situation it detects.
- Helps prevent potential fire damages by analyzing gas and micro-particles emitted by cable sheaths when overheating.
- Measures temperature and humidity.
- Communicates with all Schneider Electric EcoStruxure panel servers or gateways.
- Is integrated in EcoStruxure solutions.

The HeatTag sensor must be installed only in non-forced air ventilated switchboards. It must be mounted on a DIN rail.

During the first 30 minutes after commissioning, HeatTag can generate an alert for test. It then takes another 8 hours for HeatTag to define its nominal environment and to be fully operational. Each time the HeatTag sensor is powered on, these 30-minute and 8-hour sequences are repeated.

Operation

Paired with Schneider Electric panel servers or gateways, HeatTag reports:

- Alerts
- Air quality index
- Temperature and humidity measurement
- Self-diagnosis information

Air Quality

HeatTag provides an air quality index, ranging from 0 to 10, and displays the air quality evolution trend in a table.

When the air quality index is equal or above 10, HeatTag sends an alert. It has detected abnormal cable sheath heating in the switchboard.

Detection Alert

An alert is triggered when HeatTag detects abnormal cable sheath heating in the switchboard, which can be caused by:

- One or more loose connections (too high contact resistance)
- A poorly sized cable compared to the rated current
- Overcurrent and poorly regulated protective equipment

Alerts are triggered with three severity levels:

- Low level: a cable is slowly overheating in the installation, you must plan a maintenance visit of the installation.
- Medium level: a cable is overheating in the installation, you must go quickly to the installation for maintenance.
- High level: a cable overheats very quickly, you must check the installation immediately.

The orange application led flashes when HeatTag sends an alert to the panel servers or gateways.

Temperature

HeatTag provides a temperature value with a 30 second default transmission period. The transmission period can be increased by the system in case of high wireless data traffic.

Humidity

The HeatTag provides a humidity rate with a 30 second default transmission period. The transmission period can be increased by the system in case of high wireless data traffic.

Self-Diagnosis

HeatTag carries out two types of diagnosis:

- A minor alert is sent when the fan rpm is 80% of its nominal rpm, which means fan clogging.
- A major alert is sent when HeatTag is faulty. In this case it cannot report measures at all, nor reports incorrect measures.

Wireless Sensor for Early Detection of Overheating Cables

HeatTag Smart Design

- No settings
- Nominal environment auto-learning to avoid false alerts
- Concentrator auto-discovery
- Alerts generated by a powerful algorithm integrated in HeatTag

Electrical Characteristics

Supply voltage	110-277 V AC, -15 % / +15 %
Frequency	50-60 Hz
Max. consumption	0.1 A
Operating temperature	-15 °C / +70 °C (5 °F to 158 °F)
Storage temperature	-20 °C / +85 °C (-4 °F to 185 °F)
Relative humidity in operation	15-90 %
Altitude of use	0-2000 m (0-6500 ft)
Degree of pollution (IEC 60664-1)	3
Overvoltage category	OVC III

Sensor Characteristics

Temperature measurement	Measurement range	-15 °C / +70 °C (5 °F to 158 °F)
	Measurement accuracy	-1.1 °C / +1.1 °C
	Default transmission period	30 seconds (higher in case of high wireless data traffic)
Humidity measurement	Measurement range	15-90 %
	Measurement accuracy	±9 RH %
	Default transmission period	30 seconds (higher in case of high wireless data traffic)
Air quality		Index (0 to 10), alert generation when index ≥ 10
Test alert after pairing		During the first 30 minutes
Environment auto-learning phase		8 hours after the first 30 minutes

Installation

Communication Architecture

List of compatible communicators:

- EcoStruxure Panel Servers
- PowerTag Link
- PrismaSeT Wireless Panel Server

Wiring

HeatTag must be protected by 2 A breaker. It is delivered with a separate connector.

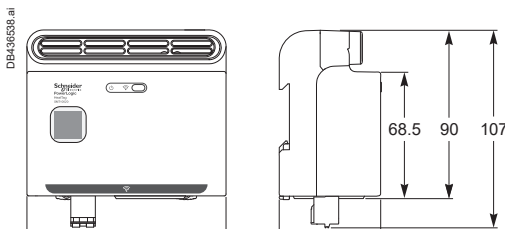
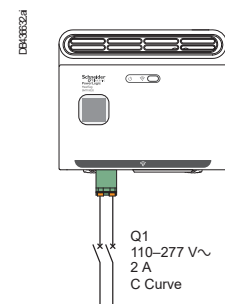

Mechanical Characteristics

Dimensions (w x h x d)	108 x 107 x 55 mm
Weight	270 g
Degree of protection (IEC 60529)	IP30

Wireless Sensor for Early Detection of Overheating Cables

Integration in PrismaSeT P Active

HeatTag must be installed following the Instruction Sheet recommendations (MFR5173801).

DB437105.ai



MFR5173801

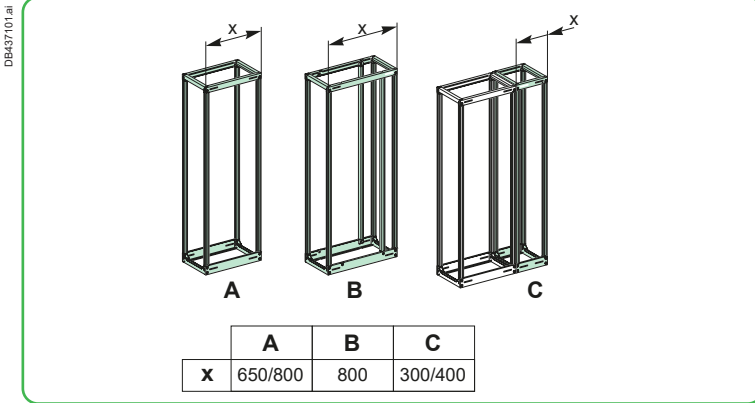

HeatTag must be installed on a DIN rail.

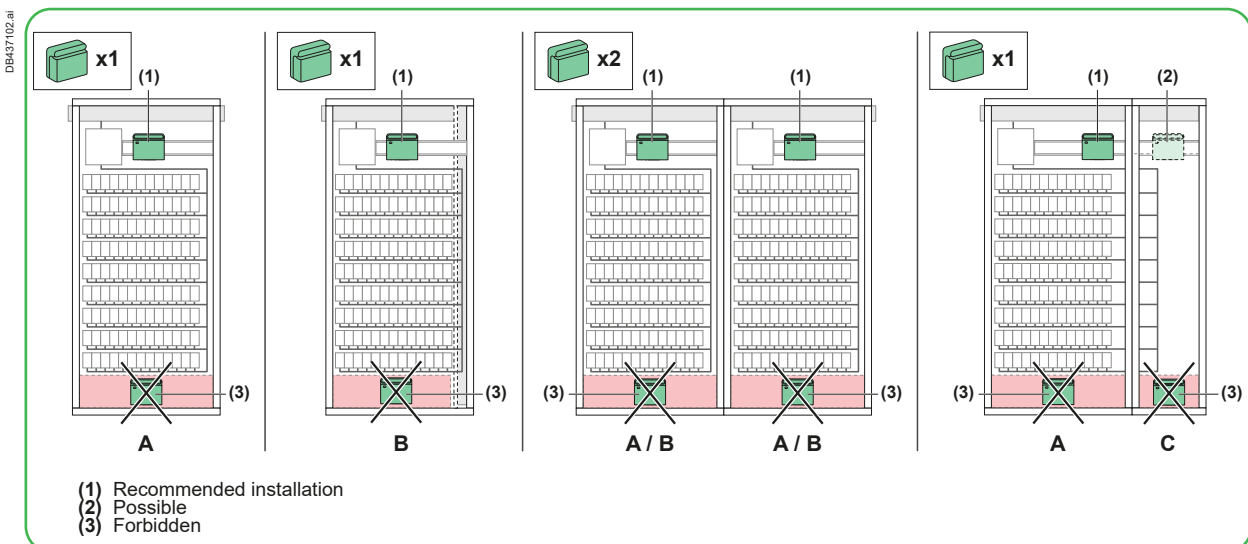
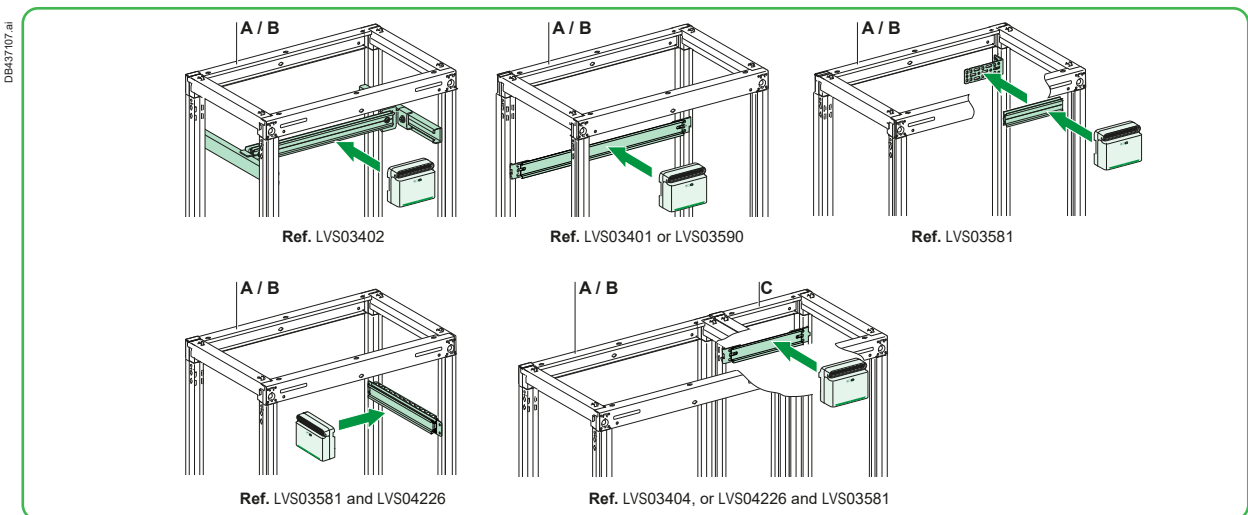

PowerLogic™ HeatTag sensor installed with PrismaSeT P Active Panel server and paired with EcoStructure™ Facility Expert

PrismaSeT P Active
Wireless Panel Server

PowerLogic™ HeatTag sensor

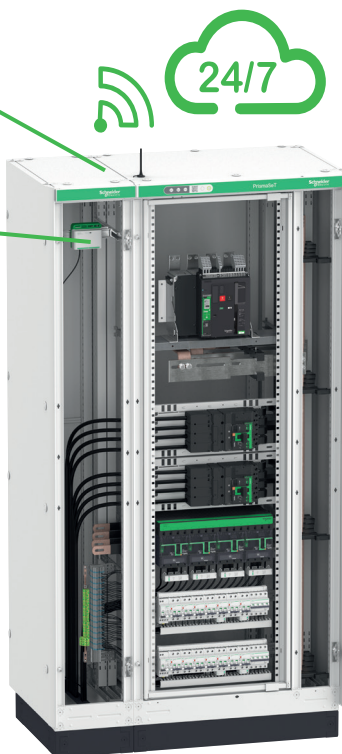

B

Easy to install: directly on a DIN rail in non-forced air-ventilated switchboards.

Easy to commission from your mobile with EcoStructure™ Power Commission.



EcoStructure™ Facility Expert

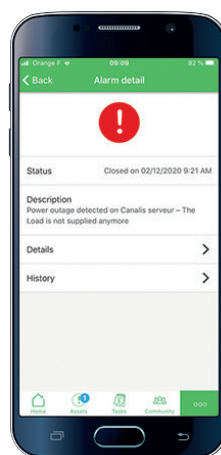

Alert detail

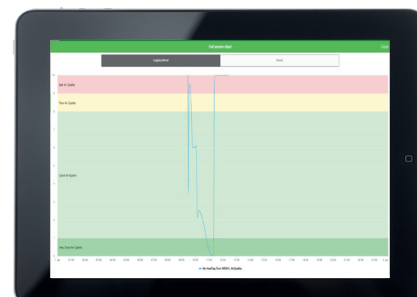

Cause and recommendations



P4000 Switchboard - Presentation



Presentation

In response to the ever increasing performance levels of electrical switchboards in commercial and industrial buildings, Schneider Electric offers a solution for fast and easy installation of a Masterpact MTZ2 in a dedicated PrismaSeT cubicle, thus enhancing the existing offer.

The switchboard is created using standard components, but with busbars sized to handle the thermal effects inherent to such high power levels. Installed alone in a cubicle, the Masterpact MTZ2 is connected upstream via cables or Canalis busbar trunking and supplies horizontal busbars which may consist of Linergy LGYE profile or Linergy BS bar. Current is generally distributed using Linergy busbars installed in adjacent Prisma cubicles.

A dependable electrical installation

The total compatibility of Schneider Electric devices with the PrismaSeT system is a key advantage in ensuring a high level of installation dependability.

System design has been validated by type tests as per standards IEC 61439-1 and IEC 61439-2 and benefits from the combined experience of Schneider Electric customers over many years.

The P4000 switchboard is made up of:

- A dedicated incoming cubicle, 650 mm wide, containing the Masterpact MTZ2. The circuit breaker is always installed in the same position, whether it is fixed or drawout, and whether it is connected using Canalis busbar trunking or cables.
- Combined cubicles for the outgoing circuits.

Linergy LGYE 4000 A profile, supplied by the Masterpact and connected downstream to vertical Linergy LGY, LGYE profile or BS busbars, are used for current distribution. The depth of the cubicles and the selected cover panels are decisive factors (see the electrical characteristics opposite).

P4000 Switchboard - Characteristics

B

Mechanical characteristics

- Steel sheet.
- Surface treatment: electrophoresis + hot-polymerised polyester epoxy powder, white colour RAL 9003.
- Degree of protection:
 - IP30/31, IK08
 - IP55, IK10.
- Dimensions of the dedicated cubicle for the Masterpact MTZ2:
 - W = 650 mm
 - D = 600 mm (front connection) or 1000 mm (rear connection)
 - H = 2000 mm.
- Inside cubicles.

Electrical characteristics

- Rated insulation level of main busbars: 1000 V.
 - Rated operational current: see table below.
 - Rated peak withstand current: I_{pk} up to 220 kA.
 - Rated short-time withstand current: I_{cw} up to 100 kA rms/1 s.
 - Frequency: 50/60 Hz.
 - Compliant with standards IEC 61439-1 & 2.
 - Form 1 (covers for upstream and downstream terminals on all devices).
- In a dedicated incoming cubicle, it is not necessary to cover the busbars.

Rated operational current

The rated operational current depends on:

- the ambient temperature around the switchboard.

The values indicated below are for device connections to the busbars and customer connections in a switchboard where the ambient temperature is 35 °C

- the degree of protection for the cubicle
- the depth of the cubicle
- the type of front cover (door or cover frame).

In all cases, it is necessary to install ventilation accessories.

Rated current	Cubicle depth	Front cover	Connection mode	Ventilation accessories
IP30 switchboard				
3440 A	600 mm	plain door (for cut-outs)	front cables	ventilated roof + grill with filter
3520 A	600 mm	cover frame (no door)	front cables	ventilated roof
	or 1000 mm	plain door (for cut-out) or cover frame (no door)	rear cables or Canalis	ventilated roof + grill with filter
IP31 switchboard				
3440 A	600 mm	plain door (for cut-outs)	front cables	ventilated roof + grill with filter
3520 A	1000 mm	plain door (for cut-outs)	rear cables or Canalis	ventilated roof + grill with filter
IP55 switchboard				
3520 A	600 mm	plain door (for cut-outs)	front cables	IP55 front or side fan ⁽¹⁾ + IP55 grill with filter
	or 1000 mm	plain door (for cut-outs)	rear cables	IP55 front or side fan ⁽¹⁾ + IP55 grill with filter

⁽¹⁾ Installed on a side panel that must be cut out.

P4000 Switchboard - Cubicle Configuration

Cubicle, D = 600,
front connection

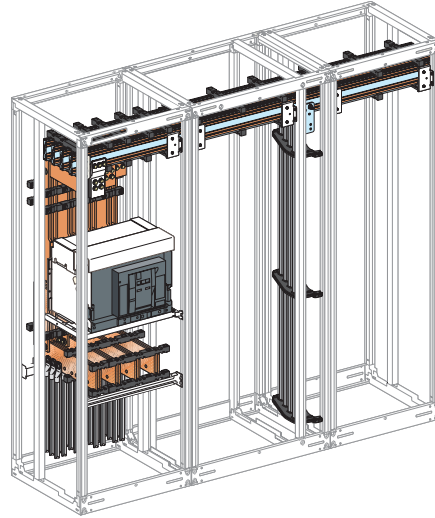

P4000 switchboard with front connection.

Cubicle, D = 1000,
rear connection

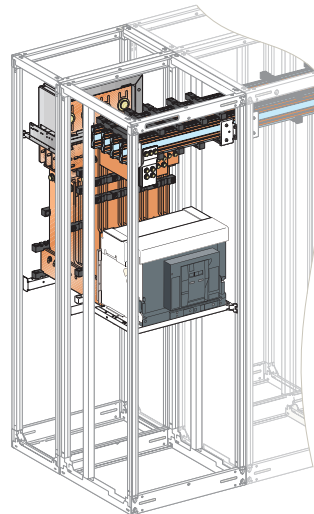

Connection using Canalis busbar trunking.

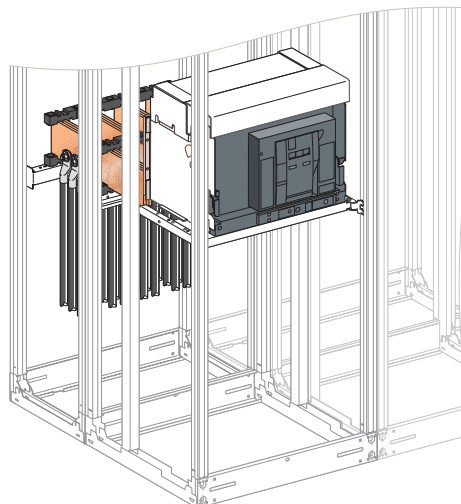

Connection using cables via top or bottom.

Architecture

Contents

Functional units

Connection - Device installation and distribution	C-2
Horizontal busbars - Linergy LGYE profile or Linergy BS busbars	C-3

Enclosures

IP30 enclosures	C-5
IP31 enclosures	C-6
IP55 enclosures	C-7

Connection - Device installation and distribution

Functionnal units

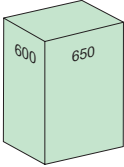
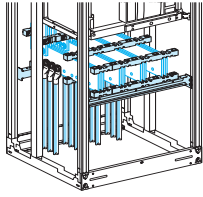
Mounting	Front connection using cables (from bottom)	
		
Devices	Fixed MTZ2	Drawout MTZ2
Downstream connection adapter 4000 A	3P: LVS04644 x 3 4P: LVS04644 x 4	3P: LVS04644 x 3 4P: LVS04644 x 4
Busbar supports	3P/4P: LVS04694 x 2	3P/4P: LVS04694 x 2 + LVS04678 x 2
Connection bars	<i>must be made</i>	<i>must be made</i>

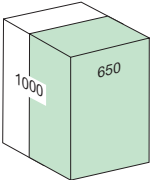
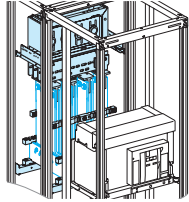
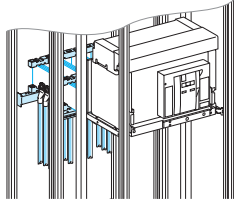
Mounting	Rear connection using Canalis busbar trunking (from bottom)	Rear connection using cables (top or bottom)		
				
Devices	Fixed MTZ2	Drawout MTZ2	Fixed MTZ2	Drawout MTZ2
Downstream connection adapter 4000 A	3P: LVS04644 x 3 4P: LVS04644 x 4	3P: LVS04644 x 3 4P: LVS04644 x 4	3P: LVS04644 x 3 4P: LVS04644 x 4	3P: LVS04644 x 3 4P: LVS04644 x 4
Busbar supports	3P/4P: LVS04694 x 2	3P/4P: LVS04694 x 2 + LVS04678	3P/4P: LVS04694 x 2	3P/4P: LVS04694 x 2
Connection bars	<i>must be made</i>	<i>must be made</i>	<i>must be made</i>	<i>must be made</i>
Connection + Canalis support + Canalis/device interface	3P: LVS04737 4P: LVS04738	3P: LVS04737 4P: LVS04738	-	-

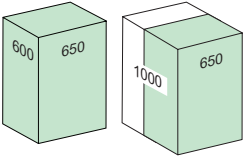
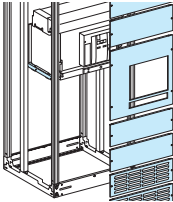
Mounting	Device installation	
		
Devices	Fixed MTZ2 3P/4P	Drawout MTZ2 3P/4P
No. of vertical modules	36	36
Mounting plates	LVS03500	LVS03500
Front plate with cut-outs	LVS03710	LVS03710
Upstream front plate	LVS03804 x 2 + LVS03895 x 2 [1]	LVS03804 x 2 + LVS03895 x 2 [1]
Downstream front plate	LVS03895 x 2 + LVS03804 + LVS03803	LVS03895 x 2 + LVS03803 x 2

[1] Front plate LVS03895: ventilated front plate.

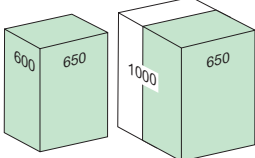
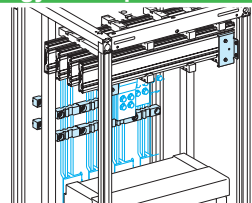
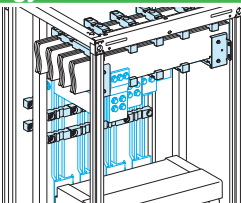
Mounting	Linergy LGYE profile distribution	Linergy BS distribution
		
Devices	Fixed/drawout MTZ2	Fixed/drawout MTZ2
Downstream connection adapter 4000 A	3P: LVS04644 x 3 4P: LVS04644 x 4	3P: LVS04644 x 3 4P: LVS04644 x 4
Busbar supports for connection between device / busbars	3P: (LVS04664 + LVS04646) x 2 + LVS04678 x 2 4P: (LVS04662 + LVS04646) x 3 + LVS04678 x 2	3P: (LVS04664 + LVS04671) x 2 + LVS04678 x 2 4P: (LVS04662 + LVS04671) x 3 + LVS04678 x 2
Connection between device / busbars	<i>must be made</i>	<i>must be made</i>

Horizontal busbars - Linergy LGYE profile or Linergy BS bar

Functional units

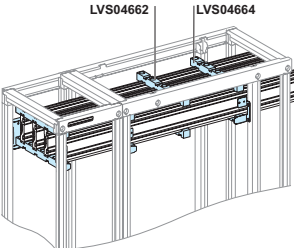
Mounting		Horizontal busbars for combined cubicles				
	No. of supports	≤ 25	1	1	2	2
	lcw (kA rms/1 s)	≤ 30	1	1	2	2
		≤ 40	1	1	2	2
		≤ 50	1	2	2	2
		≤ 60	2	2	2	2
		≤ 65	2	2	3	3
		≤ 75	2	2	3	3
		≤ 85	2	2	3	3
		≤ 100	-	-	-	4
	Framework width		W = 300	W = 400	W = 650/800	W = 650/800
No. of bars Linergy LGYE		Profile 4000 A	Profile 4000 A	-	Profile 4000 A	
No. of bars Linergy BS		2 bars 120 x 10	2 bars 120 x 10	2 bars 120 x 10	-	

Note: the permissible current values for the busbars are given for an ambient temperature of 35 °C around the switchboard.

Mounting	Profile/bar selection	
	Linergy LGYE	Linergy BS
Width	2000	2000
Bars	Profile 4000 A	120 x 10
Catalogue numbers	LVS04568	LVS04552
Number of bars per phase	1	2

Mounting	Selection of busbar supports	
	Linergy LGYE	Linergy BS
Fixed support	LVS04664 + LVS04646	LVS04664 + LVS04671
Free support	LVS04662 + LVS04646	LVS04662 + LVS04671
Characteristics	Two fixed supports for frameworks W = 650 and one fixed support for frameworks W = 300/400 are mandatory. If more supports are required, use free supports.	

Busbars connection

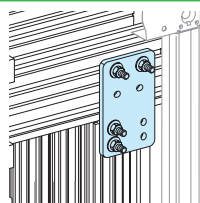
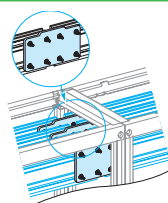
Mounting	Connection between horizontal and vertical busbars 4000 A		Joints	
				
	Linergy LGYE	Linergy BS	Linergy LGYE	Linergy BS
Catalogue numbers	LVS04607	LVS04638	3P: LVS04623 4P: LVS04623 + LVS04624	LVS04643
Characteristics	Used to connect the horizontal busbars to vertical busbars (Linergy LGYE profile or Linergy BS bar).			

Note: the vertical bars:
 - Linergy LGY profile and BS bar must be shortened 50 mm.
 - Linergy LGYE profile must be shortened 375 mm.
 (order one catalogue number per phase)

Horizontal busbars - Linergy LGYE profile or Linergy BS bar

Functionnal units

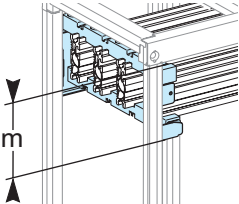
Mounting	Busbar dimension
	
No. of modules	4
Characteristics	Horizontal Linergy LGYE profile or Linergy BS bar installed at the bottom or top of cubicle.

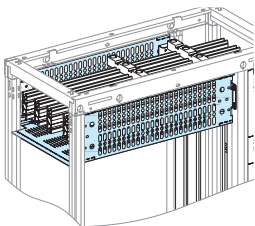
Mounting	Cover for horizontal busbars
	
Framework width	W = 300 W = 400 W = 650 W = 650 + 150 W = 800
No. of modules	4 4 4 4 4
Catalogue numbers	LVS04963 LVS04964 LVS04966 LVS04966 LVS04968
Number of bars per phase	Set of two barriers (front and rear), plus a slotted rear panel for efficient natural convection in the switchboard. The set can be used to partition horizontal busbars installed at the top or bottom of the cubicle. The space required for the busbars is not increased.

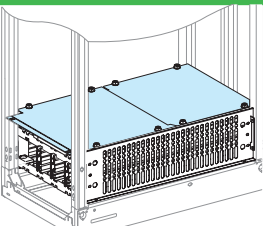
Mounting	Plain barrier
	
	W = 300, W = 400 W = 650, W = 800
Catalogue numbers	LVS04915 LVS04919
Characteristics	To protect horizontal busbars installed at the bottom of the cubicle, the slotted horizontal panel can be replaced by a plain barrier.

Horizontal busbars

Size / phase	Permissible current (A)											
	Ambient temperature around the switchboard											
	25 °C		30 °C		35 °C		40 °C		45 °C		50 °C	
	IP ≤ 31	IP > 31	IP ≤ 31	IP > 31	IP ≤ 31	IP > 31	IP ≤ 31	IP > 31	IP ≤ 31	IP > 31	IP ≤ 31	IP > 31
Linergy LGYE, profile 4000 A	3800	3510	3710	3430	3620	3350	3450	3180	3280	3020	3120	■
Linergy BS, two bars 120 x 10	4160	3760	3960	3550	3760	3340	3560	3100	3340	2880	3120	■

■ Connection impossible due to temperature limits for the devices.

Characteristic: derating of horizontal busbars is indicated for natural ventilation.

IP30 Enclosures

Enclosures

Front connection using cables

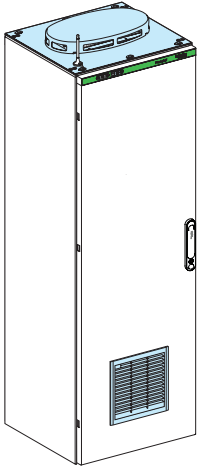

Rated operational current I_n 3440 A for an ambient temperature of 35 °C around the switchboard

Framework LVS08606

W = 650 mm.

D = 600 mm.

Hinged front plate

Support frame LVS08566.

Cover panels

IP30 cover panels with:

- plain door LVS08516, must be cut out for grill with filter LVS08988 (supplied with a standard filter)
- ventilated roof LVS08676
- side panel LVS08760
- rear panel LVS08736.

Front connection using cables

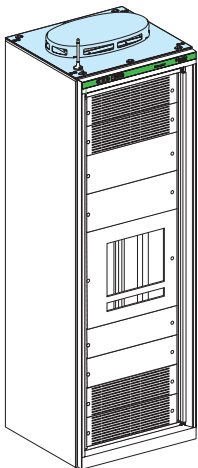

Rated operational current I_n 3520 A for an ambient temperature of 35 °C around the switchboard

Framework LVS08606

W = 650 mm.

D = 600 mm.

Hinged front plate

Support frame LVS08566.

Cover panels

IP30 cover panels with:

- cover frame LVS08556
- ventilated roof LVS08676
- side panel LVS08760
- rear panel LVS08736.

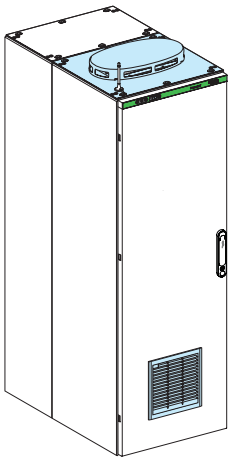
Rear connection using cables
or Canalis busbar trunking**Framework LVS08606 + LVS08406**

W = 650 mm.

D = 1000 mm.

Hinged front plate

Support frame LVS08566.

Cover panels

IP30 cover panels with:

- cover frame LVS08556 or plain door LVS08516, must be cut out for grill with filter LVS08988 (supplied with a standard filter)
- ventilated roof D = 600, LVS08676
- plain roof LVS08436
- side panel LVS08760 + LVS08750
- rear panel LVS08736.

IP31 Enclosures

Enclosures

Front connection using cables

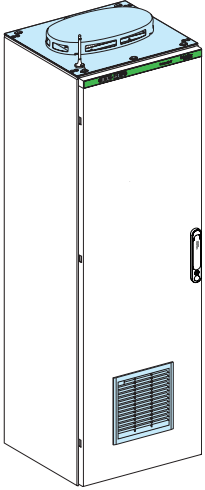
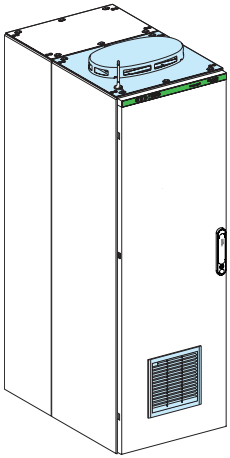
Rear connection using cables
or Canalis busbar trunking

Rated operational current I_n 3440 A for an ambient temperature of 35 °C around the switchboard

Framework LVS08606

W = 650 mm.
D = 600 mm.

Hinged front plate

Support frame LVS08566.

Cover panels

IP30 cover panels with:

- plain door LVS08516, must be cut out for grill with filter LVS08988 (supplied with a standard filter)
- ventilated roof LVS08676
- IP30 sealing kit LVS08711
- side panel LVS08760
- rear panel LVS08736.

Rated operational current I_n 3520 A for an ambient temperature of 35 °C around the switchboard

Framework LVS08606 + LVS08406

W = 650 mm.
D = 1000 mm.

Hinged front plate

Support frame LVS08566.

Cover panels

IP30 cover panels with:

- plain door LVS08516, must be cut out for grill with filter LVS08988 (supplied with a standard filter)
- ventilated roof D = 600, LVS08676
- IP30 sealing kit LVS08711
- plain roof LVS08436
- side panel LVS08760 + LVS08750
- rear panel LVS08736.

IP55 Enclosures

Enclosures

Front connection using cables

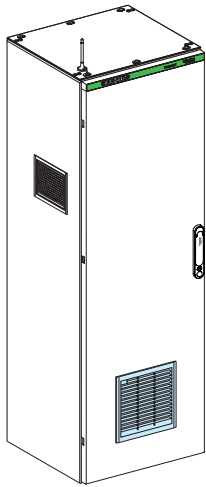

Rear connection using cables

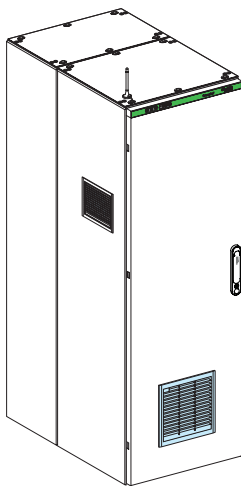

Cut-outs in cover panels

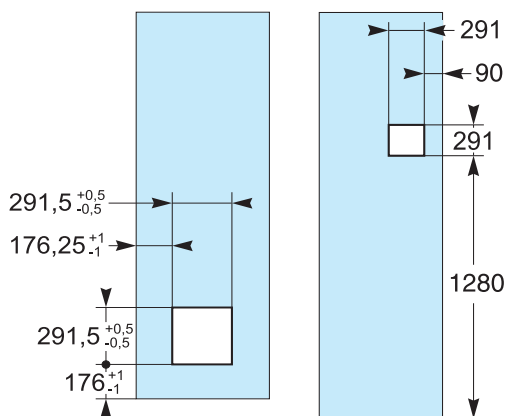

Rated operational current I_n 3520 A for an ambient temperature of 35 °C around the switchboard

Framework LVS08606

W = 650 mm.
D = 600 mm.

Hinged front plate

Support frame LVS08566.

Cover panels

IP55 cover panels with:

- plain door LVS08526, must be cut out
- side panel LVS08765, must be cut out
- plain roof LVS08656
- rear panel LVS08746.

Ventilation accessories (1)

IP55 grill with filter.
IP55 front or side fan.

Framework LVS08606 + LVS08406

W = 650 mm.
D = 1000 mm.

Hinged front plate

Support frame LVS08566.

Cover panels

IP55 cover panels with:

- plain door LVS08526, must be cut out
- side panel LVS08765, must be cut out
- plain roof LVS08656 + LVS08456
- rear panel LVS08746
- side panel LVS08755.

Ventilation accessories (1)

IP55 grill with filter.
IP55 front or side fan.

(1) Ventilation accessories (see catalogue "Universal Enclosure" in ClimaSys CV part).

Designation		Catalogue number
IP55 grill with filter (supplied with standard filter: maximum throughput 350 m³/h)		LVS08988
IP55 front or side fan (throughput 850 m³/h)	230 V	NSYCVF850M230PF
	400 V	NSYCVF850M400PF
5 fine filters		LVS08990

Characteristics

Electrical characteristics

Determining the busbars

D-2

D

Determining the busbars

Electrical characteristics

Dedicated incoming cubicle

Customer connection and connection between device and busbars with three 120 x 10 bars

Use the tables below to determine the maximum permissible currents in three 120 x 10 bars used for customer connections and the connections between the Masterpact MTZ2 and the busbars, as a function of the ambient temperature around the switchboard and its IP level.

Connections must be made using the supplied plans.

IP30 switchboard Enclosures	Permissible current (A) Ambient temperature around the switchboard					
	25 °C	30 °C	35 °C	40 °C	45 °C	50 °C
D = 600 mm front cover frame	3680	3600	3520	3440	3340	3120
D = 600 mm plain door for cut-outs	3600	3520	3440	3340	3120	2900
D = 1000 mm cover frame or plain door for cut-outs	3680	3600	3520	3440	3340	3120

IP31 switchboard Enclosures	Permissible current (A) Ambient temperature around the switchboard					
	25 °C	30 °C	35 °C	40 °C	45 °C	50 °C
D = 600 mm plain door for cut-outs	3600	3520	3440	3340	3120	2900
D = 1000 mm plain door for cut-outs	3680	3600	3520	3440	3340	3120

IP55 switchboard Enclosures	Permissible current (A) Ambient temperature around the switchboard					
	25 °C	30 °C	35 °C	40 °C	45 °C	50 °C
D = 600 mm plain door for cut-outs	3680	3600	3520	3440	3340	■
D = 1000 mm plain door for cut-outs						

■ - Impossible connection due to limited temperature for the device



Life Is On

Schneider
Electric

Schneider Electric Industries SAS

35, rue Joseph Monier
CS 30323
92506 Rueil Malmaison Cedex
France

RCS Nanterre 954 503 439
Capital social 896 313 776 €
www.se.com

12-2021
430E25000

© 2021 - Schneider Electric. All Rights Reserved.
All trademarks are owned by Schneider Electric Industries SAS or its affiliated companies.
Document reference: DESW024EN

This document has been
printed on recycled paper

