

Liquid Freezer III 280

Multikompatibler All-in-One CPU-Wasserkühler



Allgemeine Spezifikationen

Kompatibilität	Intel® LGA1851, LGA1700 AMD® AM5, AM4
PI NNPI	319 259
Wärmeleitpaste	MX-6 (0,8g)
Garantie	6 Jahre
Betriebsumgebungstemperatur	0-40°C
Gewicht	1705 g
All-In-One-Anschluss	4-Pin-PWM-Buchse

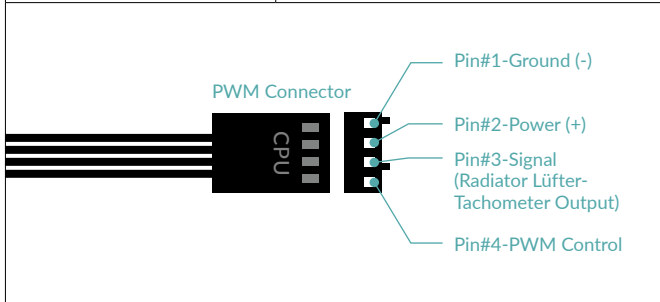

Geteilter Anschluss	3x 4-Pin-PWM-Buchse
---------------------	---------------------

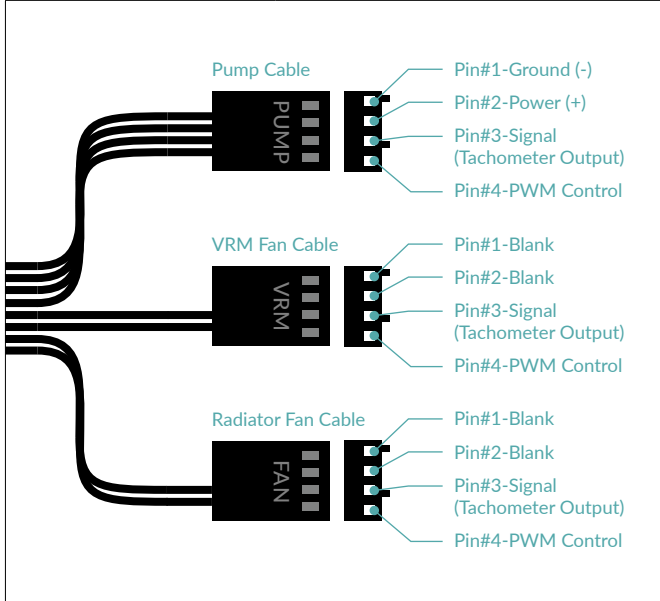

Pumpe	800-2800 rpm (PWM-gesteuert)
Strom Spannung	0,35 A 12 V DC
Cold Plate	Kupfer, Micro-Skived-Fins
Schlauchlänge	450 mm
Schlauchdurchmesser	Äußerer: 12,4 mm Innerer: 6,0 mm
Radiator	
Material	Aluminium
Abmessungen	317 (L) x 138 (B) x 38 (H) mm
VRM-Modul	
VRM-Lüfter	400-2500 rpm (PWM-gesteuert)
Strom Spannung	0,05 A 12 V DC

Radiatorlüfter-Spezifikationen

Allgemein	2x P14 PWM
Geschwindigkeit	200-1700 rpm
Luftstrom	72,80 cfm 123,76 m³/h
Statischer Druck	2,40 mmH₂O
Lager	Hydrodynamisches Gleitlager
Strom Spannung	0,12 A 12 V DC
Kabellänge	40 mm
Anschluss	4-Pin-PWM-Buchse

Versandinformationen - LF III 280 (Black)

Box Abmessungen	335 (L) x 170 (B) x 155 (H) mm
Brutto Gewicht	2233 g
SKU	ACFRE00135A
EAN	4895213704472
UPC	840033402248

Liquid Freezer III 280

Multikompatibler All-in-One CPU-Wasserkühler

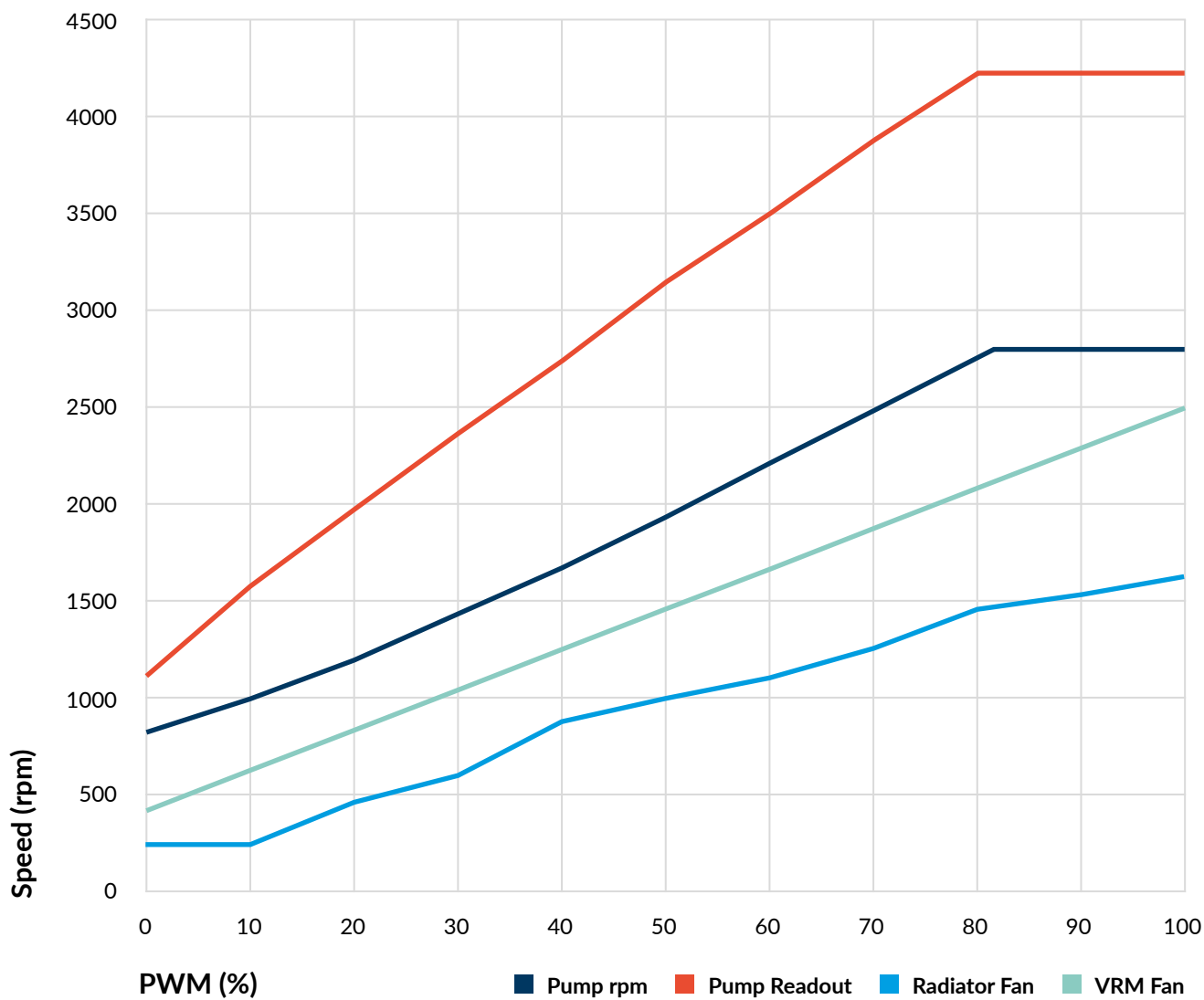

Liquid Freezer III 280

Multikompatibler All-in-One CPU-Wasserkühler

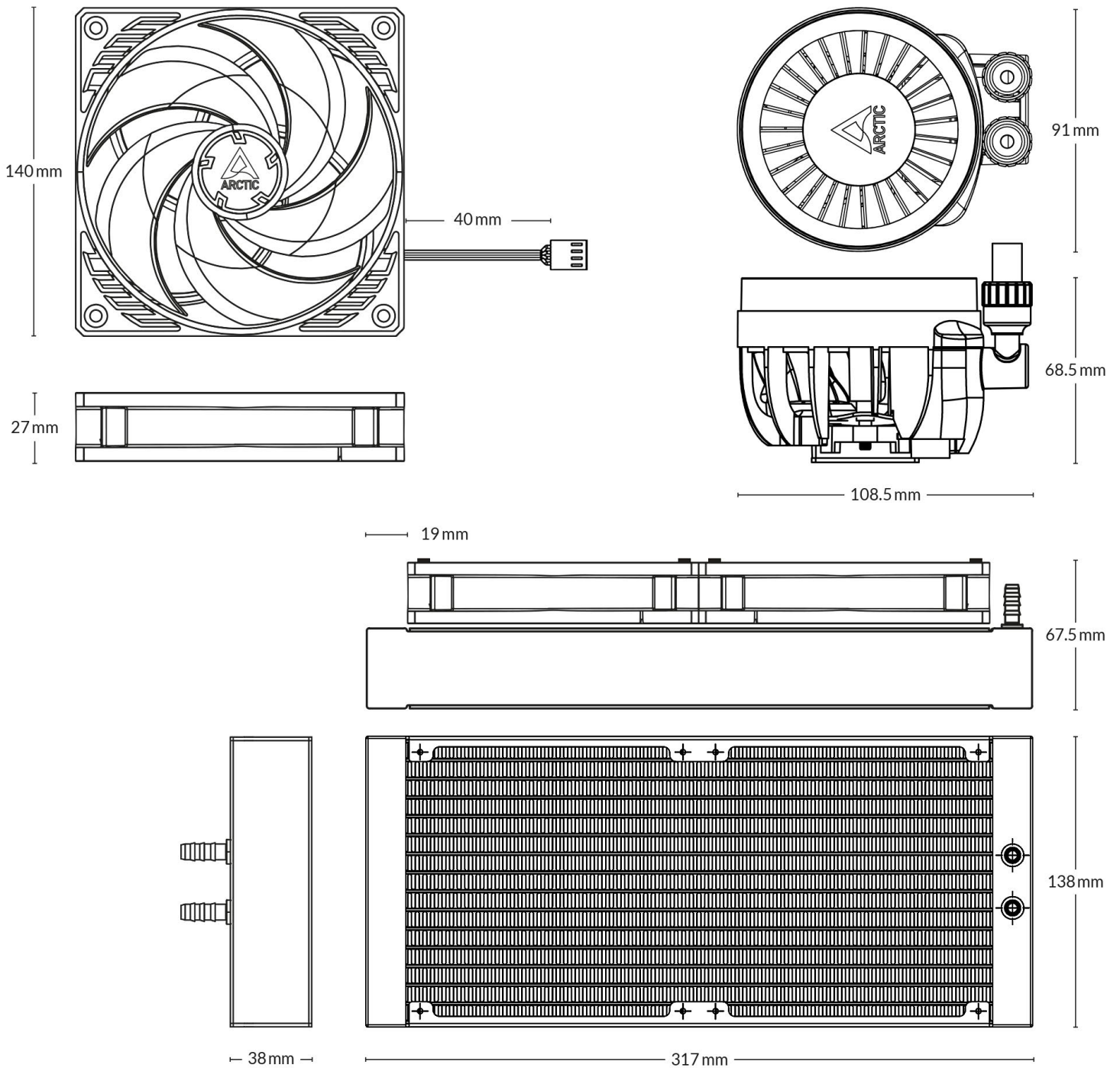

Alle Materialien sind mit den RoHS-Anforderungen kompatibel.

WEITERE INFORMATIONEN



ANLEITUNGEN

