

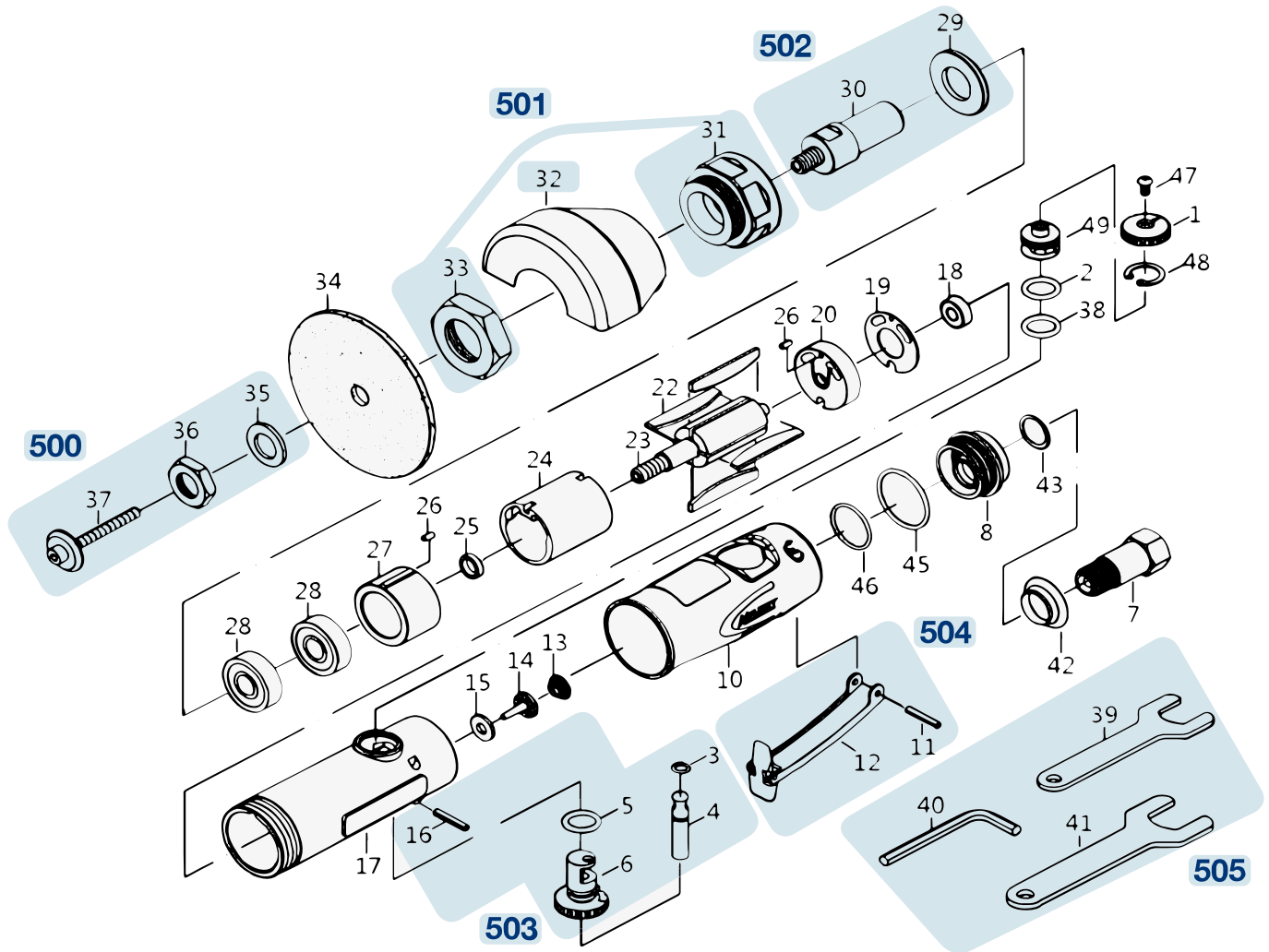

Ersatzteile 9033-10

Spare parts · Pièces de rechange



Pos	HAZET No.	Bezeichnung	Designation	Désignation	
32	9033-10-01	Abdeckscheibe	Cover disc	Disque de couverture	1
500	9033-10-02/3	Befestigungs Satz · Inhalt: 35 · 36 · 37	Fastening set · Contents: 35 · 36 · 37	Kit de fixation · Contenu : 35 · 36 · 37	3
501	9033-10-03/2	Befestigungsmuttern Satz · Inhalt: 31 · 33	Fixing nuts set · Contents: 31 · 33	Jeu d'écrous de fixation · Contenu : 31 · 33	2
502	9033-10-04/2	Scheibenarretierung · Inhalt: 29 · 30	Washer locking · Contents: 29 · 30	Blocage de rondelle · Contenu : 29 · 30	2
503	9033-10-05/5	Ventil-Schaft · Inhalt: 3 · 4 · 5 · 6 · 16	Valve stem · Contents: 3 · 4 · 5 · 6 · 16	Tige de soupape · Contenu : 3 · 4 · 5 · 6 · 16	5
504	9033-10-06/2	Betätigungshebel · Inhalt: 11 · 12	Operating lever · Contents: 11 · 12	Gâchette · Contenu : 11 · 12	2
505	9033-10-07/3	Spannschlüssel Satz · Inhalt: 39 · 40 · 41	Tensioner adjuster set · Contents: 39 · 40 · 41	Jeu de clés de tension · Contenu : 39 · 40 · 41	3



DE

HAZET Service online:
www.hazet.de/de/home/service/



EN

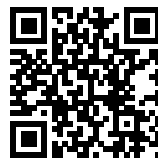



DE

HAZET Ersatzteil-Shop
HAZET Spare-parts-shop:
www.hazet.de/ersatzteil-shop



EN

Zur Bestellung und für Rückfragen wenden Sie Sich bitte an unsere Service-Abteilung
For Orders and questions please refer to our service-centre

 +49 (0) 21 91 / 7 92 355 ·  +49 (0) 21 91 / 7 92 523 ·  service-center@hazet.de

HAZET-WERK – Hermann Zerver GmbH & Co. KG ·  10 04 61 · 42804 REMSCHEID

 Gùldenwerther Bahnhofstrasse 25 – 29 · 42857 REMSCHEID · GERMANY