

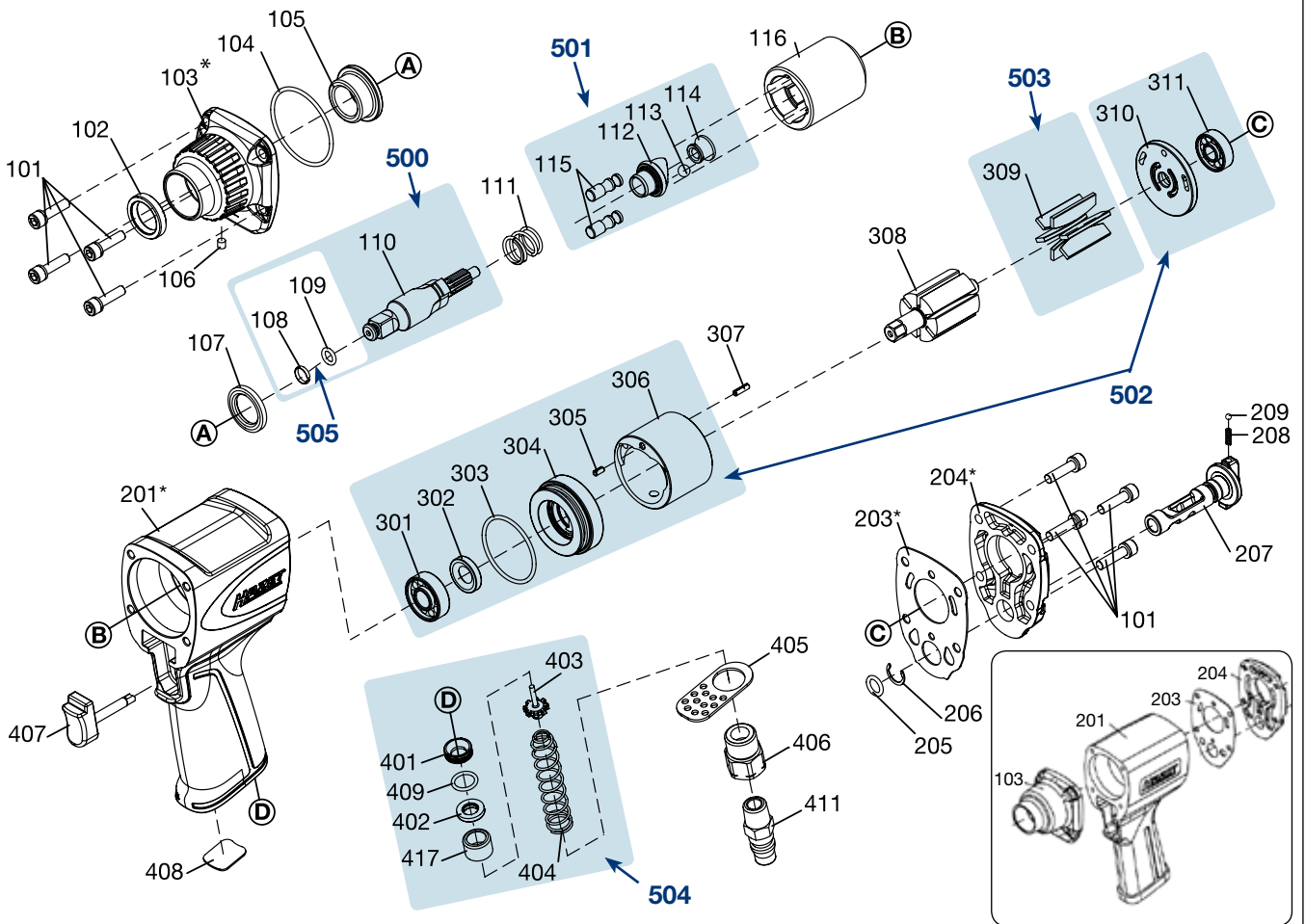











Erersatzteile 9011 MG



	HAZET No.	Bezeichnung	Name	Name	
101	9011MG-03/8	Gehäuseschraube	Bolt assy	Vis de boîtier	8
102	9011MG-05/5	Dichtungsring	Oil seal	Joint d'étanchéité	1
103	9011MG-06	Schlagwerkgehäuse	Hammer case	Boîtier de mécanisme de frappe	1
103*	9011MG-06N	Schlagwerkgehäuse	Hammer case	Boîtier de mécanisme de frappe	1
104	9011MG-07/5	O-Ring	O - Ring	Joint torique	1
105	9011MG-08/3	Schlagwerkbuchse	Hammer case bushing	Douille de mécanisme de frappe	1
106	9011MG-09/10	Schmiernippel	Lubricating nipple	Graisseur conique	1
107	9011MG-010/2	Scheibe	Washer	Rondelle	1
111	9011MG-011/5	Feder	Spring	Ressort	1
116	9011MG-012	Schlagwerkkorb	Hammer frame	Cage de mécanisme de frappe	1
201	9011MG-013	Gehäuse	Housing	Boîtier	1
201*	9011MG-013N	Gehäuse	Housing	Boîtier	1
203	9011MG-04/10	Gehäuse-Dichtung	Gasket	Point de boîtier	1
203*	9011MG-04/10N	Gehäuse-Dichtung	Gasket	Point de boîtier	1
204	9011MG-014	Hintere Gehäuseabdeckung	Rear cover	Capot de boîtier arrière	1

	HAZET No.	Bezeichnung	Name	Désignation	
204*	9011MG-014N	Hintere Gehäuseabdeckung	<i>Rear cover</i>	<i>Capot de boîtier arrière</i>	1
205	9011MG-015/15	O-Ring	<i>O - Ring</i>	<i>Joint torique</i>	1
206	9011MG-016/10	Sicherungsring	<i>CTW - Ring</i>	<i>Circlip</i>	1
207	9011MG-017	Steuerungsventil	<i>Reverse valve</i>	<i>Valve de commande</i>	1
208	9011MG-018/15	Feder	<i>Spring</i>	<i>Ressort</i>	1
209	9011MG-019/15	Kugel	<i>Steel ball</i>	<i>Bille</i>	1
307	9011MG-020/15	Stift	<i>Spring pin</i>	<i>Goupille</i>	1
308	9011MG-021	Rotor	<i>Rotor</i>	<i>Rotor</i>	1
405	9011MG-022/5	Luftleitblech	<i>Exhaust deflector</i>	<i>Déflexeur d'air</i>	1
406	9011MG-023	Lufteinlaß	<i>Air inlet</i>	<i>Admission d'air</i>	1
407	9011MG-024	Abzugshebel	<i>Trigger unit</i>	<i>Levier de tirage</i>	1
408	9011MG-025/10	Auslaßsieb	<i>Muffler</i>	<i>Tamis d'échappement</i>	1
500	9011MG-01/3	Vierkant	<i>Anvil</i>	<i>Carré</i>	1
		Inhalt: 108, 109, 110	<i>Contents: 108, 109, 110</i>	<i>Contenu: 108, 109, 110</i>	
501	9011MG-01/5	Stiftschlagwerk	<i>Hammer-Set</i>	<i>Système de frappe à marteau</i>	1
		Inhalt: 112, 113, 114, 115 (2x)	<i>Contents: 112, 113, 114, 115 (2x)</i>	<i>Contenu: 112, 113, 114, 115 (2x)</i>	
502	9011MG-01/8	Zylindereinheit	<i>Cylinder-Set</i>	<i>Unité de vérin</i>	1
		Inhalt: 301, 302, 303, 304, 305, 306, 310, 311	<i>Contents: 301, 302, 303, 304, 305, 306, 310, 311</i>	<i>Contenu: 301, 302, 303, 304, 305, 306, 310, 311</i>	
503	9011MG-01/6	Lamellen	<i>Blades</i>	<i>Lamelles</i>	1
		Inhalt: 309 (6x)	<i>Contents: 309 (6x)</i>	<i>Contenu: 309 (6x)</i>	
504	9011MG-02/6	Ventileinheit	<i>Valve-Set</i>	<i>Unité de soupape</i>	1
		Inhalt: 401, 402, 403, 404, 409, 417	<i>Contents: 401, 402, 403, 404, 409, 417</i>	<i>Contenu: 401, 402, 403, 404, 409, 417</i>	
505	9011MG-01/2	Ringsatz	<i>Ring-Set</i>	<i>Jeu d'anneaux</i>	1
		Inhalt: 108, 109	<i>Contents: 108, 109</i>	<i>Contenu: 108, 109</i>	
		* Ersatzteil für neue Ausführung / neues Design ab 2013	<i>* Spare part for new version / new design from 2013</i>	<i>* Pièce détachées pour nouvelle génération / nouveau design depuis 2013</i>	
Positionen, die keine HAZET-No. haben, können über die HAZET-Service-Abteilung bestellt werden					

Zur Bestellung und für Rückfragen wenden Sie sich bitte an unsere Service-Abteilung.
 +49 (0) 21 91/7 92 355 •  +49 (0) 21 91/7 92 523 •  service-center@hazet.de

HAZET - WERK Hermann Zerver GmbH & Co. KG •  10 04 61 • D-42804 Remscheid • Germany
 Güldenwerther Bahnhofstraße 25 - 29 • D-42857 Remscheid •  www.hazet.de •  info@hazet.de
 +49 (0) 21 91 / 7 92-0 •  +49 (0) 21 91 / 7 92-375 (National) •  +49 (0) 21 91 / 7 92-400 (International)