

RGB FLOW

ATX PC CASE



Sharkoon



Let the colors flow: The RGB FLOW from Sharkoon presents itself as an elegant yet unobtrusive ATX midi tower with its tempered glass side panel and black chassis with clear lines. The minimalistic design is intersected by a stream of colors which flows through two integrated LED strips from the front panel to the side of the case, providing the built-in hardware with an atmospheric highlight. The RGB FLOW is not just an eye-catcher. With its mesh element on the front panel, locations for six fans or a radiator and numerous installation possibilities for data storage, it is also an ideal home for your hardware.

GO WITH THE FLOW

The RGB FLOW is equipped with addressable LED strips which visually connect the front and side panel. Both strips are daisy chained and can be easily operated using the four-port RGB controller which is integrated in the case. Fourteen illumination modes can be selected using the case's reset switch. Alternatively, the LED strips and three more RGB components can be controlled via a mainboard with appropriate software and an RGB header with a 5V-D-coded-G or 5V-D-G pin configuration.



WINDOW WITH RGB HIGHLIGHT

The RGB FLOW has a side panel made of tempered glass, behind which the installed hardware is displayed. The side panel is without obvious fastening and is attached only to the back of the case with easily removable thumb screws. In addition, the hardware is put into perspective, illuminated in a choice of colors thanks to the LED strip at the bottom of the glass panel.

4-PORT ADDRESSABLE RGB CONTROLLER

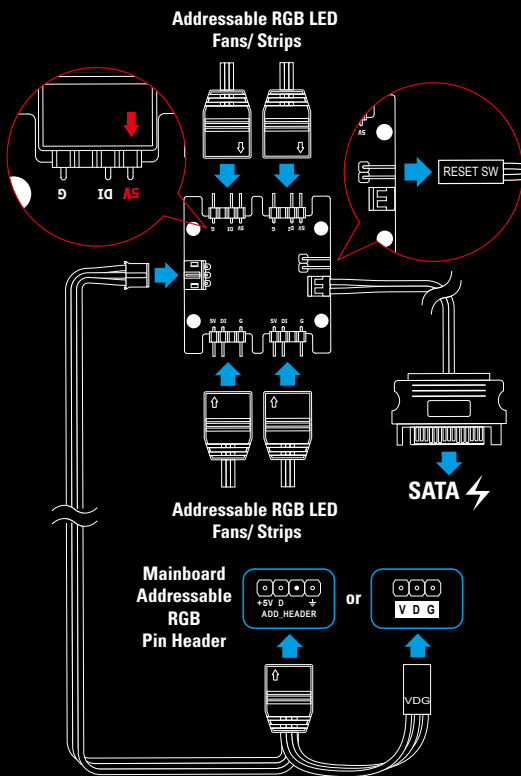

The RGB FLOW comes with a pre-installed RGB controller. This allows up to four addressable LED components to be controlled and synchronized via the mainboard software. The controller is connected to the power supply via a SATA connector and to either a mainboard 4-pin or 3-pin header for addressable LEDs with the configuration: 5V-D-coded-G or V-D-G.



MANUAL COLOR CONTROL

The RGB FLOW also has a manual color control function for mainboards which do not have headers for addressable LED components. With this, the RGB controller is not connected to the mainboard, but rather connected to the power supply and the reset switch of the PC case. The switch's reset function is then replaced with a new function which allows up to fourteen lighting modes to be cycled through and selected, or, if desired, the lighting can be turned off.

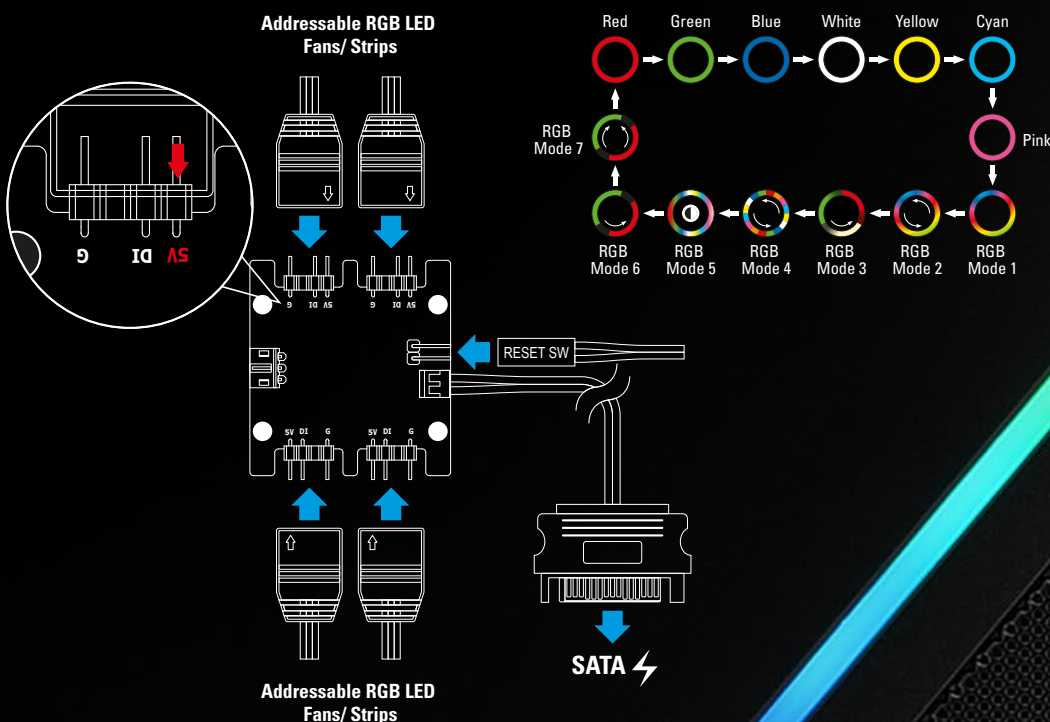

EASY TO INTEGRATE

The RGB FLOW case, along with all other Sharkoon products marked with the Addressable RGB logo, are certified for Asus Aura Sync, MSI Mystic Light Sync, Gigabyte Fusion and ASRock Polychrome SYNC. Optionally available SHARK Blades RGB fans and strips can also be easily incorporated into existing systems.

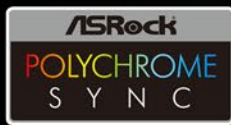

**ADDRESSABLE
RGB**

Sharkoon products marked with the "ADDRESSABLE RGB" logo are compatible with mainboards which have headers for addressable RGB LED fans and strips. The headers should have the pin configuration 5V-D-coded-G or 5V-D-G. Examples of these RGB connections from the most important mainboard manufacturers are shown below. The RGB pin configuration is independent of manufacturer. However, the naming and marking of these connections may vary between manufacturers. For further information concerning compatibility, refer to the manual of your mainboard, or visit the manufacturer's website.



MSI

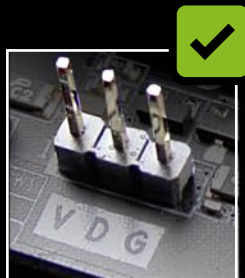

GIGABYTE



ASUS

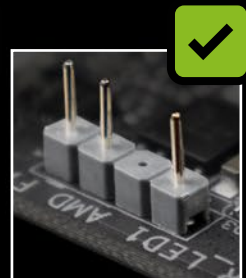

ASROCK

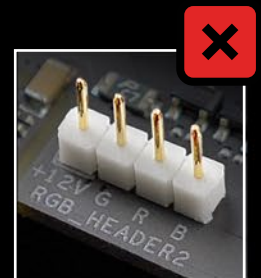

ASUS

COMPACT DESIGN WITH POWER SUPPLY TUNNEL

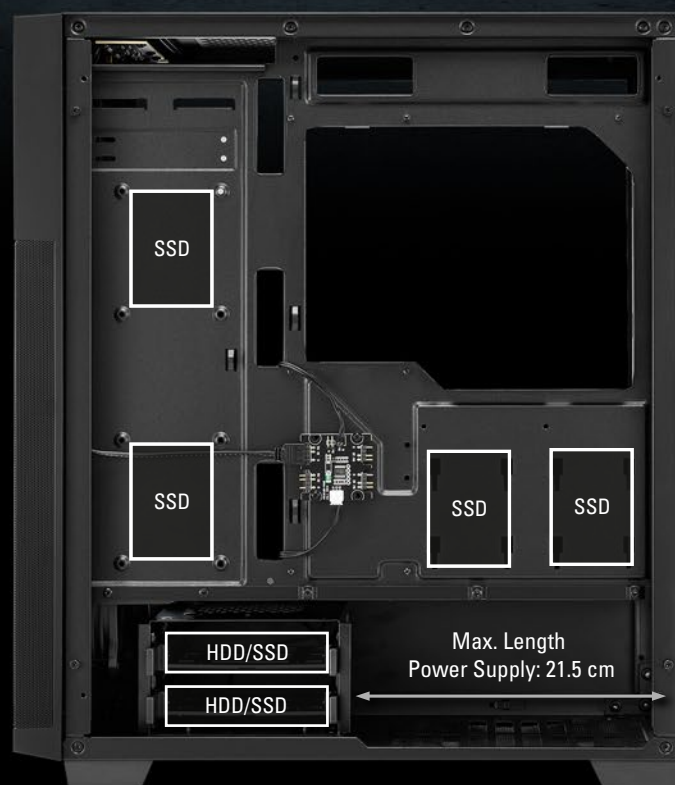
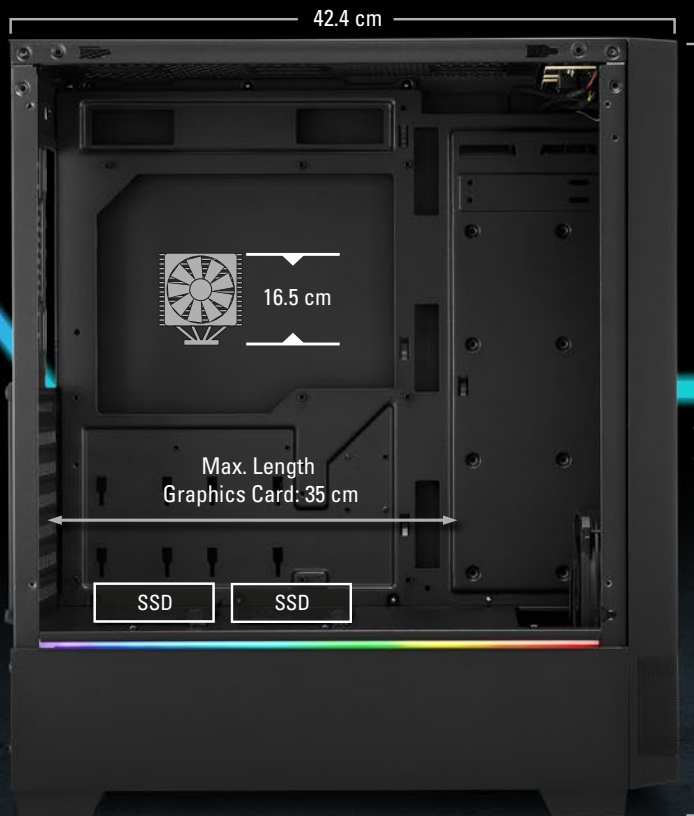

48.1 cm

The RGB FLOW has a compact design that can cut a fine figure anywhere, without having to make compromises in terms of compatibility.



Removable Dust Filters



4-Port Addressable RGB Controller



Removable HDD/SSD Cage



Extra-Long Thumbscrew Slots for the Flexible Positioning of the HDD/SSD Cage



Stable Case Feet

OPTIMAL AIRFLOW

Optional Installation Possibilities:

1x 120 mm Fan

2x 120 mm Fans

Detachable Front Panel



1 x 120 mm Fan
(Pre-Installed)

Beneath the LED strip on the front panel, the ATX midi tower is equipped with a fine mesh grille, ensuring an optimal intake of air which is supplied by the pre-installed 120 mm fan. If desired, five more fans can be installed within the case. Two additional 120 mm fans will have room behind the front panel, while one more fan can be installed on the back panel and another two under the top panel. Despite the compact design, the RGB FLOW also has room for radiators (incl. fans): 6.4 cm is provided for this behind the front panel and 5.5 cm under the top panel.

ADAPTABLE HDD/SSD CAGE

Removable HDD/SSD Cage

Decoupled Mounting for
Noise Reduction from Vibration



If additional space is needed behind the front panel, the HDD/SSD cage can be quickly and easily repositioned using the extra-long thumbscrew slots on the bottom of the case. If the cage is not required, it can also be completely removed, and one 3.5" HDD can be still installed on the bottom panel.

SPECIFICATIONS

General:

■ Form Factor:	ATX
■ Expansion Slots:	7
■ Interior Painting:	✓
■ Tool-Free Devices Installation:	✓
■ Cable Management System:	✓
■ Side Panel:	Tempered Glass
■ Weight:	6.0 kg
■ Dimensions (L x W x H):	42.4 x 20.6 x 48.1 cm

RGB Compatibility:

■ Type:	Addressable
■ Port:	4-Port
■ Manual Control:	14 Modes
■ Mainboard Compatibility:	MSI Mystic Light Sync, ASUS Aura Sync, Gigabyte RGB Fusion Ready, ASRock Polychrome SYNC
■ RGB Pinout:	5V-D-G & 5V-D-coded-G

I/O:

■ USB 3.0 (Top):	2
■ USB 2.0 (Top):	1
■ Audio (Top):	✓

Maximum Drive Bays:

■ 3.5":	2
■ 2.5":	6

Fan Configuration:

■ Front Panel:	1x 120 mm Fan (Pre-Installed) 2x 120 mm Fan (Optional)
■ Rear Panel:	1x 120 mm Fan (Optional)
■ Top Panel:	2x 120 mm or 2x 140 mm Fan (Optional)

Compatibility:

■ Mainboard:	Mini-ITX, Micro-ATX, ATX
■ Max. Length Graphics Cards:	35 cm
■ Max. Height CPU Cooler:	16.5 cm
■ Max. Length Power Supply:	21.5 cm
■ Max. Height Radiator incl. Fan (Front):	6.4 cm
■ Max. Height Radiator incl. Fan (Top):	5.5 cm
■ Radiators (Optional):	Up to 360 mm (Front Panel) Up to 280 mm (Top Panel)

Package Contents:

■ RGB FLOW
■ Accessory Set
■ Manual



RGB FLOW
ATX PC CASE