

SYSKON | P500, P800, P1500, P3000 and P4500 **Computer Controlled Laboratory Power Supplies**

3-349-373-03
13/10.16



Contents	Page	Contents	Page		
1	Initial Inspection – Warnings	3	9	Status and Events Management	56
2	Initial Start-Up – Dimensional Drawings	4	10	Table of Operating and Query Commands	58
2.1	Dimensional Drawing SYSKON P500 / P800 / P1500	4	10.1	Adjustable Functions and Parameters	58
2.2	Dimensional Drawing SYSKON P3000 / P4500	5	10.2	Queryable Functions and Parameters	60
2.3	Preparing for Operation	6	10.3	Sequence Status Diagram	62
2.3.1	Installing the Optional GPIB Interface Module	6	10.4	Memory Structure	63
2.3.2	Setup as Benchtop Device	6			
2.3.3	Installation to a 19" Device Cabinet	6	11	System Messages	64
2.3.4	Connection to the Mains	6	12	Operating Software	66
2.3.5	Connecting Power Consumers	6	13	Index	69
2.3.6	Connection to Computer Interfaces	6	14	Order Information	70
2.3.7	Driver update (USB device driver)	7	15	Repair and Replacement Parts Service Calibration Center* and Rental Instrument Service	70
2.3.8	Connecting the Analog Interface	7	16	Product Support	70
2.4	Switching the Device On	7	17	Manufacturer's Guarantee	70
2.4.1	Table of Firmware Versions	8			
2.4.2	Response after Power ON with Varying Line Voltage Ranges (230 V ↔ 115 V)	8			
3	Technical Description	9			
4	Technical Data	12			
4.1	General Data	12			
4.1.1	Electromagnetic Compatibility	13			
4.1.2	Ambient Conditions	13			
4.2	Mechanical Data	14			
4.2.1	Terminals (rear panel)	14			
4.3	Electrical Data	15			
4.3.1	Reference Conditions	17			
5	Controls, Display Elements and Terminals	18			
5.1	Front Panel SYSKON P500 / P800 / P1500	18			
5.2	Rear Panel P500 / P800 / P1500	20			
5.3	Front Panel SYSKON P3000, P4500	22			
5.4	Rear Panel SYSKON P3000, P4500	24			
6	Menu Structure and Parameters	26			
7	Analog Interface	28			
7.1	Connector pin assignments	28			
7.2	Auto-sensing mode	30			
7.3	Status Signal Outputs	30			
7.4	Regulating Output Voltage	31			
7.5	Controlling Output Current	31			
7.6	Voltage Monitoring Output	32			
7.7	Current Monitoring Output	32			
7.8	Trigger Inputs	33			
7.9	Parallel Connection	34			
7.9.1	Direct Parallel Connection	34			
7.9.2	Master-Slave Parallel Connection	35			
7.10	Series Connection	36			
7.10.1	Direct Series Connection	36			
7.10.2	Master-Slave Series Connection	37			
7.11	Varying the Internal Output Resistance Value	38			
8	Descriptions of Operating Commands	39			



Note

These operating instructions describe devices as from firmware version 005, see chapter 2.4.1.

1 Initial Inspection – Warnings

When unpacking the instrument, make sure that the KONSTANTER and all included accessories are fully intact and have not been damaged during transport.

Unpacking

- Other than the usual care exercised in handling electronic equipment, no additional precautions are required when unpacking the instrument.
- The KONSTANTER is delivered in recyclable packaging, which provides for adequate protection during transport as substantiated by testing. If the instrument is repacked at a later point in time, the same packaging or its equivalent must be used.

Visual inspection

- Compare the order number or type designation included on the packaging and/or the serial plate with the particulars shown in the shipping documents.
- Make sure that all accessory components have been included (see chapter 14 “Options and Accessories”).
- Inspect the packaging, as well as mechanical instrument and accessory components for possible transport damage.

Complaints

If damage is discovered, immediately file a claim with the freight forwarder (save the packaging!). If other defects are detected or in the event that service is required, inform your local representative, or contact us directly at the address included on the last page of this handbook.

Use for Intended Purpose

Use of the KONSTANTER for its intended purpose is only fulfilled if the instrument is used in accordance with the stipulations set forth in the respective operating instructions, and is operated within the specified power limits. The Konstanter may only be used by persons with appropriate technical knowledge, or who have received appropriate instruction.

In order to prevent danger during use, shock-proof connector cables must be used when connecting power consumers. The KONSTANTER's output values (U, I) must be adjusted such that no danger of overloading or destruction exists for the connected power consumer.

Only then can the safety of the user, the instrument and the device under test or the power consumer be assured.

Warnings and Safety Precautions

The KONSTANTER has been manufactured and tested in accordance with the electrical safety regulations listed under Technical Data as a safety class I device, and has been shipped from the factory in flawless technical safety condition. In order to maintain this condition and to assure safe operation, users must observe all notes and warnings included in these operating instructions.



Attention!

A note concerning operation, practical advice or other information which must be adhered to in order to prevent damage to the **KONSTANTER**, and to assure correct operation.



Warning!

An operating procedure, practical advice or other information which must be adhered to in order to assure safe operation of the **KONSTANTER**, and to prevent personal injury.
The most important warnings are summarized below.



Warning!

Protective Grounding, PE Connection

The KONSTANTER may only be placed into operation after the protective conductor has been connected. Interruption or disconnection of the protective conductor may result in danger for the user. The device is connected to the mains by means of a 3 conductor cable with mains plug.



Warning!

Opening the Housing Covers

Remove the mains plug from the outlet before opening the housing. When the housing covers are opened, voltage conducting parts may be exposed. Any contact with these exposed conductive parts is life endangering. For this reason, the instrument may only be opened by trained personnel who are familiar with the dangers involved.



Warning!

Repair by Trained Personnel

Maintenance and repair work, as well as internal balancing, may only be performed by trained personnel who are familiar with the respective functions, and the dangers involved. After the instrument has been disconnected from the mains, wait approximately 5 minutes in order to allow the capacitors to discharge themselves to safe voltage levels.



Warning!

Replacing Fuses

Only specified fuse types with the specified nominal current rating may be used to replace blown fuses (see Technical Data and specifications on the serial plate). Manipulation of the fuses and/or the fuse holder is prohibited.



Attention!

Impaired Safety

If it can be assumed that safe operation is no longer possible, the KONSTANTER must be removed from service and secured against inadvertent use. Safe operation is no longer possible:

- If the KONSTANTER demonstrates visible damage or transport damage
- If the KONSTANTER no longer functions
- After lengthy periods of storage under conditions which deviate from the specified storage conditions

Significance of Symbols



Indicates EC conformity

This instrument fulfills the requirements of applicable European and national EC directives. This is confirmed by means of the CE mark. A corresponding declaration of conformity can be requested from GMC-I Messtechnik GmbH.



Observe ESDS guidelines



Warning concerning a point of danger (attention: observe documentation!)



The device may not be disposed of with the trash. Further information regarding the WEEE mark can be accessed at www.gossenmetrawatt.com by entering the search term WEEE.

2 Initial Start-Up – Dimensional Drawings

2.1 Dimensional Drawing SYSKON P500 / P800 / P1500

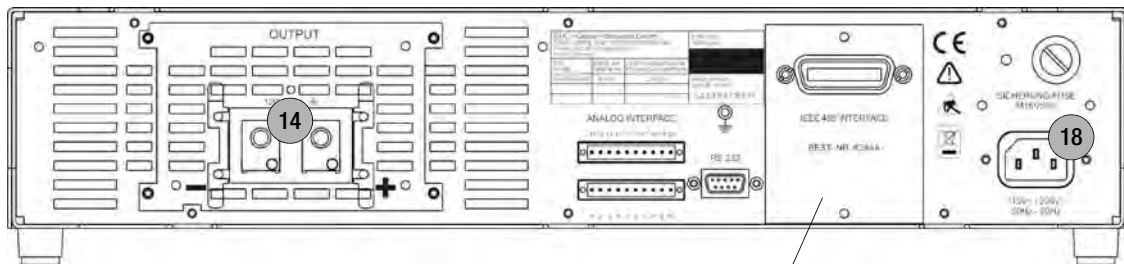
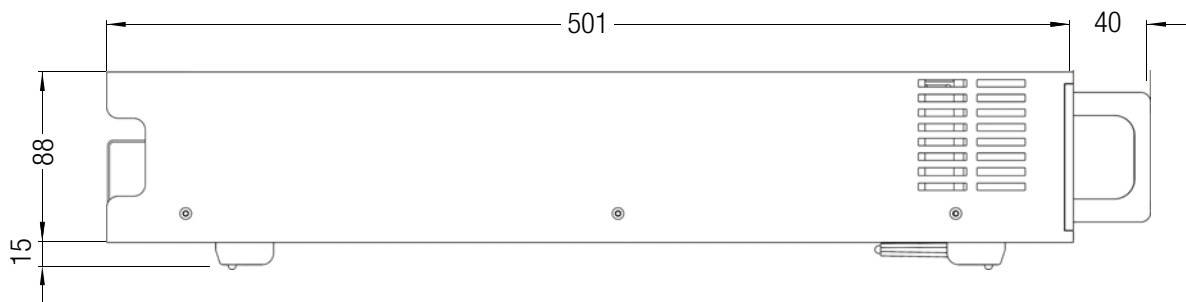
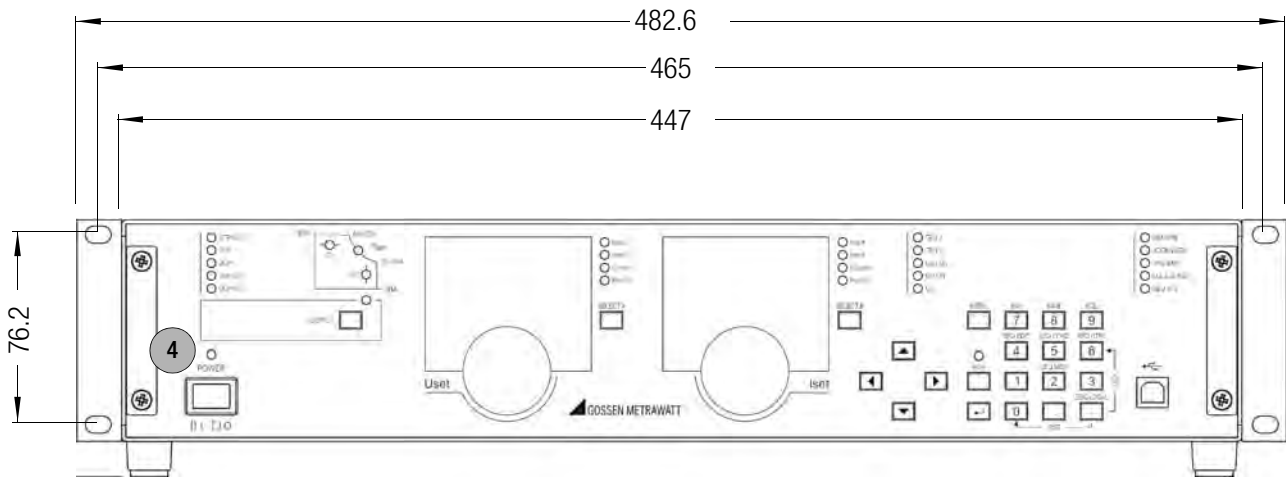

Installation position for optional IEEE-488 interface (material no. K384A).

All dimensions in mm

2.2 Dimensional Drawing SYSKON P3000 / P4500

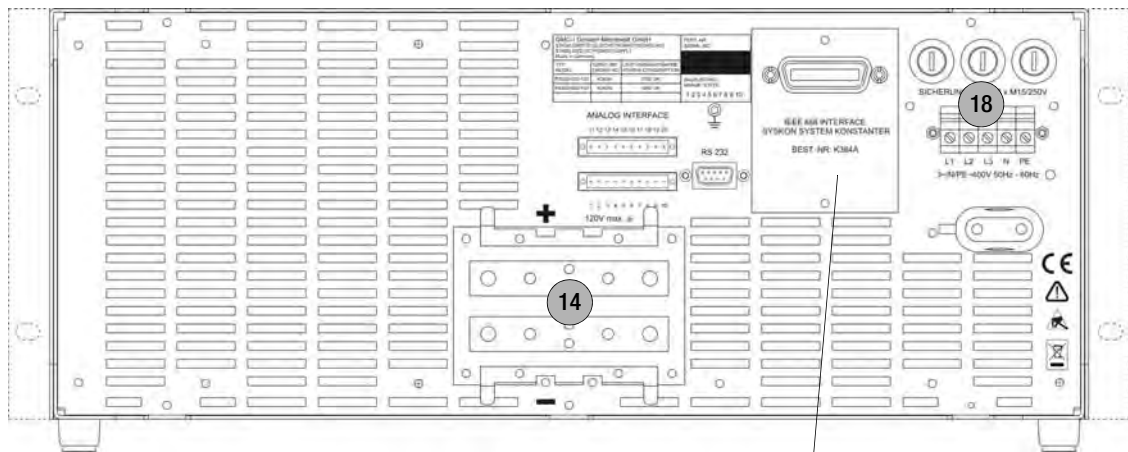
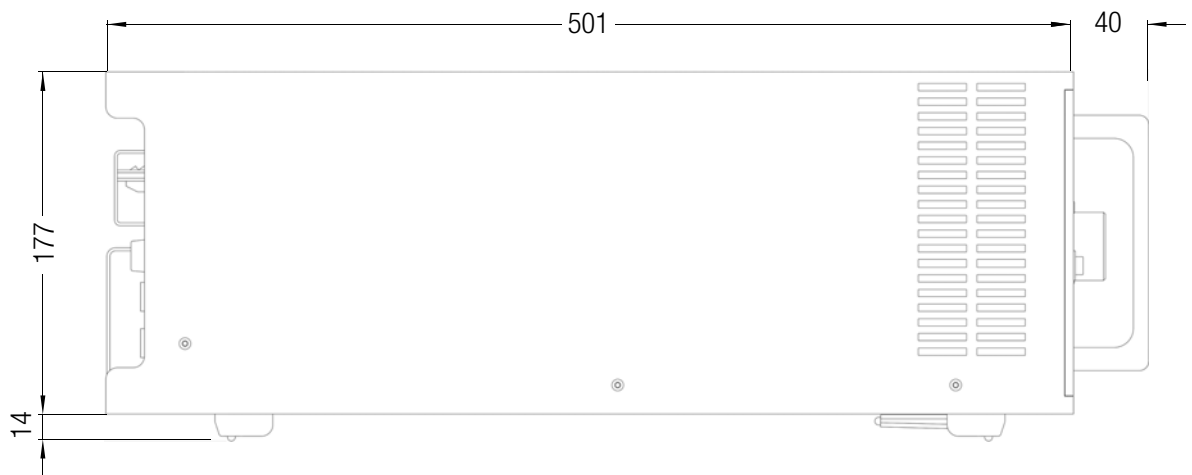
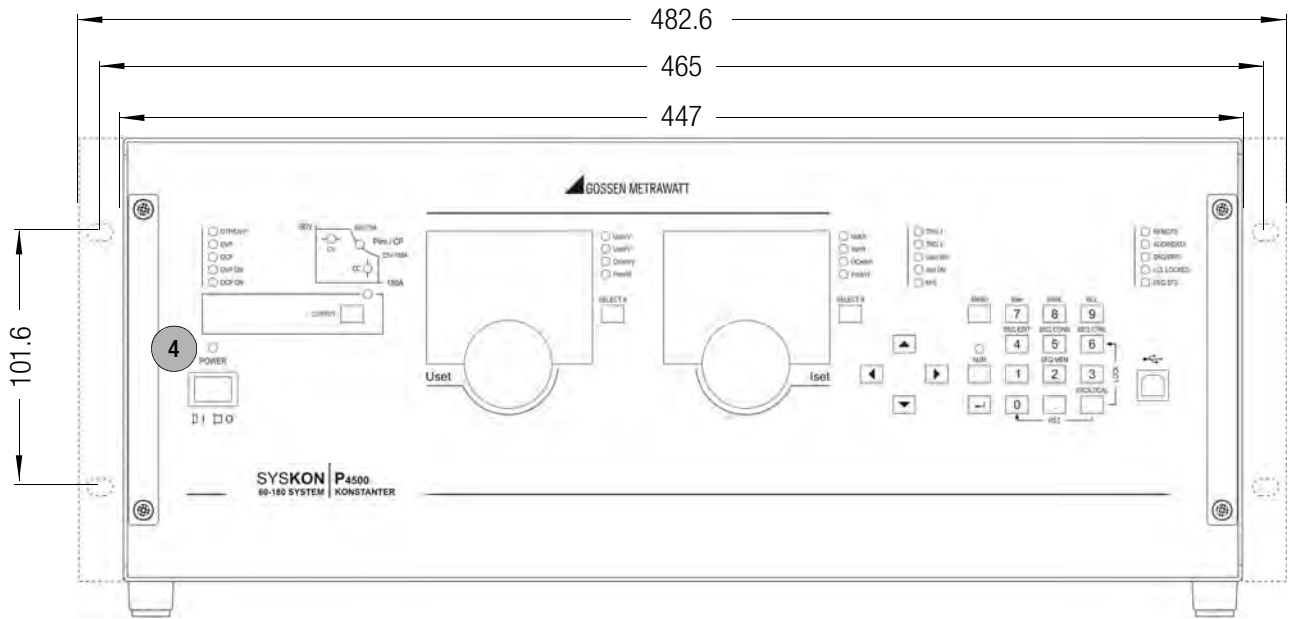

Installation position for optional interface IEEE-488 (material no. K384A).

All dimensions in millimeter

2.3 Preparing for Operation

Note: Numbers in brackets make reference to the items listed in the dimensional drawing.

2.3.1 Installing the Optional GPIB Interface Module



Warning!

The device must be switched off when installing the interface module. **Remove the mains plug from the outlet.** The interface module may be damaged by electrostatic discharge. ESDS handling guidelines must be adhered to. Do not touch electrical contacts or components.

1. Unscrew the cover plate at the right-hand side of the rear housing panel.
2. Carefully remove the ribbon cable from the cable uptake and plug it in, being certain to observe coding as shown on the interface module.
3. Carefully insert the connected module into the opening and secure it with the previously removed cover plate screw.

2.3.2 Setup as Benchtop Device

The instrument is shipped as a benchtop device and the feet are already installed. The mounting tabs for installation to a 19" rack are shipped loose. The instrument can be set up as a benchtop device and placed into operation. Unimpaired ventilation of the instrument must be assured during setup.

2.3.3 Installation to a 19" Device Cabinet

The SYSKON KONSTANTER housing allows for use as a benchtop instrument, as well as for installation to a 19" rack.

The benchtop instrument can be quickly converted to a rack mount device:

1. Unscrew the handles at the front.
2. Pull out the filler strips at the sides and replace them with the included rack-mount fastening tabs.
3. Replace the front handles (if you prefer to leave the handles off, turn M4 screws with a maximum length of 8 mm into the threaded holes).
4. Unscrew the feet from the bottom of the housing.
5. Save all loose parts for possible future use.



Attention!

The instrument must be attached at both sides to guide rails inside the device cabinet. The guide rails, as well as the front panel mounting screws, are cabinet-specific and must be procured from your rack supplier.

2.3.4 Connection to the Mains



Warning!

Protective Grounding, PE Connection

The KONSTANTER may only be placed into operation after the protective conductor has been connected. Interruption or disconnection of the protective conductor may result in danger for the user. The device is connected to the mains by means of a 3 conductor cable with mains plug.



Attention!

Before switching the SYSKON KONSTANTER on, it must be assured that available mains power complies with the supply power values specified at the mains connection on the back of the device.

SYSKON P500/P800/P1500: The device can be operated with either 115 or 230 V mains power. Full output power (1500 W) can be taken advantage of when operated with 230 V mains power. Due to resulting input current, only 750 W of output power can be supplied when operated with 115 V mains power.

SYSKON P3000/P4500: In order to exploit the full nominal power, the device must be operated with a 400 Volt 3-phase current system.

Integrated monitoring circuits detect mains power and limit output power in the event of overloading.

The instrument is connected to a mains outlet with earthing contact via the mains inlet connector [18] at the rear panel with the help of the included power cable (only included with the SYSKON P500/P800/P1500).

2.3.5 Connecting Power Consumers

The output leads are connected to the output terminal blocks [14] at the rear panel by means of ring-type cable lugs with the included screws. (**SYSKON P500/P800/P1500:** M6 x 10, **SYSKON P3000/P4500:** M8 x 12 and M6 x 10). In addition to this, 4 mm holes are also provided which are intended for the connection of any utilized measurement cables.

Connection:

- Remove the safety cap.
- Connect the output leads to the terminal blocks with the provided screws and washers.
- An adequate wire cross-section and correct polarity must be assured. It is advisable to twist the output leads and to identify polarity at both ends.
- Avoid exerting excessive force at the terminals.
- Align the leads to the openings in the safety cap.
- Snap the safety cap back into place.

In order to be able to take advantage of highly constant output voltage at the consumer even if long leads are used, sensing leads can be used to compensate for voltage drops within the output leads (see chapter 7).

The terminals for the sensing leads are located on the analog interface.

2.3.6 Connection to Computer Interfaces

Three interfaces are available on the instrument for computer-controlled operation.

The device is furnished with a USB port and an RS 232 interface as standard equipment.

A GPIB interface can be ordered as an optional module and installed as described. Installation at a later point in time is also possible.

The instrument cannot be remote controlled via more than one interface at a time. It is thus advisable to connect the desired interface only.

In order to avoid communications problems with the interfaces, only one interface should be connected to the computer. Problems may otherwise occur.

In order to assure that existing bus activity is not interfered with, all affected devices should be switched off while establishing the bus connection.

All of the interfaces have a common reference point (GND) which is connected to PE, and are isolated from the output in accordance with the specified electrical safety regulations.

a) **USB Port**

The type B USB plug is at the at the bottom right-hand side of the front panel. Appropriate USB drivers must be installed, which are on the included CD or can be downloaded from the Internet, see chapter 2.3.7.

b) **RS 232C Interface**

The socket connector for the RS 232 interface is on the instrument's rear panel. A 9-pin subminiature socket connector is used to this end.

RS 232C Interface: 9-pin subminiature socket connector
DIN 41652

Connector pin assignments

- Pin 2: TXD (transmit data)
- Pin 3: RXD (receive data)
- Pin 5: GND (ground)

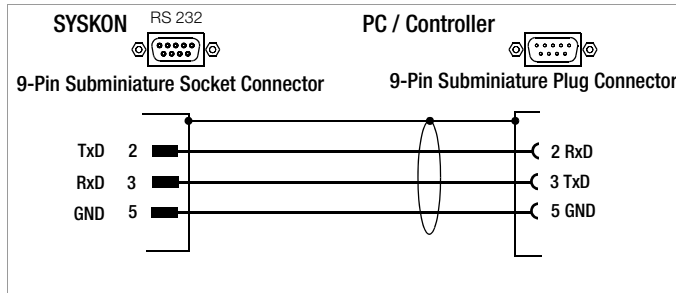

Figure 1: Connector Cable for Serial Interface

c) **GPIB or IEC Bus Interface (optional)**

This interface is optional and can be installed to the slot provided for this purpose on the rear panel.

IEEE 488/IEC 625 Interface Connection

24-pin IEEE 488 socket connector

IEEE 488/IEC 625 Interface Functions

- SH1 – SOURCE HANDSHAKE
- AH1 – ACCEPTOR HANDSHAKE
- T6 – TALKER
- L4 – LISTENER
- TE0 No extended talker function
- LE0 No extended listener function
- SR1 – SERVICE REQUEST
- RL1 – REMOTE / LOCAL
- DC1 – DEVICE CLEAR
- PP1 – PARALLEL POLL
- DT1 – DEVICE TRIGGER
- C0 – No controller function
- E1 / 2 – Open collector driver
- Codes / formats Per IEEE 488.2

2.3.7 Driver update (USB device driver)

We recommend a driver update in the following cases:

- Replacement purchases of devices (connecting new devices of the SYSKON range with a PC)
- retrofitting of interface cards
- firmware update
- software update

GMC-I Driver Control software can be downloaded from Gossen Metrawatt's website at:

<http://www.gossenmetrawatt.com>
 → Produkte → Software → Software for Testers
 → Dienstprogramme → **Driver Control**

The ZIP file can be unpacked in any desired directory. The setup file then appears in the directory. Installation is started by double clicking the setup file. A wizard guides you through the installation procedure.

2.3.8 Connecting the Analog Interface

The plug connection for the analog interface is located on the rear panel. Two 10-pin plug-in screw terminal connections are used to this end. The necessary connections for the selected analog control function can be made here. In order to keep cross interference with the analog signals to a minimum, it is advisable to use shielded connector cables. The individual signals are described under "Analog Interface".

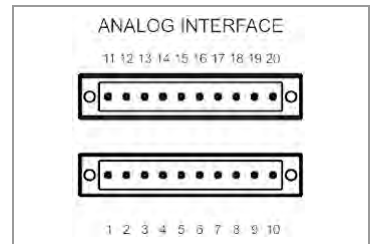

2.4 Switching the Device On

After the described preparations have been completed, the device can be switched on. The mains switch is located at the bottom left-hand side of the front panel.

Start-Up Routine

After switching the device on, the POWER lamp [4] lights up and the fan is started. The microprocessor included in the device then starts a power-up test. The following operations are performed during the test routine (duration approximately 6 seconds):

- Reset all functional units (except battery-backed configuration memory)
- LED and display segment test
- Hardware/firmware version display, see chapter 2.4.1
- Line voltage range is detected, see chapter 2.4.2
- Initialization of the 2 (possibly 3) computer interfaces; if the device has been equipped with the optional "IEEE 488 interface", the selected IEC bus device address then appears briefly at the display (example: "Addr 12"). See chapter 6 main menu level SETUP DISPLAY & INTERFACE for changing the device address.
- Date display (internal clock)
- Time display (internal clock)
- Recall last settings if applicable
- Switch to (default after "*RST") display of measured values for voltage (Uout) and current (Iout)

After initial power-up, the device is set to its basic default configuration (see the table entitled "Adjustable Functions and Parameters" in chapter 10.1).

Upon shipment from the factory, the device is configured such that the setpoints for output voltage and current are set to zero, and the power output is set to off.

For further use, status after power on depends upon the selected device configuration.

This configuration is selected either manually with the help of the corresponding menu item, or by means of the POWER_ON command.



Attention!

Avoid switching the device on and off in a rapid, repeated fashion. This temporarily impairs the effectiveness of the inrush current limiting function, and may result in a blown fuse.

2.4.1 Table of Firmware Versions

Firmware Version	Memory Locations
Version 003	12 SETUP memory locations 1536 SEQUENCE memory locations
Version 004	15 SETUP memory locations 1700 SEQUENCE memory locations

2.4.2 Response after Power ON with Varying Line Voltage Ranges (230 V ↔ 115 V)

Up to and including Firmware Version 004

After „Power ON“, a distinction is made - on the basis of the line voltage detected - between the two available power ranges. When the line voltage is „low“, output power P_{nom} is reduced by half (see chapter 4.1).

The specified value „PSET < P_{nom} “ (and/or „PSET < $P_{nenn}/2$ “ in the case of power derating), in turn, is the setting criterion for the function „Power control“. After an automatic change of P_{nom} it may be necessary to correct the PSET value for power control!

Power ON & Setting „Power_ON RST / SBY / RCL / ...“:

- „RST“ P_{nom} is always readjusted in accordance with the detected line voltage.
- „SBY“, „RCL“ A low line voltage always leads to a reduced P_{nom} value. If the device is subsequently switched on to a „high“ line voltage, the low P_{nom} value remains active until either:
 - a „RESET“ is performed (!)
 - or
 - „Power“ is reconnected with parameter setting „POWER_ON RST“.

Changes between the line voltage ranges result in system messages, see Err AC-L and Err AC-H in chapter 11.

As from Firmware-Version 005

After „Power ON“, a distinction is made - on the basis of the line voltage detected - between the two available power ranges.

When the line voltage is „low“, output power is limited to approximately 55 % of the nominal power.

If the device is switched on in setting „POWER_ON RST“ at „low“ line voltage, the setting limit value is reduced to half the nominal power for parameter PSET.

The specified value „PSET < P_{nom} “ (and/or „PSET < $P_{nenn}/2$ “ in the case of power derating), in turn, is the setting criterion for the function „Power control“.

Power ON & Setting „Power_ON RST / SBY / RCL / ...“:

- „RST“ P_{nom} is always readjusted in accordance with the detected line voltage.
- „SBY“, „RCL“ A low line voltage always leads to a reduced maximum output power. The setting limit values for parameter PSET, however, remain unchanged until either:
 - a memory recall of a corresponding device setting is performed
 - or
 - „Power“ is reconnected with parameter setting „POWER_ON RST“.

Changes between the line voltage ranges result in system messages, see Err AC-L and Err AC-H in chapter 11.

3 Technical Description

Description

SYSKON KONSTANTERs (power factor control, single-output system power supplies) are manual and remote controllable DC power supplies for laboratory and system use. Thanks to modern switching controller technology, the devices are compact and lightweight despite high output power.

Active power factor control assures nearly sinusoidal mains input current.

The floating output features "safety separation" from the mains input as well as from the computer interfaces, and is classified as a safety extra-low voltage circuit (SELV) in accordance with VDE / IEC. Wide ranging nominal output power values are available from output voltage and output current.

The power output is voltage and current controlled with limiting to maximum withdrawable power.

Transition to the control modes is automatic in accordance with the selected setpoints and load circumstances.

The control loops are designed for short response times.

An automatically activated, dynamic sink (can be disabled) provides for quick discharging of the output capacitors.

Numerous protective functions and monitoring devices allow for ideal adaptation to actual conditions of use.

Features

The devices are generally equipped with a control panel and display, as well as an analog interface.

One USB port and one RS 232 interface are provided as standard equipment for integration into computer controlled systems. The drivers for the USB port are provided as accessories on the included CD ROM.

An IEEE 488 interface can be additionally installed to the device from the outside, or retrofitted as an option.

Manual adjustment of voltage and current is accomplished by means of two rotary encoders with selectable resolution, or with the numeric keypad. Numerous additional functions can be accessed via keys.

Two 5-place digital LED displays read out measured values and settings. LEDs indicate the current operating mode, selected display parameters and the status of device and interface functions.

The analog interface makes it possible to adjust output voltage and current with the help of external control voltages. Monitor outputs read out an analog image of the voltage and current output quantities for further processing or additional displays. These control inputs and monitor outputs can also be used to couple several devices for master-slave operation with parallel or series connection.

Two floating trigger inputs are available for controlling certain device functions. For example, they can be used to switch the output on and off, or to control sequences.

Furthermore, three signal outputs are included at the analog interface, two of which are floating. These can be activated depending upon various functions, and can thus be used to control external devices or sequences.

Applications Range

Konstanters are suitable for use wherever electronic modules with controlled direct voltage or controlled current need to be supplied with electrical power, especially in the fields of R&D, testing, production, test systems and training.

Thanks to their characteristic U-I-P curve, the devices have a broad working range, making it possible to cover a large range of applications with a single device.

Due to their short response times, SYSKON KONSTANTERs can be used for replication and simulation of onboard electrical systems, for example in automotive applications. Test signals specified in the corresponding standards can be generated. The fact that these voltage-current-time profiles can be saved to memory at the Konstanter for running independent sequences is highly advantageous. When used in test systems, it is thus possible to significantly reduce workload for the control computer. Further functions for test applications of this sort include the Min-Max function for acquiring extreme values and the tolerance band function which generates a signal when measured values do not lie within the specified tolerance limits.

The Konstanter thus serves as an autonomous test system for many applications.

Adjustable Functions (selection)

- Voltage and current setpoint values
- Voltage and current limit values (soft-limits)
- Activate / deactivate the output
- Overvoltage protection trigger value (OVP)
- Overcurrent protection trigger value (OCP)
- Delay time for reaction to overvoltage
- Selection of the desired reaction when OVP and OCP are triggered
- Delay time for reaction to overcurrent
- Performance after power on
- Reset device settings
- Save device settings
- Recall device settings, individually or sequentially
- Function selection for trigger input
- Configurable status and events management with enabling windows (via computer interface)
- Activate / deactivate digital displays

Retrievable Information (selection)

- Presently measured voltage and current values
- Minimum and maximum measured voltage and current values
- Current output power
- Current device settings
- Current device status (i.e. control mode, overtemperature etc.)
- Occurred events (i.e. mains failure, overtemperature, overvoltage, overload etc.)
- Device ID (via computer interface)

Protection and Additional Functions

- Sensor terminals protected against polarity reversal and automatic switching to auto-sensing
- Protection against excessive temperature
- Output protected against reverse polarity
- Front panel control disabling
- Backup battery for device settings memory
- Recognition of mains or phase failure
- Inrush current limiting

Performance After Power on

In the event of mains failure, it's important to specify which operating state the device will assume when power is restored. This may be extremely important if the device is used in long-term testing applications.

One of the following states can be selected:

- Reset = default setting (0 V, 0 A, output deactivated)
- Standby= last used configuration but with deactivated output
- Recall = last used configuration – same as when the instrument was last switched off, with active output if it was active prior to mains failure
- Recall a device configuration from setup memory

Set Output Voltage and Output Current

Output voltage and output current can also be adjusted using the rotary encoders or the numeric keypad if desired. The rotary encoders are used exclusively for adjusting voltage and current. The decimal place to be changed is selected with the scroll keys. Additional functions and parameters can be accessed and adjusted with the keys.

Switching the Input On and Off

The power output can be switched on and off by pressing the appropriate key, with a computer command or by applying a signal to the trigger input. When switched off, the output is highly resistive and is not electrically isolated from the power consumer. The LED on the key indicates status.

Protection and Additional Functions

A multitude of protection and additional functions have been integrated, for example:

- Limiting of the setting ranges for voltage and current
- Overvoltage protection (OVP) with adjustable response delay and reaction
- Overcurrent protection (OCP) with adjustable response delay and reaction
- Protection in the event of reversed polarity at the sensing leads
- Automatic switching to auto-sensing
- Protection against excessive temperature
- Output protected against reverse polarity
- Front panel control disabling
- Backup battery for device settings memory
- Mains failure detection
- Inrush current limiting
- Line voltage monitoring

Line Voltage Monitoring

To protect the device, power output is deactivated and disabled in the event of voltage dips or short-term interruptions. The device must be restarted with „Power ON“.

Dynamic Sink

A dynamic sink is activated by the control loops as required for rapid discharging of the output capacitors.

This allows for short response times when switching to smaller setpoint values. Depending upon the application, the sink function can also be disabled.

Auto-Sensing

The device can be switched to sensing mode operation (remote sensing) in order to compensate for voltage drop at the output leads. Sensing lead terminals are available to this end at the analog interface. If the (–) negative sensing terminal is connected to the negative load point, the device is automatically switched to sensing mode operation. Maximum compensatable voltage drop is 1 V per output lead.

Front Panel Control Disabling

The controls can be disabled to prevent unauthorized operation by pressing the appropriate key, with a computer command or by applying a signal to the trigger input.

Analog Control Inputs

Voltage and current can also be adjusted by via the control inputs at the analog interface. A 5 V signal corresponds to 100% of the respective nominal value.

These inputs can be switched on and off using the keys, or with computer commands.

The controlled output quantity is the sum of the digital setpoint value and the specified value at the control input.

This function makes it possible to superimpose these control signals onto the output quantities.

Monitor Outputs

The actual values for output voltage and current can be acquired at the monitor outputs as a standardized signal (10 V corresponds to 100% nominal value).

Trigger Inputs

Two floating trigger inputs are available for controlling device functions. The following trigger input assignments can be selected:

- output = Switch the power output on and off
- local lock = Disable controls
- SQS = (sequence step) Step-by-step control of a stored sequence
- sequence = Start / stop the sequence function
- Analog input = Activate / deactivate the analog control inputs

Signal Outputs

Programmable Control Outputs

The analog interface is equipped with three digital control outputs for status messages to external monitoring devices, for switching external components on and off, or for coupling purposes.

The status of these outputs can be defined either directly, or depending upon the following device statuses:

- Output on or off
- Voltage or current regulation
- Sequence function running or finished
- SSET signal status for the sequence function
- Limit value message for the measuring function (tolerance band)

Min-Max Measured Value Memory

The Min-Max function automatically acquires and saves minimum and maximum voltage and current values.

Tolerance Band (in combination with Min-Max function)

Measured output values can be continuously compared with stored upper and lower tolerance band values. Evaluation is possible via the programmable control outputs.

Memory

The memory function makes it possible to save and recall device configurations using a battery-backed memory module.

The memory module is equipped with two storage areas:

- Setup memory: 12/15 memory locations for complete configurations
- Sequence memory: 1536/1700 memory locations for the following sequence parameters: voltage setpoint USET, current setpoint ISET, dwell time TSET and function request FSET, with the ability to invoke subsequences

Sample Application

Generation of a characteristic voltage curve in an automotive electrical system when starting the engine

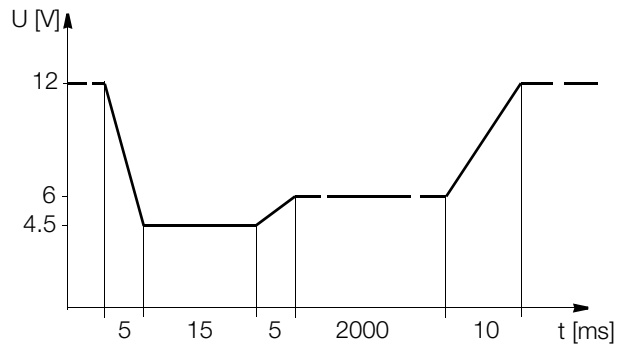

Note:

The drop times can be influenced by the input impedance of the DUT.

Balancing Function (adjust)

Offset and final values for setting and measured values for output quantities voltage and current are balanced digitally in the device. The user can execute balancing as required with this function.

DAkKS Calibration Certificate

All SYSKON Konstanters are shipped with a DAkKS calibration certificate issued by our DAkKS test laboratory.

4 Technical Data

4.1 General Data

Output Operating Ranges, Characteristic U-I-P Curve SYSKON P500

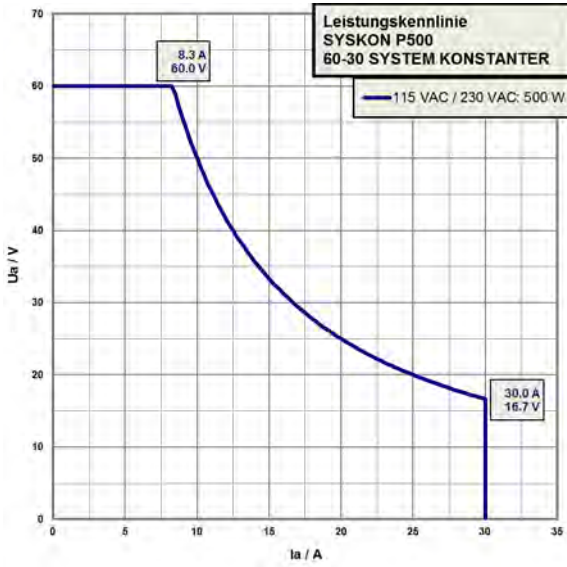

Output Operating Ranges, Characteristic U-I-P Curve SYSKON P3000

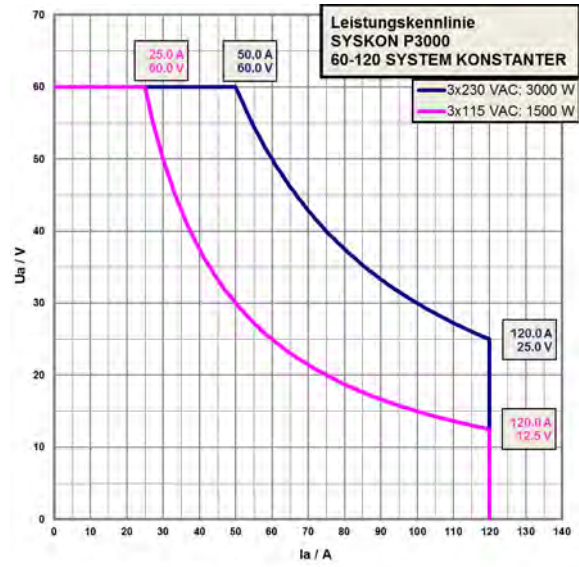

Output Operating Ranges, Characteristic U-I-P Curve SYSKON P800

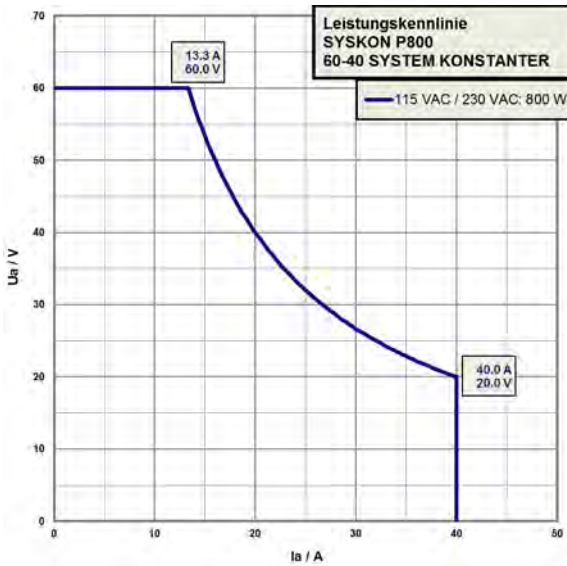

Output Operating Ranges, Characteristic U-I-P Curve SYSKON P4500

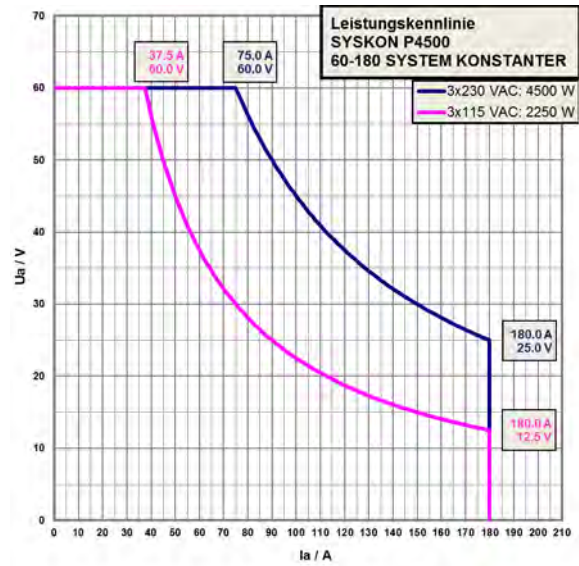

Output Operating Ranges, Characteristic U-I-P Curve SYSKON P1500

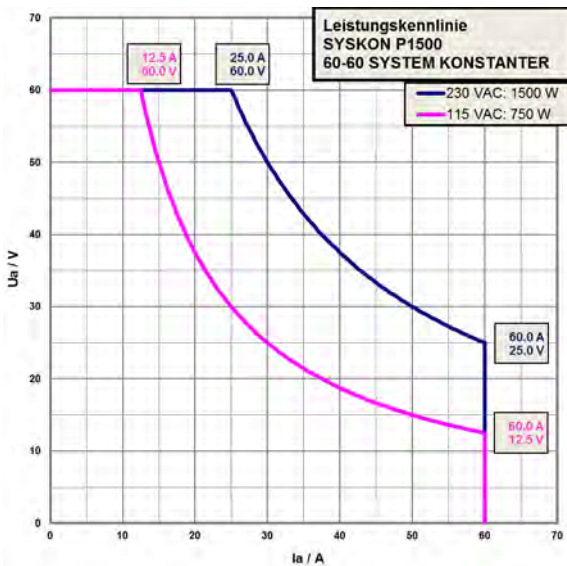

Output

Regulator type	Primary switched-mode regulator
Operating modes	Adjustable constant voltage / constant current source with automatic sharp transition
Output insulation	Floating output with "safe electrical separation" from the mains input and computer interfaces
Allowable potential, output-ground	Max. 240 V DC
Capacitance, output-ground (housing)	
SYSKON P500	typically 1000 nF
SYSKON P800	typically 1000 nF
SYSKON P1500	typically 1000 nF
SYSKON P3000	typically 1000 nF
SYSKON P4500	typically 1000 nF

Analog Interface

Functions	<ul style="list-style-type: none">– Auto-sensing mode– 2 programmable trigger inputs– 3 programmable signal outputs– Voltage control input (0 ... 5 V)– Current control input (0 ... 5 V)– Voltage monitor output (0 ... 10 V)– Current monitor output (0 ... 10 V)– Master-slave parallel operation– Master-slave series operation– Auxiliary power output: 15 V / 60 mA
-----------	--

Computer Interfaces

- IEC-625 / IEEE 488 interface (optional)

 - RS 232 interface
- | | |
|--------------------|----------------------------------|
| Transmission mode | asynchronous |
| Transmission speed | 1200 to 115,200 baud, adjustable |
- USB port
- | | |
|---------------------------|----------------------------------|
| USB port: | 4-pin, type B |
| USB 1.1 compatible with | USB 2.0 |
| Connector pin assignments | 1: VCC, 2: D-, 3: D+, 4: GND |
| Transmission speed | 9600 to 115,200 baud, adjustable |

Power supply

Line voltage	115/230 V ~ + 10 / – 15%; 47 to 63 Hz
Inrush current	Max. 50 A _s
Mains fuse	SYSKON P500/P800/P1500: 1 x M 15 A / 250 V (6.3 x 32 mm), UL SYSKON P3000/4500: 3 x M15 A/250 V

Electrical Safety

Safety class	I
Measuring category	II for mains input I for output and interfaces
Fouling factor	2
Earth leakage current	< 2.5 mA _{RMS}

Electrical isolation	Test voltage
Output – mains	2.2 kV ~
Output – bus/ground	1.4 kV ~
Mains – bus/ground	2.2 kV –
Bus – ground	No electrical isolation

Applicated Standards

IEC 61010-1:2010
DIN EN 61010-1:2010
VDE 0411-1:2011
EN 61326

4.1.1 Electromagnetic Compatibility

SYSKON P500/P800/P1500

Generic standard	EN 61326-1: October 2006
Interference emission	EN 55022: class B
Interference immunity	EN 61000-4-2: feature A EN 61000-4-3: feature B EN 61000-4-4: feature A EN 61000-4-5: feature A EN 61000-4-6: feature A EN 61000-4-8: feature A EN 61000-4-11: feature A

SYSKON P3000/4500

Generic standard	EN 61326-1: October 2006
Interference emission	EN 55022: class A *
Interference immunity	EN 61000-4-2: feature B EN 61000-4-3: feature A EN 61000-4-4: feature B EN 61000-4-5: feature B EN 61000-4-6: feature A EN 61000-4-8: feature A EN 61000-4-11: feature B

* Note:

Approved for the deployment in industrial environment. The device may cause radio interferences in domestic areas.

4.1.2 Ambient Conditions

Temperature range	Operation: 0 to 40° C Storage: –25 to +75° C
Atmospheric humidity	Operation: ≤ 75% rel. humidity, no condensation allowed Storage: ≤ 65% rel. humidity
Cooling	With integrated fan (temperature controlled) Inlet vent: Side panel Outlet vent: Rear panel
Operating noise	Noise pressure level at a distance of 30 cm with fan set to low / high Front 17 / 28 dBA Rear 22 / 32 dBA Left 17 / 28 dBA Right 20 / 31 dBA

4.2 Mechanical Data

Protection IP 00 for device and interface connections
IP 20 for housing

Table Excerpt Regarding Significance of IP Codes

IP XY (1 st char. X)	Protection against penetration by solid particles	IP XY (2 nd char. Y)	Protection against penetration by water
0	Not protected	0	Not protected
1	≥ 50.0 mm dia.	1	Vertical dripping
2	≥ 12.5 mm dia.	2	Dripping (15° inclination)

Design Benchtop device, suitable for installation to 19" cabinets

Article No.	Designation	Dimensions (W x H x D)	Weight
K346A	SYSKON P500-060-030	19" x 2 HE 447 x 102 (88) x 541 (501) mm	10 kg
K347A	SYSKON P800-060-040	19" x 2 HE 447 x 102 (88) x 541 (501) mm	10 kg
K353A	SYSKON P1500-060-060	19" x 2 HE 447 x 102 (88) x 541 (501) mm	10 kg
K363A	SYSKON P3000-060-120	19" x 4 HE 447 x 191 (177) x 541 (501) mm	16 kg
K364A	SYSKON P4500-060-180	19" x 4 HE 447 x 191 (177) x 541 (501) mm	20 kg
K384A	IEEE 488 interface (optional)		Approx. 0.14 kg

HE = standard height units

4.2.1 Terminals (rear panel)

Mains input SYSKON P1500:
10 A IEC inlet plug with earthing
contact (L + N + PE)

SYSKON P3000/4500:
Connection terminals (min. 16 A)
(L1 + L2 + L3 + N + PE)

Output SYSKON P1500:
Terminal blocks with thread for
M6 screws and 4 mm dia. holes

SYSKON P3000/4500:
Terminal blocks with thread for M8 and M6
screws and 4 mm dia. holes

Analog interface /
sensing leads Double-row plug connector
with two 10-pole screw terminals

4.3 Electrical Data

Article Number			K346A	K347A	K353A
Type			SYSKON P500-060-030	SYSKON P800-060-040	SYSKON P1500-060-060
Nominal Output Data			Voltage setting range Current setting range Power	0 ... 60 V 0 ... 40 A max. 800 W	0 to 60 V 0 to 60 A Max. 1500 W
Output Characteristics (ppm and percentage values make reference to the respective setting or measured value)					
Setting resolution			Voltage Current	1 mV 1 mA	1 mV 1 mA
Setting accuracy (at 23 ± 5 °C)			Auto-sensing mode Without auto-sensing	Voltage Current	0.05 % + 30 mV 0.05 % + 48 mV 0.05 % + 90 mA 0.05 % + 30 mV 0.05 % + 48 mV 0.05 % + 90 mA
Temperature coefficient for Δ / K setting			Voltage Current	100 ppm 100 ppm	100 ppm 100 ppm
Setting accuracy via analog interface (at 23 ± 5 °C) $U_{\text{setnom}}/U_{\text{setanalog}} = 12$; $I_{\text{setnom}}/I_{\text{setanalog}} = 12/24/36$			Voltage Current	0.6 % + 120 mV 0.6 % + 120 mA	0.6 % + 120 mV 1.2 % + 120 mA
Static system deviation at 100% load fluctuation			Auto-sensing mode Without auto-sensing	Voltage Current	30 mV (< 500 μV/A) 48 mV (< 800 μV/A) 30 mA (< 500 μA/V) 30 mV (< 500 μV/A) 48 mV (< 800 μV/A) 30 mA (< 500 μA/V)
Static system deviation with 10% line voltage fluctuation			Voltage Current	5 mV 5 mA	5 mV 5 mA
Residual ripple			Voltage Current	Ripple: 10 Hz to 20 kHz Ripple: 10 Hz to 1 MHz Ripple + noise: 10 Hz to 10 MHz Ripple + noise: 10 Hz to 10 MHz 40 mV _{SS} 50 mV _{SS} 60 mV _{SS} / 6 mV _{eff} 50 mA _{eff}	40 mV _{SS} 50 mV _{SS} 60 mV _{SS} / 6 mV _{eff} 50 mA _{eff}
Output voltage transient recovery time with sudden load variation within range of 20 to 100% I _{nom} and 20 to 100% U _{nom}			Tolerance ΔI = 10% ΔI = + 80% + approx. 800 A/ms ΔI = - 80% + approx. 1200 A/ms	120 mV 100 μs 600 μs 950 μs	120 mV 100 μs 500 μs 650 μs
Output voltage over and undershooting with sudden load variation within a range of 20 to 100% I _{nom} and 20 to 100% U _{nom}			ΔI = 10% ΔI = 80%	150 mV 500 mV	150 mV 700 mV
Setting time for output voltage ¹⁾ where U _{set} step = 0 V → 60 V where U _{set} step = 60 V → 1 V where U _{set} step = 0 V → 25 V where U _{set} step = 25 V → 1 V			Tolerance No-load; nominal load ²⁾ No-load; nominal load ²⁾ No-load; nominal load ²⁾ No-load; nominal load ²⁾	120 mV 2 ms / 2 ms 70 ms / 20 ms 1.4 ms / 1.4 ms 16 ms / 5 ms	120 mV 2 ms / 2 ms 70 ms / 15 ms 1.4 ms / 1.4 ms 16 ms / 3 ms
Output capacitor Sink (continuous power)			Nominal value Power	2020 μF 40 W – 65 W	2020 μF 40 to 65 W
Measuring Function					
Measuring Range			Voltage Current Power	- 16.384 ... + 98.300 V - 32.766 ... + 98.300 A U x I	- 16.384 to + 98.300 V - 2.766 to + 98.300 A U x I
Measuring resolution			Voltage Current Power	2 mV 2 mA 100 mW	2 mV 2 mA 100 mW
Measuring accuracy (at 23 ± 5 °C)			Voltage Current Power	0.05 % + 30 mV 0.4 % + 90 mA 0.5 % + 1 W	0.05 % + 30 mV 0.4 % + 90 mA 0.5 % + 1 W
Measured value temperature coefficient Δ / K			Voltage Current	50 ppm + 0.4 mV 100 ppm + 1 mA	0.4 mV + 50 ppm 1 mA + 100 ppm
Measuring accuracy (at 23 ± 5 °C) at analog interface $U_{\text{actualnom}}/U_{\text{actualanalog}} = 6$; $I_{\text{actualnom}}/I_{\text{actualanalog}} = 6/12/18$			Voltage Current	0.4 % + 120 mV 0.5 % + 180 mA	0.4 % + 120 mV 1.2 % + 180 mA
Protection and Additional Functions					
Output overvoltage protection			Trigger value Setting Range Setting resolution Setting accuracy	3 ... 80 V 20 mV ±150 mV - 10 mΩ x I _a 200 μs	3 to 80 V 20 mV ±150 mV - 20 mΩ x I _a 200 μs
Output overcurrent protection			Trigger value Setting Range Setting resolution Setting accuracy	1.5 ... 40 A 20 mA 20 mA -(1% + 350 mA) - 20 mA/V x U _a	3 to 80 A 20 mA 20 mA -(1% + 350 mA) - 20 mA/V x U _a
Reverse polarity protection load capacity			Continuous	30 A	60 A
Reverse voltage withstand capacity			Continuous	70 V -	70 V -
Auto-sensing mode Compensatable voltage drop			Per output lead	1 V	1 V
General					
Power supply with 230 V~ nominal line voltage Power consumption			Line voltage At nominal load, 100% At no load	230 V~ + 10 / - 15 %, 47 ... 63 Hz 700 VA; 650 W 96 VA; 37 W	230 V~ + 10 / - 15 %, 47 ... 63 Hz 1050 VA; 1000 W 96 VA; 37 W
Power supply with 115 V~ nominal line voltage Power consumption			Line voltage At nominal load, 50% At no load	115 V~ + 10 / - 15 %, 47 ... 63 Hz 800 VA; 750 W 55 VA; 36 W	115 V~ + 10 / - 15 %, 47 to 63 Hz 1125 VA; 1100 W 55 VA; 36 W
Max. power loss			At a nominal load 500 W/800 W/1500 W (230 V~) At a nominal load 500 W/800 W/750 W (115 V~)	150 W 250 W	365 W 350 W
Efficiency			At a nominal load 500 W/800 W/1500 W (230 V~) At a nominal load 500 W/800 W/750 W (115 V~)	77 % 66 %	80% 68%
Switching frequency, PFC / DC/DC			Typical	47 kHz / 230 kHz	47 kHz / 230 kHz
Inrush current			Max.	50 A _s	50 A _s
Mains fuse (6.3 x 32 mm, UL)				1 x M 15 A / 250 V	1 x M 15 A / 250 V
MTBF (mean time between failures)			at 40 °C	> 50,000 h	> 50,000 hours

¹⁾ at maximum current setting not including processing time for the previous voltage setting command

²⁾ Nominal load: Rload = Uset² / Pnom

Article Number		K363A	K364A
Type		SYSKON P3000-060-120	SYSKON P4500-060-180
Nominal Output Data		Voltage setting range Current setting range Power	0 ... 60 V 0 ... 120 A max. 3000 W
		0 ... 60 V 0 ... 180 A max. 4500 W	
Output Characteristics (ppm and percentage values make reference to the respective setting or measured value)			
Setting resolution		Voltage Current	1 mV 3.125 mA
Setting accuracy (at 23 ± 5 °C)	Auto-sensing mode	Voltage	0.07 % + 48 mV
	Without auto-sensing	Voltage Current	0.07 % + 60 mV 0.1 % + 135 mA
Temperature coefficient for Δ / K setting		Voltage Current	100 ppm 100 ppm
		Voltage Current	100 ppm 100 ppm
Setting accuracy via analog interface (at 23 ± 5 °C) $U_{setnom}/U_{setanalog} = 12$; $I_{setnom}/I_{setanalog} = 12/24/36$		Voltage Current	0.6 % + 150 mV 1.2 % + 180 mA
Static system deviation at 100% load fluctuation	Auto-sensing mode	Voltage	60 mV (< 500 μV/A)
	Without auto-sensing	Voltage Current	90 mV (< 500 μV/A) 144 mV (< 800 μV/A) 90 mA (< 1500 μA/V)
Static system deviation with 10% line voltage fluctuation		Voltage Current	7 mV 30 mA
		Voltage Current	10 mV 60 mA
Residual ripple	Voltage	Ripple: 10 Hz to 20 kHz Ripple: 10 Hz to 1 MHz Ripple + noise: 10 Hz to 10 MHz	60 mV _{SS} 75 mV _{SS} 90 mV _{SS} / 10 mV _{eff}
	Current	Ripple + noise: 10 Hz to 10 MHz	70 mA _{eff} 120 mV 500 μs 1600 μs 2500 μs
Output voltage transient recovery time with sudden load variation within range of 20 to 100% I _{nom} and 20 to 100% U _{nom}		Tolerance ΔI = 10% ΔI = + 80% + approx. 800 A/ms ΔI = - 80% + approx. 1200 A/ms	120 mV 400 μs 1200 μs 1900 μs
Output voltage over and undershooting with sudden load variation within a range of 20 to 100% I _{nom} and 20 to 100% U _{nom}		ΔI = 10% ΔI = 80%	200 mV 1200 mV
Setting time for output voltage ¹⁾ where U _{set} step = 0 V → 60 V where U _{set} step = 60 V → 1 V		Tolerance No-load; nominal load ²⁾ No-load; nominal load ²⁾	120 mV 4 ms / 15 ms 70 ms / 11 ms
		No-load; nominal load ²⁾ No-load; nominal load ²⁾	1.2 ms / 6 ms 16 ms / 6 ms
Output capacitor Sink (continuous power)		Nominal value Power	4040 μF 80 W – 130 W
		Nominal value Power	6060 μF 120 W – 195 W
Measuring Function			
Measuring Range		Voltage Current Power	- 16.384 ... + 98.300 V - 65.532 ... + 196.600 A U x I
		Voltage Current Power	- 16.384 ... + 98.300 V - 98.298 ... + 294.900 A U x I
Measuring resolution		Voltage Current Power	2 mV 4 mA 100 mW
		Voltage Current Power	2 mV 6 mA 100 mW
Measuring accuracy (at 23 ± 5 °C)		Voltage Current Power	0.07 % + 48 mV 0.6 % + 120 mA 0.7 % + 2 W
		Voltage Current Power	0.1 % + 48 mV 0.8 % + 180 mA 1 % + 3 W
Measured value temperature coefficient Δ / K		Voltage Current	50 ppm + 0.6 mV 100 ppm + 2 mA
		Voltage Current	50 ppm + 0.8 mV 100 ppm + 3 mA
Measuring accuracy (at 23 ± 5 °C) at analog interface $U_{actualnom}/U_{actualanalog} = 6$; $I_{actualnom}/I_{actualanalog} = 6/12/18$		Voltage Current	0.6 % + 180 mV 1.2 % + 240 mA
		Voltage Current	0.8 % + 180 mV 1.2 % + 300 mA
Protection and Additional Functions			
Output overvoltage protection	Trigger value	Setting Range Setting resolution Setting accuracy	3 ... 80 V 20 mV ±150 mV - 20 mΩ x I _a
	Response time		200 μs
Output overcurrent protection	Trigger value	Setting Range Setting resolution Setting accuracy	6 ... 160 A 50 mA -(1% + 500 mA) - 40 mA/V x U _a
	Response time		200 μs
Reverse polarity protection load capacity		Continuous	120 A
Reverse voltage withstand capacity		Continuous	70 V -
Auto-sensing mode Compensatable voltage drop		Per output lead	1 V
		Per output lead	1 V
General			
Power supply with 230 V~ nominal line voltage Power consumption	Line voltage	3x230/400 V~ + 10 / - 15 %	3x230/400 V~ + 10 / - 15 %
	At nominal load, 100% At no load	47 ... 63 Hz 3810 VA; 3710 W 100 VA; 45 W	47 ... 63 Hz 5660 VA; 5500 W 110 VA; 55 W
Power supply with 115 V~ nominal line voltage Power consumption	Line voltage	3x115/200 V~ + 10 / - 15 %	3x115/200 V~ + 10 / - 15 %
	At nominal load, 50% At no load	47 ... 63 Hz 2215 VA; 2180 W 73 VA; 48 W	47 ... 63 Hz 3305 VA; 3255 W 92 VA; 60 W
Max. power loss	At a nominal load 3000 W/4500 W (230 V~)	710 W	1100 W
	At a nominal load 1500 W/2250 W (115 V~)	680 W	1030 W
Efficiency	At a nominal load 3000 W/4500 W (230 V~)	81 %	82 %
	At a nominal load 1500 W/2250 W (115 V~)	69 %	69 %
Switching frequency, PFC / DC/DC		Typical	47 kHz / 230 kHz
Inrush current		Max.	50 A _s
Mains fuse (6.3 x 32 mm, UL)			3 x M 15 A / 250 V
MTBF (mean time between failures)		at 40 °C	> 40,000 hours
			> 30,000 hours

¹⁾ at maximum current setting not including processing time for the previous voltage setting command

²⁾ Nominal load: Rload = Uset² / Pnom

4.3.1 Reference Conditions

Ambient temperature	23 °C ±2 K
Relative humidity	40 ... 60 %
Warm-up time	30 minutes

Output operating characteristics (ppm and percentage specifications refer to the respective setting and/or measured value)

5 Controls, Display Elements and Terminals

5.1 Front Panel SYSKON P500 / P800 / P1500

Control Mode Status Display

- CV** LED lights up Constant voltage regulating mode: $U_{out} \approx U_{set}$
LED Plim / CP* lights up **yellow**: $P_{out} > P_{nom}$ (OL) **green***: $P_{set} < P_{nom}$ progr. (CP)
CC LED lights up Constant current regulating mode: $I_{out} \approx I_{set}$

Protective Functions and Status Displays

- OTP/OVP** LED lights up Overtemperature protection triggered or output voltage ≥ 80 V exceeded, \Rightarrow OUTPUT = off
OVP LED lights up Overvoltage detection triggered, ΔU_{set} and ΔU_{dly} parameter values exceeded (prerequisite: ΔU_P parameter = on) \Rightarrow OUTPUT = off
OCP LED lights up Overcurrent detection triggered, ΔI_{set} and ΔI_{dly} parameters exceeded (prerequisite: ΔI_P parameter = on) \Rightarrow OUTPUT = off
OVP ON LED lights up Overvoltage shutdown is activated (ΔU_P parameter in device setup menu = on)
OCP ON LED lights up Overcurrent shutdown is activated (ΔI_P parameter in device setup menu = on)

Events

Settings

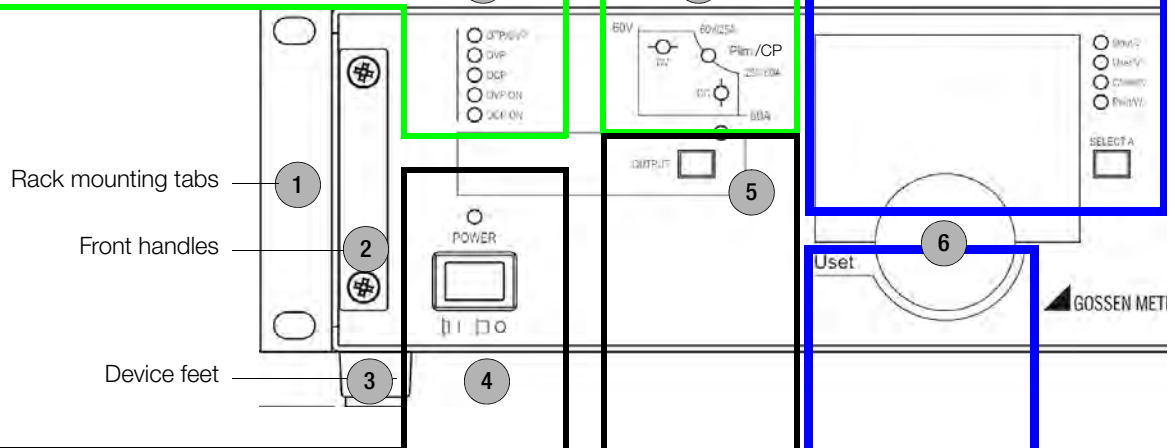

Display A

Standard display: measured voltage value U_{out} , display function is changed by pressing the SELECT A key or by turning the rotary knob. Adjust resolution (select decimal place) with the < and > scroll keys

Select A

Display selection:
 $U_{out} \rightarrow U_{set} \rightarrow OV_{set} \rightarrow P_{set}$

Mains Switch

- POWER** LED lights up Device is switched on
POWER switch Switches the device on and off

Power Output On/Off Key

- OUTPUT** LED lights up Output is active
OUTPUT switch Switches the power output on and off

Rotary Encoder for Voltage

Voltage setpoint U_{set} – adjust output voltage U_{set}

Condition: UL_L (lower setting limit) $\leq U_{set} \leq UL_H$ (upper setting limit)

When the rotary encoder is activated the display is switched to U_{set} (LED) and the cursor becomes active – the selected decimal place blinks at the display and can be selected with the < and > scroll keys.

The new setpoint becomes effective immediately.

Uset adjusting alternatives Activate by turning the rotary encoder, or select with Select A Uset

Scroll keys	< >: select decimal place	$\Delta \nabla$: immediately increase or reduce U_{set}
Numeric keypad	Entry of numeric values, U_{set} LED blinks	Execute with \downarrow , or abort with ESC

* valid as from revision level 02 and firmware version 004. In the case of hardware revision level < 02, the LED lights up yellow in both cases.

Display B

Standard display: measured current value
 out, display function is changed by pressing the SELECT A key or by turning the rotary knob. Adjust resolution (select decimal place) with the < and > scroll keys.

Select B

Display selection:
 Iout → Iset → OCset → Pout

Status Displays

TRG1 LED lights up Trigger signal 1 is active
TRG2 LED lights up Trigger signal 2 is active
Uext ON LED lights up Voltage input via analog interface is active
Iext ON LED lights up Current input via analog interface is active
M/S LED lights up Master-slave function

Device Status Displays

REMOTE LED lights up Remote control is active
ADDR/DATA LED lights up Addressing / data transmission is active
SRQ/ERR LED lights up Service request / error
LCL LOCKED LED lights up Control panel is disabled
SEQ STS LED lights up Sequence function in HOLD status
 blinks Sequence is active (RUN)

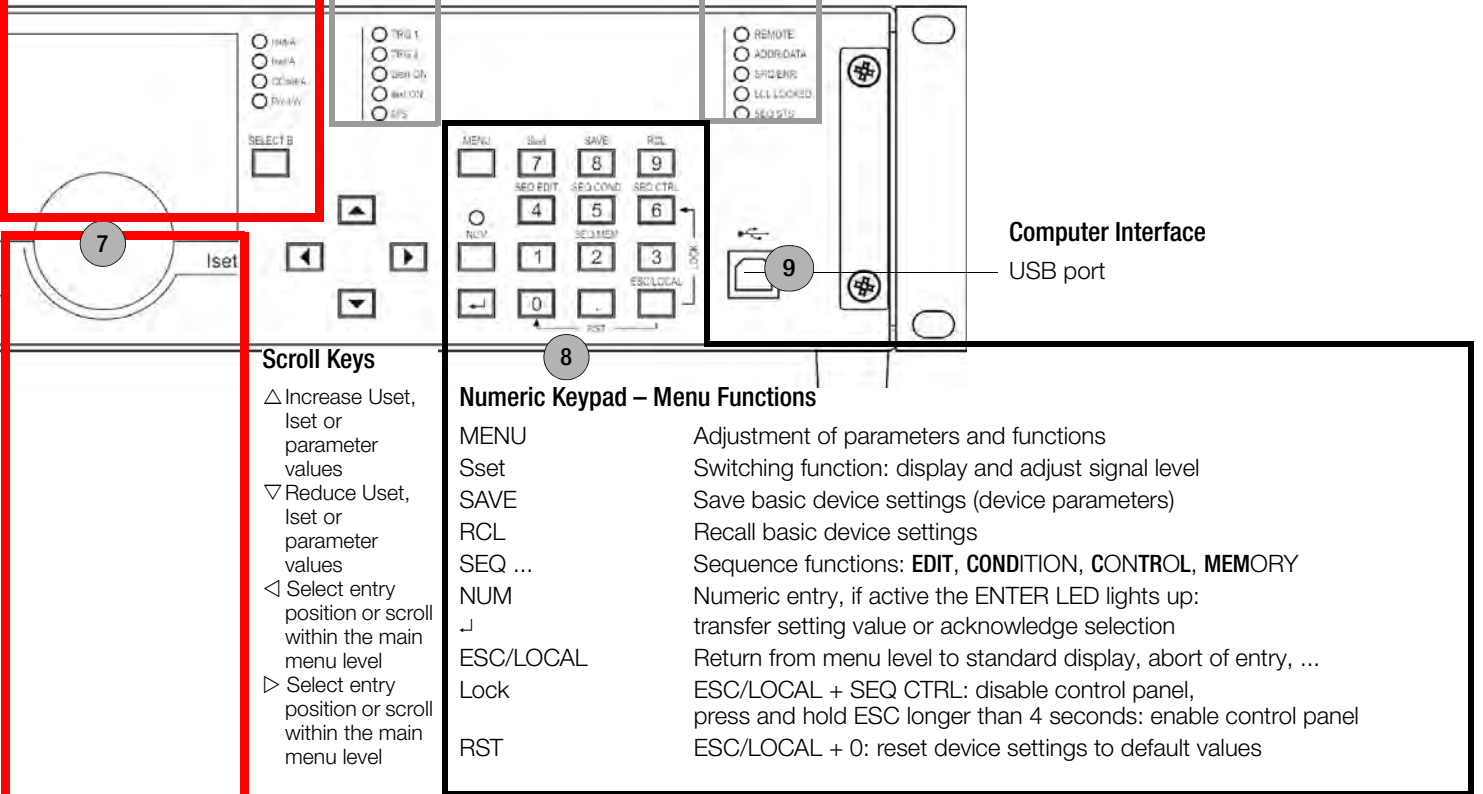

Scroll Keys

- △ Increase Uset, Iset or parameter values
- ▽ Reduce Uset, Iset or parameter values
- < Select entry position or scroll within the main menu level
- > Select entry position or scroll within the main menu level

Numeric Keypad – Menu Functions

MENU Adjustment of parameters and functions
Sset Switching function: display and adjust signal level
SAVE Save basic device settings (device parameters)
RCL Recall basic device settings
SEQ ... Sequence functions: **EDIT, CONDITION, CONTROL, MEMORY**
NUM Numeric entry, if active the ENTER LED lights up: transfer setting value or acknowledge selection
↵ Return from menu level to standard display, abort of entry, ...
ESC/LOCAL ESC/LOCAL + SEQ CTRL: disable control panel, press and hold ESC longer than 4 seconds: enable control panel
Lock ESC/LOCAL + 0: reset device settings to default values
RST

Rotary Encoder for Current

Current setpoint Iset – adjust output current setpoint

Condition: IL_L (lower setting limit) \leq Iset \leq IL_H (upper setting limit)

When the rotary encoder is activated, the display is switched to Iset (LED) and the cursor becomes active – the selected decimal place blinks at the display and can be selected with the < and > scroll keys The new setpoint becomes effective immediately.

Iset adjusting alternatives	Activate by turning the rotary encoder, or select with Select B Iset	
Scroll keys	< >: select decimal place	△ ▽: immediately increase or reduce Iset
Numeric keypad	Entry of numeric values, Uset LED blinks	Execute with ↵, or abort with ESC

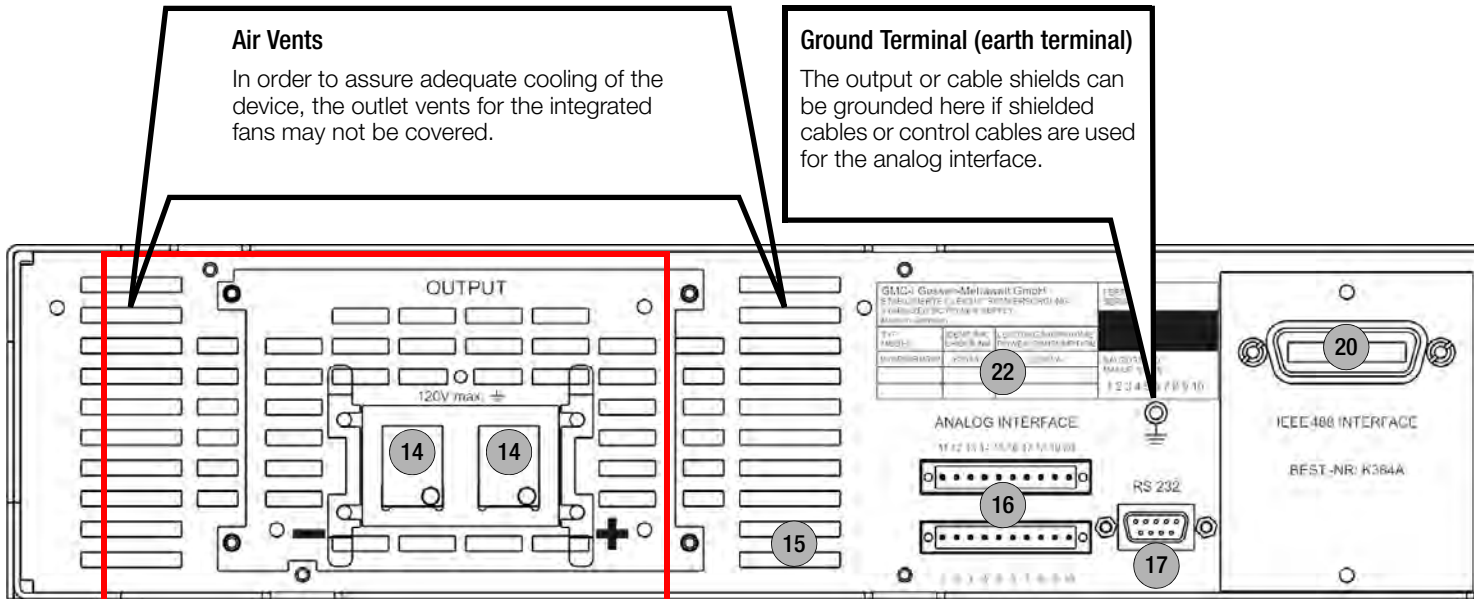

14
Power Output

Terminals for connecting the power consumer. This is a floating output and can be grounded with the positive or the negative pole.

Output connections may only be connected and disconnected when the output is inactive (OUTPUT OFF)! Danger of arcing!



Connecting the Power Consumer

The output leads are connected to the terminal blocks by means of ring-type cable lugs with the included M6 x 10 screws. Measurement cables can be additionally connected to the 4 mm holes.

- Remove the safety cap.
- Connect the output leads to the terminal blocks with the provided screws and washers.
- An adequate wire cross-section and correct polarity must be assured. It is advisable to twist the output leads and to identify polarity at both ends.
- Avoid exerting excessive force at the terminals.
- Align the leads to the openings in the safety cap.
- Snap the safety cap back into place.



In order to prevent danger during use, shock-proof connector cables must be used when connecting power consumers.

16
Analog Interface (X13)

- Remote control for output voltage and current
- External measurement of output voltage and current
- Connection of sensing leads in order to compensate for voltage drops in the output leads
- Linking of several devices for master-slave operation
- Vary internal output resistance
- Control of a selected device function via the floating trigger input

Terminal	Allocation	Meaning
Bottom Row of Terminals	1 TRG 1 +	Trigger input 1, plus
	2 TRG 1 -	Trigger input 1, minus
	3 TRG 2 +	Trigger input 2, plus
	4 TRG 2 -	Trigger input 2, minus
	5 SIG 1 +	Signal output 1, collector
	6 SIG 1 -	Signal output 1, emitter
	7 SIG 2 +	Signal output 2, collector
	8 SIG 2 -	Signal output 2, emitter
	9 SIG 3 +	Signal output 3, collector
	10 AGND 2	Auxiliary power AGND via fusing resistor 2
Top Row of Terminals	12 +15 V	Auxiliary power, +15 V
	12 AGND 1	Auxiliary power AGND via fusing resistor 1
	14 Uext +	External control voltage for analog voltage setpoint (plus); $U(U_{ext+}); U_{ana} = +k_u \times U(U_{ext+})$
	15 Uext -	External control voltage for analog voltage setpoint (minus); $U(U_{ext-}); U_{ana} = -k_u \times U(U_{ext-})$
	15 Iext +	External control voltage for analog current setpoint (plus); $U(I_{ext+}); I_{ana} = +k_i \times U(I_{ext+})$
	16 Iext -	External control voltage for analog current setpoint (minus); $U(I_{ext-}); I_{ana} = -k_i \times U(I_{ext-})$
	17 U MON	Voltage monitor with reference to AGND 1
	18 I MON	Current monitor with reference to AGND 1
	19 SENSE +	Sensing input, plus
	20 SENSE -	Sensing input, minus

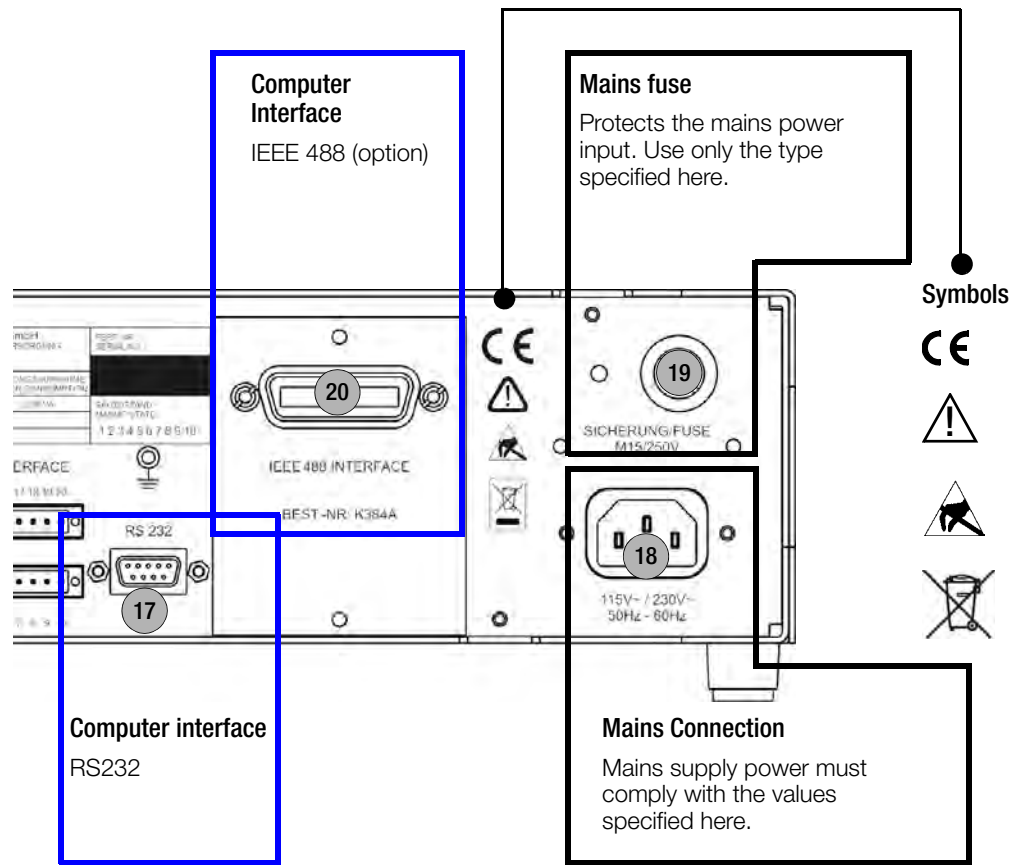

Symbols



Indicates EC conformity



Warning concerning a point of danger (attention: observe documentation!)



Observe ESDS directives



The device may not be disposed of with the trash. Further information regarding the WEEE mark can be accessed on the Internet at www.gossenmetrawatt.com by entering the search term WEEE.

Control Mode Status Display

CV LED lights up Constant voltage regulating mode: $U_{out} \approx U_{set}$

LED Plim / CP* lights up **yellow:** $P_{out} > P_{nom}$ (OL) **green*:** $P_{set} < P_{nom}$ progr. (CP)

CC LED lights up Constant current regulating mode: $I_{out} \approx I_{set}$

Protective Functions and Status Displays

OTP/OVP LED lights up Overtemperature protection triggered or output voltage ≥ 80 V exceeded, \Rightarrow OUTPUT = off

OVP LED lights up Overvoltage detection triggered, dU_{SET} and dU_{dLY} parameter values exceeded (prerequisite: dU_P parameter = on) \Rightarrow OUTPUT = off

OCP LED lights up Overcurrent detection triggered, dI_{SET} and dI_{dLY} parameters exceeded (prerequisite: dI_P parameter = on) \Rightarrow OUTPUT = off

OVP ON LED lights up Overvoltage shutdown is activated (dU_P parameter in device setup menu = on)

OCP ON LED lights up Overcurrent shutdown is activated (dI_P parameter in device setup menu = on)

Display A

Standard display: measured voltage value U_{out} , display function is changed by pressing the SELECT A key or by turning the rotary knob. Adjust resolution (select decimal place) with the \langle and \rangle scroll keys

Select A

Display selection:
 U_{out} \rightarrow **Uset** \rightarrow **OVset** \rightarrow **Pset**

Mains Switch

POWER LED lights up Device is switched on

POWER switch Switches the device on and off

Power Output On/Off Key

OUTPUT LED lights up Output is active

OUTPUT switch Switches the power output on and off

Rotary Encoder for Voltage

Voltage setpoint Uset – adjust output voltage Uset

Condition: UL_L (lower setting limit) $\leq U_{set} \leq UL_H$ (upper setting limit)

When the rotary encoder is activated the display is switched to Uset (LED) and the cursor becomes active – the selected decimal place blinks at the display and can be selected with the \langle and \rangle scroll keys. The new setpoint becomes effective immediately.

Uset adjusting alternatives	Activate by turning the rotary encoder, or select with Select A Uset	
Scroll keys	\langle \rangle : select decimal place	Δ ∇ : immediately increase or reduce Uset
Numeric keypad	Entry of numeric values, Uset LED blinks	Execute with \downarrow , or abort with ESC

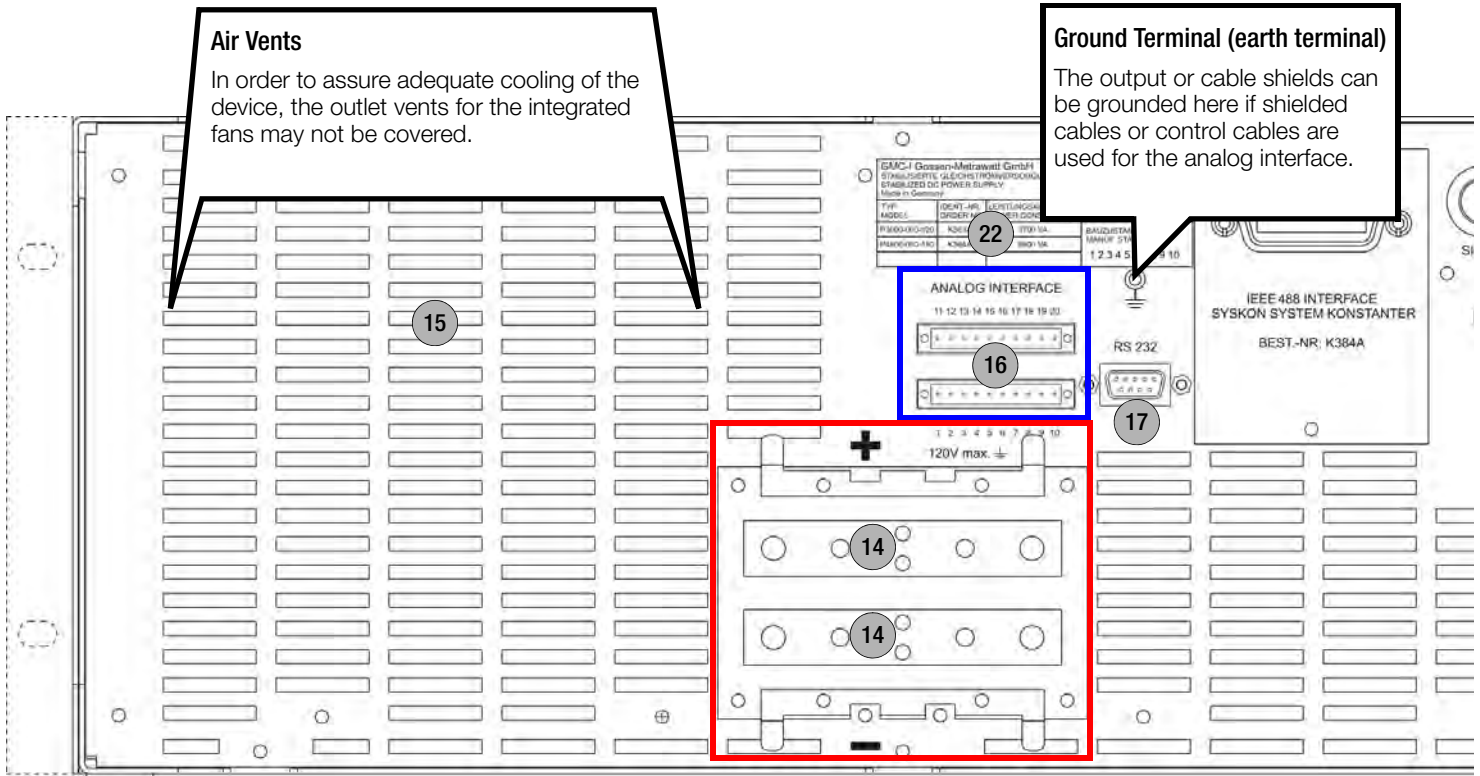

Power Output (14)

Terminals for connecting the power consumer. This is a floating output and can be grounded with the positive or the negative pole.

Output connections may only be connected and disconnected when the output is inactive (OUTPUT OFF)! Danger of arcing!

Connecting the Power Consumer

The output leads are connected to the terminal blocks by means of ring-type cable lugs with the included M6 x 10 screws. Measurement cables can be additionally connected to the 4 mm holes.

- Remove the safety cap.
- Connect the output leads to the terminal blocks with the provided screws and washers.
- An adequate wire cross-section and correct polarity must be assured. It is advisable to twist the output leads and to identify polarity at both ends.
- Avoid exerting excessive force at the terminals.
- Align the leads to the openings in the safety cap.
- Snap the safety cap back into place.

In order to prevent danger during use, shock-proof connector cables must be used when connecting power consumers.

Analog Interface (X13) (16)

- Remote control for output voltage and current
- External measurement of output voltage and current
- Connection of sensing leads in order to compensate for voltage drops in the output leads
- Linking of several devices for master-slave operation
- Vary internal output resistance
- Control of a selected device function via the floating trigger input

Terminal	Allocation	Meaning
Bottom Row of Terminals	1 TRG 1 +	Trigger input 1, plus
	2 TRG 1 -	Trigger input 1, minus
	3 TRG 2 +	Trigger input 2, plus
	4 TRG 2 -	Trigger input 2, minus
	5 SIG 1 +	Signal output 1, collector
	6 SIG 1 -	Signal output 1, emitter
	7 SIG 2 +	Signal output 2, collector
	8 SIG 2 -	Signal output 2, emitter
	9 SIG 3 +	Signal output 3, collector
	10 AGND 2	Auxiliary power AGND via fusing resistor 2
Top Row of Terminals	12 +15 V	Auxiliary power, +15 V
	12 AGND 1	Auxiliary power AGND via fusing resistor 1
	14 Uext +	External control voltage for analog voltage setpoint (plus); $U(U_{ext+}); U_{ana} = +k_u \times U(U_{ext+})$
	15 Uext -	External control voltage for analog voltage setpoint (minus); $U(U_{ext-}); U_{ana} = -k_u \times U(U_{ext-})$
	15 Iext +	External control voltage for analog current setpoint (plus); $U(I_{ext+}); I_{ana} = +k_i \times U(I_{ext+})$
	16 Iext -	External control voltage for analog current setpoint (minus); $U(I_{ext-}); I_{ana} = -k_i \times U(I_{ext-})$
	17 U MON	Voltage monitor with reference to AGND 1
	18 I MON	Current monitor with reference to AGND 1
	19 SENSE +	Sensing input, plus
	20 SENSE -	Sensing input, minus

Computer Interface

IEEE 488 (option)

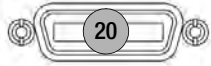

IEEE 488 INTERFACE
SYSKON SYSTEM KONSTANTER
BEST-NR: K384A

Computer Interface

RS232

Mains fuse

Protects the mains power input. Use only the type specified here.

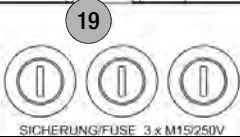

Mains Connection

Mains supply power must comply with the values specified here.

Symbols



Indicates EC conformity

Warning concerning a point of danger
(attention: observe documentation)

Observe ESDS directives

The device may not be disposed of with the trash. Further information regarding the WEEE mark can be accessed on the Internet at www.gossenmetrawatt.com by entering the search term WEEE.

6 Menu Structure and Parameters

MENU	Main menu level		Submenu level		Parameters level		Parameters level	
	Display A	Display B	Display A	Display B	Display A	Display B	Display A	Display B
<input type="checkbox"/>	SEtUP	dEUi c	dEUi c	Li Ni t	UL_L	00.00	UL_H A	60.000
	SETUP DEVICE		Limit value parameter		Voltage setting limit value, L = lower, U = upper			
	Setup menu		dEUi c	dUP	dUP B	on	dULdY	00.00
			Overvoltage menu		Overvoltage protection on/off			
			dEUi c	dCP	dCP	off	dCdLY	00.00
			Overcurrent menu		Overcurrent protection on/off			
			dEUi c	CFG_d	Pon	rSt	SSEt	7 off
					Device settings after power on			
	SEtUP	dPY iF	dPY iF	dPY	dPY-A	Uo	dPY-b	Io
	SETUP DISPLAY & INTERFACE		Digital display settings		Display A – standard display: Uo			
	Display and interface menu		dPY iF	AN iF	trG-1	off	trG-2	off
			Analog interface settings		Trigger input 1 on/off			
			dPY iF	bUS	Addr	i2	bAUd	9600
			Interface settings		Device address ⁶⁾ (IEEE488)			
	SEtUP	SE9	SE9	ctrL	SE9 6	Go	SE9	Hold
	SETUP SEQUENCE		Access sequence		Start sequence (RUN), footnote 3			
	Sequence menu		SE9	Cond, i	SE9-n 5	0	Strt	0097
			Sequence settings		Sequence no. (subsequence) footnote 1			
			SE9	Ed, t	NEt-A 4	0 100	USEt	39.000
			Edit sequence		Voltage setpoint			
			SE9	NEt	LoAd 2	0 105	StorE	0 105
			Memory functions		Load sequence value			
	SEtUP	NEAS	NEAS	nn-U 1	nn-U 1	off	U_	9.992
	SETUP MEASUREMENT		EXTREME MEASUREMENT		Min-Max memory			
	Measuring menu		NEAS	U I-CS	NEAS	U I-CS	Uc_	0.000
			NEAS	CFG_n	n-UP	3	n-tAb	
			NEAS	SPEc	rWPd footnote 5	30.53 1		
	AUE		Info		L-Err	000	E-rA	3
	AUXILIARY		Events and status memory		Last error no.			
	Memory and calibration menu		UErS 1		r-EL	0 1.00 1	UPd	no
			Firmware revision		Firmware version			
			AdJUS	7.10.11	UoFF	#	UFS	#
			Balancing routine	Balancing date	Voltage setpoint zero point			
					Voltage setpoint upper limit			

A Set parameter (example: upper limit value for voltage setpoint)

UL_H	60000	<input type="checkbox"/>	Acknowledge selection.
UL_H	60000	<input type="leftarrow"/>	Select entry position (decimal place). Number blinks, NUM LED key lights up.
UL_H	40000	<input type="up"/>	Increase/decrease value – alternative: Enter value directly with the numeric keypad.
UL_H	40000	<input type="checkbox"/>	Acknowledge parameter or abort procedure with ESC .
		ESC	Jump back to higher menu level.

B Select parameter – switch function on/off.

dUP	off	<input type="checkbox"/>	Acknowledge selection.
dUP	on	<input type="up"/>	Select status (here: off, on, r01 ... r12/r15*).
dUP	on	<input type="checkbox"/>	Acknowledge parameter.

Key

SEtUP	SE9	LED display (display A / B)
SEtUP	SE9	Parameter not yet set
#		Setting value is displayed, after which the measured value is entered and acknowledged with <input type="checkbox"/> .
<input type="leftarrow"/>	<input type="rightarrow"/>	Scroll within the parameters level. Select parameters.
<input type="checkbox"/>		Select submenu or parameters level.
ESC		Jump back to higher menu level.
6		Hot key for direct parameter selection

* /r15 as from firmware version 004

Parameters level		Parameters level		Parameters level		Parameters level		Parameters level		Parameters level		
Display A	Display B	Display A	Display B	Display A	Display B	Display A	Display B	Display A	Display B	Display A	Display B	
IL_L	00.00	IL_H	60.000									
Current setting limit value, L = lower, U = upper												
dUSEt	40.000											
Overvoltage protection trigger value												
dCSEt	80.000											
Overcurrent protection trigger value												
S_rh	oFF	E-dYh	r	SAUE	8 0 1	rcl	9 0 1	t 16	14 20	2006	08 04	
						Footnote 4		Footnote 5		Time (hhmm)	Year (YYYY)	M/D (mddd)
ddc	15											
Display delay time												
S_G-1	oFF	S_G-2	oFF	S_G-3	oFF	A_I_U	oFF	A_I_1	oFF			
Signal input 1 on/off		Signal input 2 on/off		Signal input 3 on/off		Voltage input on/off		Current input on/off				
db	8	Pb	nonE	Sb	1	USb	1 15.2t					
Number of data bits (RS232)		Parity bit (RS232)		Stop bit (1 or 2) (RS232)		Transmission speed (USB COM-Port)						
	Footnote 2					Footnote 2						
SE9	cont	SE9	StoP	SE9	Strt	SE9	StEP	SE9	bStP	SE9	ESc	
Resume sequence		Stop sequence		Jump to start address		Forward step-by-step		Backwards step-by-step		Exit sequence		
StoP	0 123	rEP	cont	tdEF	1.000							
Stop address		Repeat sequence		Default time								
ISEt	10.000	tSEt	tdEF	FSEt	rF							
Current setpoint		Dwell time	Default time	Function								
SE9_c	0 105	SE9_c	St-SP	SE9_r	0 10 1	SE9_1	0 108					
Delete memory location 105.		Delete start-stop mem. loc.		Delete & shift mem. loc.		Paste & shift mem. loc.						
U-	9.998	l_	0.204	l-	0.2 12							
Max. measured voltage value		Min. measured current value		Max. measured current value								
Uc-	60.000	lc_	0.000	lc-	60.000							
n-rFG		EN_U		EN_1								
ErB	0	ErC	0	CrA	1	crb	0					
Events memory B		Events memory C		Status memory A		Status memory B						
ldFF	#	lFS	#									
Current setpoint zero point		Current setpoint upper limit										

Additional key functions:
With sequence status RUN (after GO or CONT)

[ENTER] HOLD
 [ESC] Abort at actual address
 [0] Abort and jump to final value

With sequence status STOP (after Strt, Hold, StEP or bStP)

[UP] StEP
 [DOWN] BACKStEP
 [ENTER] CONT
 [ESC] Abort at actual address
 [0] Abort and jump to final value

See sequence status diagram chapter 10.3
*) The sequence is also aborted at the actual address, when turning an increment knob or pressing a select button. (sequence-status READY)

- Allows for viewing and processing of the following "condi (condition) parameters" in setup memory n specified by "Seq-n" (application: subsequences)
- Entry of numeric value n# is additionally possible, start address ≤ n ≤ stop address, → resume sequence at memory location n#
- Other display options can be selected while a sequence is being executed with the < and > keys:
The display does not return automatically to the standard display setting with this option, but rather when the sequence function has been completed or aborted.

	< Selected standard display setting	
nen-A	0005	Current memory location address
rrEP	cont	Remaining number of repetitions
SE9-n	00	Run is part of the main sequence
FSEt	_rU	Sequence function parameter
tSEt	tdEF	Memory location-specific dwell time
USEt ●	ISEt ●	For example calculated intermediate values for a ramp function
Uout ●	IOUt ●	Momentary measured values

- The < and > keys can be used as follows for scrolling while a selected RCL function is being executed (displays A and B blink until the selection is acknowledged with the ENTER key, or until the function is otherwise aborted).

rcl	02	Access setup register 02
autP	on	
USEt	12.000	
ISEt	25.000	
PSEt	1500.0	
aP	on	
dUSEt	80.00	
dCP	oFF	
dCSEt	80.00	
Pon	rSt	
trG-1	oFF	
trG-2	oFF	
A_I_U	oFF	
l	oFF	
Strt	000 1	
StoP	0005	

- Display function does not change automatically back to standard display
- the modification of a device address is not accepted until restarting the KONSTANTER.

7 Analog Interface

7.1 Connector pin assignments

Interface Type	Circuit Diagram	Function	Terminal	Meaning
TRG		TRG 1 +	1	Trigger Inputs <ul style="list-style-type: none"> Floating digital control inputs for controlling a device function defined by SETUP/dPYIF/AnI/trG 1 txt and SETUP/dPYIF/AnI/trG 2 txt Low signal: $-18 \text{ V} \leq U_s \leq +1 \text{ V}$ High signal: $+4 \text{ V} \leq U_s \leq +18 \text{ V}$ Current consumption: $I_s = (U_s - 2 \text{ V}) / 1.47 \text{ k}\Omega$
		TRG 1 -	2	
		TRG 2 +	3	
		TRG 2 -	4	
SIG		SIG 1 +	5	Signal Outputs <ul style="list-style-type: none"> Two floating digital status signal outputs One digital status signal output with reference to AGND (2) SIG 1±, SIG 2± and SIG 3+ indicate the statuses defined by SETUP/dPYIF/AnI/SiG 1 txt, SETUP/dPYIF/AnI/SiG 2 txt and SETUP/dPYIF/AnI/SiG 3 txt. Signal type: open collector Max. switching voltage: 30 V DC Max. switching current: 20 mA
		SIG 1 -	6	
		SIG 2 +	7	
		SIG 2 -	8	
		SIG 3 +,	9	
	AGND 2	10		

Interface Type	Circuit Diagram	Function	Terminal	Meaning
U _H		+15 V	11	+15 V (output) <ul style="list-style-type: none"> This auxiliary voltage output (15 to 18.5 V DC with reference to AGND 1 or AGND 2) can be used to control the trigger inputs, or to supply power to external components (e.g. reference element for generating control voltages). The output is equipped with electronic current limiting to approximately 60 mA, and is short-circuit proof to AGND 1 and AGND 2. AGND 1 and AGND 2 (analog ground = reference point) <ul style="list-style-type: none"> Reference point for the analog and digital control inputs and outputs These terminals are internally connected to the minus pole of the power output via a reversible fuse with a rating of 110 mA. The following is recommended: <ul style="list-style-type: none"> Use AGND 1 as a reference for the analog terminals on the upper terminal strip (pins 13 through 18). Use AGND 2 as a reference for the digital terminals on the bottom terminal strip (pins 1 through 9).
		AGND 1	12	
		AGND 2	10	

Interface Type	Circuit Diagram	Function	Terminal	Meaning
U_{set}		Uset + Uset -	13 14	<p>U_{ext} +, U_{ext} - (input)</p> <ul style="list-style-type: none"> Analog (differential) voltage input with reference to AGND for controlling the output voltage setpoint. The following applies with activated analog setpoint (SETUP/dPYIF/AnIF/AI_U on): <ul style="list-style-type: none"> $U_{set} = USET + k_u \times U(U_{ext} +) - k_u \times U(U_{ext} -)$ U_{set} = Resulting output voltage setpoint USET = Voltage setpoint, selected manually or digitally $U(U_{ext} +)$ = External control voltage (0 ... 5 V \triangleq 0 ... +Usetnom) with reference to AGND 1 $U(U_{ext} -)$ = External control voltage (0 ... 5 V \triangleq 0 ... -Usetnom) with reference to AGND 1 k_u = Control coefficient = Usetnom / 5 V Usetnom = 60 V (SYSKON P1500-060-060) Input impedance: a total of 10 kΩ each to AGND (1)
I_{set}		Iset + Iset -	15 16	<p>I_{ext} +, I_{ext} - (input)</p> <ul style="list-style-type: none"> Analog (differential) voltage input with reference to AGND for controlling the output current setpoint. The following applies with activated analog setpoint (SETUP/dPYIF/AnIF/AI_I on): <ul style="list-style-type: none"> $I_{set} = ISET + k_i \times U(I_{ext} +) - k_i \times U(I_{ext} -)$ I_{set} = Resulting output current setpoint ISET = Current setpoint which has been selected manually or digitally $U(I_{ext} +)$ = External control voltage (0 ... 5 V \triangleq 0 ... -Isetnom) with reference to AGND 1 $U(I_{ext} -)$ = External control voltage (0 ... 5 V \triangleq 0 ... -Isetnom) with reference to AGND 1 k_i = Control coefficient = Isetnom / 5 V Isetnom = 60 A (SYSKON P1500-060-060) Input impedance: a total of 10 kΩ each to AGND (1)
Monitor		U MON I MON	17 18	<p>U MON (output)</p> <ul style="list-style-type: none"> Analog voltage output with reference to AGND (1). Voltage is proportional to output voltage U_{out} detected by the sensing leads. 0 ... 10 V \triangleq 0 ... U_{outnom}. U_{outnom} = 60 V (SYSKON P1500-060-060) The output has an internal resistance of 8 kΩ and is short-circuit proof. <p>I MON (output)</p> <ul style="list-style-type: none"> Analog voltage output with reference to AGND (1). Voltage is proportional to internally measured output current I_{out}. 0 ... 10 V \triangleq 0 ... I_{outnom}. I_{outnom} = 60 A (SYSKON P1500-060-060). The output has an internal resistance of 8 kΩ and is short-circuit proof.
Sense		SENSE + SENSE -	19 20	<p>SENSE +, SENSE - (input)</p> <ul style="list-style-type: none"> For connection of sensing leads for 4-wire operation – allows for compensation of voltage drops (to 2 x 1 V) at long leads. Switching to 4-wire operation takes place automatically when the SENSE - lead is connected to the appropriate output pole or negative load pole.

7.2 Auto-sensing mode

Function

Output voltage values required for voltage measuring and control circuits can be acquired directly at the consumer instead of at the output terminals with the help of the SENSE + and SENSE – sensing lead terminals at the analog interface. Sensing mode operation (remote sensing) offers the following advantages:

- In the constant voltage regulating mode, current related voltage drops occurring in the output leads have practically no effect on voltage supplied to the consumer. Voltage at the output terminals is automatically increased to compensate for voltage drops.
- In the constant current regulating mode, voltage limiting at the consumer is independent of output current.
- Since the voltage value provided by the measuring function is relative to the voltage value acquired at the sensing leads, load parameters such as power consumption and load resistance can be more accurately determined.

The parameters and limit values included in figure 7.2, and in the chapter entitled “Electrical Data”, apply to operation with the sensing leads.

Connection

- The two sensing lead terminals at the analog interface (SENSE + and SENSE –) must be connected to their respective output poles at the desired point (generally speaking as close to the consumer as possible).
- It is advisable to twist and/or shield the sensing leads in order to minimize interference (connect shield to the ground terminal of the negative output pole).
- Long output and sensing lead impedances may result in control fluctuations at the output, especially with capacitive consumers. This effect can be counteracted by connecting capacitors (CS+, CS-) between the SENSE and output terminals (see figure 7.2). If the output leads are twisted, their impedance can be reduced as well.
- Incorrect connection of the sensing leads does not damage the KONSTANTER, although it results in the following reversible events:
 - Polarity reversal at sensing leads or interrupted output lead: If output voltage is not being limited at the KONSTANTER by means of current regulation, it climbs to well above the selected value which finally triggers overvoltage protection and immediately deactivates the output.
 - Interrupted SENSE + lead: Voltage between the output terminals increases by approximately 15%.
 - Interrupted SENSE – lead: The sensing terminals are deactivated (automatic return to local sensing).

If the sensing leads have been connected incorrectly, rising voltage between the output terminals is not acquired by the measuring function.

$$C_{s+}, C_{s-} = 10 \mu\text{F to } 220 \mu\text{F}$$

$$U_{s+}, U_{s-} \leq 1 \text{ V}$$

$$I_{s+} \approx U_{\text{outS}} / 180 \text{ k}\Omega$$

$$I_{s-} \approx 0.3 \text{ mA}$$

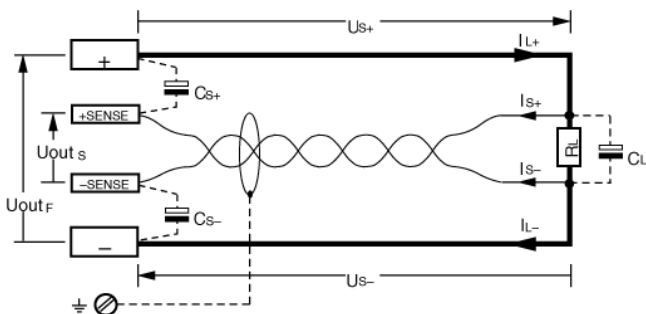

Figure 7.2 Connecting the Consumer for Sensing Mode Operation

Activation

- The remote sensing mode function is activated automatically after the SENSE – terminal has been connected to the corresponding output pole.
- The function is deactivated once again by interrupting this connection.

7.3 Status Signal Outputs

Function

- The KONSTANTER is equipped with three digital open collector outputs for indicating status.
 - Two floating outputs SIG 1 ±, SIG 2 ± and
 - One with reference to AGND: SIG 3 +
- The device status or event to be indicated is independent for all three signal outputs. Selection is made by setting the following functions:
 - SETUP/dPYIF/AnIF/SIG-1 txt,
 - SETUP/dPYIF/AnIF/SIG-2 txt and
 - SETUP/dPYIF/AnIF/SIG-3 txt (see chapter 6, “Menu Structure” and chapter 7, “Operating Commands”).
- As a status signal for monitoring devices
- For controlling external output relays

Application

- Triggering of certain device functions can be synchronized by means of connection to the trigger inputs of other KONSTANTERS.

Connection

- Values for connection –
 - Max. switching voltage: 30 V DC
 - Max. switching current: 20 A
- If you want to use the signal outputs to send status signals to external monitoring devices, pull-up resistors must be used in order to achieve appropriate levels. The status signal outputs can be connected to the + 15 V terminal with pull-up resistors (at least 1 kΩ), in order to generate an active high signal of + 15 V.

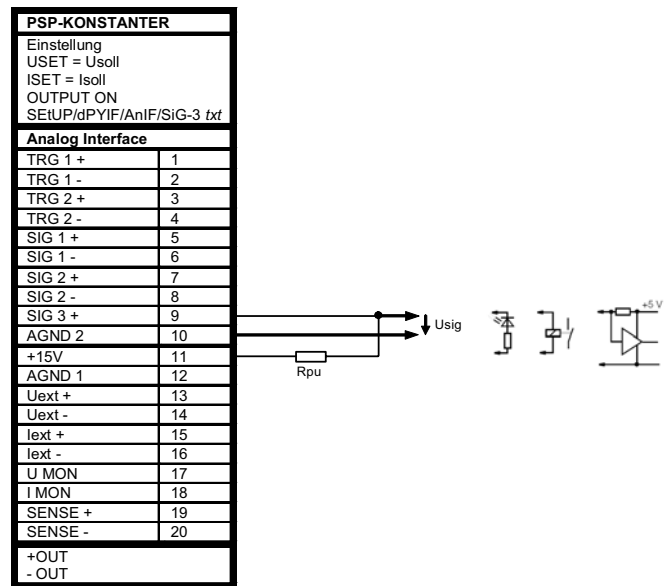

Figure 7.3 Wiring Examples for Status Signal Outputs

Setting Parameters for Status Signal Outputs

txt	Meaning – Allocation	Level
OFF	SIG n: direct off	passive high
ON	SIG n: direct on	active low
OUT	OUTPUT ON	passive high
	OUTPUT OFF	active low
MODE	OFF or CV	passive high
	CC or OL	active low
SEQ	READY/STOP	passive high
	RUN	active low
SSET	OFF	passive high
	ON	active low
U_LO ¹	U _{meas} ≥ w1	passive high
	U _{meas} < w1	active low
U_HI ¹	U _{meas} ≤ w2	passive high
	U _{meas} > w2	active low
I_LO ¹	I _{meas} ≥ w3	passive high
	I _{meas} < w3	active low
I_HI ¹	I _{meas} ≤ w4	passive high
	I _{meas} > w4	active low

1 The signal outputs can be logically linked using the comparison function. The comparative values are defined by parameters w1, w2, w3 and w4 from the UI_C_ - SET command. Momentary measured voltage and current values are compared with these parameters and evaluated.

7.4 Regulating Output Voltage

Function

Output voltage U_{out} can be set by means of external control voltage U_{su} = U(U_{ext} +) – U(U_{ext} –) via control inputs U_{ext} + (non-inverting) and U_{ext} – (inverting).

- The voltage control input functions as a differential voltage input:
- The following applies with activated analog setpoint (SETUP/dPYIF/AnIF/AI_U on):

$$U_{set} = USET + k_u \times U(U_{ext} +) - k_u \times U(U_{ext} -)$$

U_{set} = Resulting output voltage setpoint

USET = Voltage setpoint which has been selected manually or digitally

U(U_{ext} +) = External control voltage (0 ... 5 V ≥ 0 ... +U_{setnom}) with reference to AGND (1)

U(U_{ext} –) = External control voltage (0 ... 5 V ≥ 0 ... –U_{setnom}) with reference to AGND (1)

k_u = Control coefficient = U_{setnom} / 5 V

U_{setnom} = 60 V (SYSKON P1500-060-060)

- Max. adjusting error:
SYSKON P1500: ±0.2% U_{nom} ±0.6% setting value
SYSKON P3000: ±0.25% U_{nom} ±0.6% setting value
SYSKON P4500: ±0.25% U_{nom} ±0.6% setting value.
- Input resistance: 10 kΩ each

Notes

- The control inputs are not floating inputs: Their reference point, AGND (1), is connected to the negative pole of the power output.
- Connecting grounded circuits to the control input may result in erroneous settings due to leakage current or ground loops.
- If the reference point of control voltage U_{su} is connected to the negative output pole at the load side, the inverting input must be connected to this point (connection b in figure 7.4). Influences resulting from voltage drops in the output lead are thus avoided.
- If control voltage is isolated from the output, connect U_{ext} – to AGND (1) (connection a in figure 7.4).
- If remote adjustment of output voltage is to be accomplished by means of a potentiometer, wiring can be laid out as shown in figure 7.4.

- U_{su} can also be applied as an alternating voltage, for example in order to superimpose manually selected direct voltage USET with interference signals. The maximum operating frequency of modulated output voltage depends upon voltage amplitude, the setting selected for current limiting and load, and thus cannot be defined with a simple formula. It is increased as amplitude is decreased, and as current limiting and load are increased.

Connection

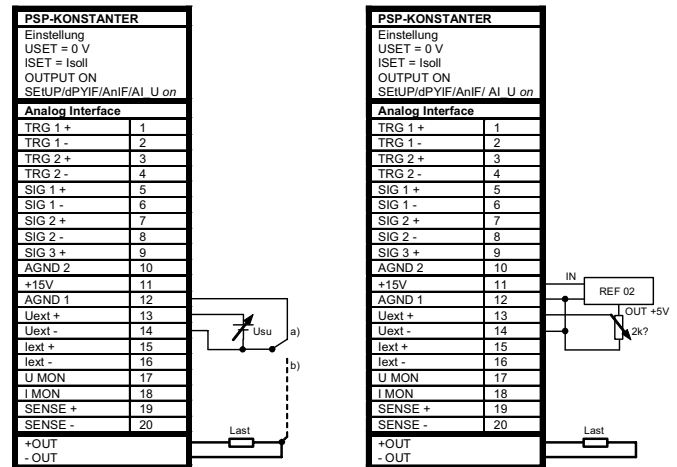

Figure 7.4 Wiring for Controlling Output Voltage with External Voltage / External Potentiometer

7.5 Controlling Output Current

Function

Output current I_{out} can be set with external voltage U_{si} = U(I_{ext} +) – U(I_{ext} –) via control inputs I_{ext} + (non-inverting) and I_{ext} – (inverting).

- The current control input functions as a differential voltage input:
- The following applies with activated analog setpoint (SETUP/dPYIF/AnIF/AI_I on):

$$I_{set} = ISET + k_i \times U(I_{ext} +) - k_i \times U(I_{ext} -)$$

I_{set} = Resulting output current setpoint

ISET = Current setpoint which has been selected manually or digitally

U(I_{ext} +) = External control voltage (0 ... 5 V ≥ 0 ... +I_{setnom}) with reference to AGND (1)

U(I_{ext} –) = External control voltage (0 ... 5 V ≥ 0 ... –I_{setnom}) with reference to AGND (1)

k_i = Control coefficient = I_{setnom} / 5 V

I_{setnom} = 60 A (SYSKON P1500-060-060)

- Max. adjusting error:
SYSKON P1500: ±0.2% I_{nom} ±1.2% setting value
SYSKON P3000: ±0.15% I_{nom} ±1.2% setting value
SYSKON P4500: ±0.133% I_{nom} ±1.2% setting value
- Input resistance: 10 kΩ each

Notes

- The control inputs are not floating inputs: Their reference point, AGND (1), is connected to the negative pole of the power output.
- Connecting grounded circuits to the control input may result in erroneous settings due to leakage current or ground loops.
- If the reference point of control voltage U_{si} is connected to the negative output pole at the load side, the inverting input must be connected to this point (connection b in figure 7.5). Influences resulting from voltage drops in the output lead are thus avoided.
- If control voltage is isolated from the output, connect I_{ext} – to AGND (1) (connection a in figure 7.5).

- If remote adjustment of output current is to be accomplished by means of a potentiometer, wiring can be laid out as shown in figure 7.5.
- Usi can also be applied as an alternating voltage, for example in order to superimpose manually selected direct current ISET with interference signals. To a great extent, the maximum operating frequency of modulated output current depends upon the output current value, as well as the voltage amplitude which results from the prevailing load, and thus cannot be defined with a simple formula. It is increased as amplitude is decreased, and as load is increased.

Connection

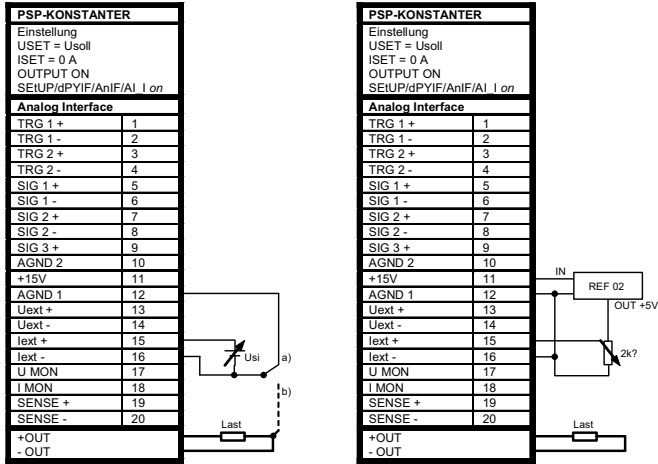
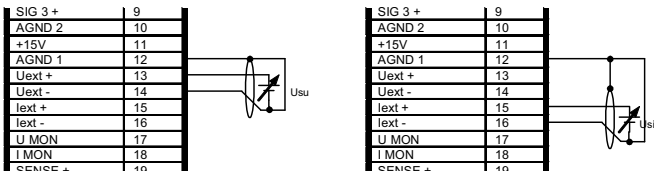

Figure 7.5 Wiring for Controlling Output Current with External Voltage / External Potentiometer



Attention!

Control inputs Uext +, Uext – and Iext +, Iext – should only be connected with shielded cable. Connect the shield to the AGND (1) reference point.



7.6 Voltage Monitoring Output

Function

- The U MON terminal reads out voltage Umu with reference to AGND (1), which is proportional to output voltage Uout.
- U MON serves as a control voltage for master-slave series connection.
- However, U MON can also be used for external measuring, monitoring and recording.
- The following applies:
 $U_{mu} = U_{out} \times k_{mu} \times k_{load}$ ($k_{load} = 1: 0 \dots 10 \text{ V} \triangleq 0 \dots U_{outnom}$)
 $k_{mu} = 10 \text{ V} / U_{outnom}$; U-monitor coefficient
 $k_{load} = R_{load} / (R_{load} + R_i)$; load coefficient
 $R_i(\text{U MON}) = 8 \text{ k}\Omega$; U-monitor internal resistance
 $R_{load} = \text{Load resistance (internal resistance of the measuring instrument)}$
 $U_{outnom} = 60 \text{ V (SYSKON P1500-060-060)}$
- Max. error for Umu/kmu (where $R_{load} > 10 \text{ M}\Omega$):
 SYSKON P1500: $\pm 0.2\% U_{nom} \pm 0.4\%$ actual value
 SYSKON P3000: $\pm 0.3\% U_{nom} \pm 0.6\%$ actual value
 SYSKON P4500: $\pm 0.3\% U_{nom} \pm 0.8\%$ actual value

Notes

- U MON is not a floating output: Its reference point, AGND (1), is connected to the negative output pole.
- Connecting grounded measuring circuits to the monitor output may result in erroneous measurements due to leakage current or ground loops.
- The voltage monitoring output makes reference to output voltage acquired at the sensing leads.
- The monitor output is short-circuit proof. Internal resistance is $8 \text{ k}\Omega$.

Connection

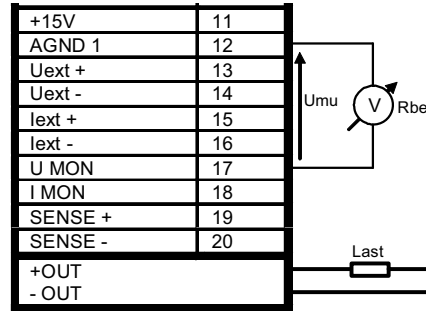

Figure 7.6 Voltage Monitor Wiring

7.7 Current Monitoring Output

Function

- The I MON terminal reads out voltage Umi with reference to AGND (1), which is proportional to output current Iout.
- I MON serves as a control voltage for master-slave parallel connection.
- However, I MON can also be used for external measuring, monitoring and recording.
- The following applies:
 $U_{mi} = I_{out} \times k_{mi} \times k_{load}$ ($k_{load} = 1: 0 \dots 10 \text{ V} \triangleq 0 \dots I_{outnom}$)
 $k_{mi} = 10 \text{ V} / I_{outnom}$; I-monitor coefficient
 $k_{load} = R_{load} / (R_{load} + R_i)$; load coefficient
 $R_i(\text{I MON}) = 8 \text{ k}\Omega$; I-monitor internal resistance
 $R_{load} = \text{Load resistance (internal resistance of the measuring instrument)}$
 $I_{outnom} = 60 \text{ A (SYSKON P1500-060-060)}$
- Max. error for Umi/kmi (where $R_{load} > 10 \text{ M}\Omega$):
 SYSKON P1500: $\pm 0.3\% I_{nom} \pm 1.2\%$ actual value
 SYSKON P3000: $\pm 0.2\% I_{nom} \pm 1.2\%$ actual value
 SYSKON P4500: $\pm 0.167\% I_{nom} \pm 1.2\%$ actual value

Notes

- I MON is not a floating output: Its reference point, AGND (1), is connected to the negative output pole.
- Connecting grounded measuring circuits to the monitor output may result in erroneous measurements due to leakage current or ground loops.
- The monitor output is short-circuit proof. Internal resistance is $8 \text{ k}\Omega$.

Connection

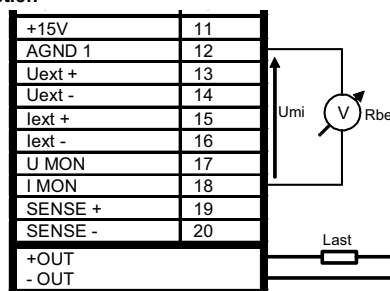

Figure 7.7 Current Monitor Wiring

7.8 Trigger Inputs

Function

- Floating optocoupler inputs TRG 1± and TRG 2± allow for remote control of a device function with the help of a binary signal.
- The function to be controlled is selected by manually or digitally configuring the trigger mode (SETUP/dPYIF/AnIF/trG 1 txt or SETUP/dPYIF/AnIF/trG 2 txt).

Connection

- Connect the control signal between TRG 1(2) + and TRG 1(2) -.

Signal level:

Low signal: $-18\text{ V} \leq U_s \leq +1\text{ V}$

High signal: $+4\text{ V} \leq U_s \leq +18\text{ V}$

Current consumption: $I_s = (U_s - 2\text{ V}) / 1.47\text{ k}\Omega$

- The TRIGGER input can be driven with the +15 V output at the analog interface via any desired switch (figure 7.8).



Warning!

Trigger inputs TRG 1± and TRG 2± are floating inputs and are functionally isolated from the output current circuit. This functional isolation is not equivalent to "safety separation" as specified in electrical safety regulations.

Note

The trigger inputs are sampled by the digital control unit approximately every 10 ms. After a signal change has been detected, repeated querying ensues at short time intervals (suppression of switch bouncing and interference pulses). This means that:

- Trigger signal pulses must have a minimum duration of 14 ms in order to assure reliable recognition.
- A delay of 1 to 15 ms may occur between application of the control signal and triggering of the controlled function.

Connection

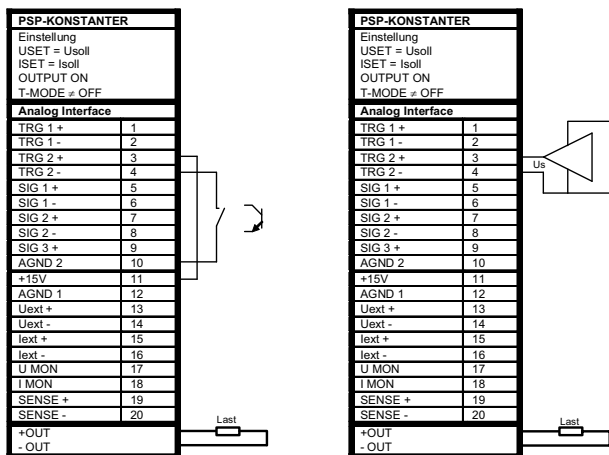

Figure 7.8 Controlling the Trigger Input with a Switching Element / External Signal

Trigger Function Setting Parameters

Parameters		Meaning
OFF		Trigger input function is deactivated, trigger signals have no effect.
OUT	OUTPUT	Trigger signal acts upon the OUTPUT: output on/off.
	Low	OUTPUT depends upon manual setting or programming command.
	Edge Low → High	OUTPUT remains OFF or OUTPUT is switched OFF.
	High	OUTPUT is OFF and cannot be activated (neither manually nor by means of a program command).
	Edge High → Low	The OUTPUT is activated; exception: OTP or OVP.
SQS	Step function	Memory recall (step-by-step sequence control)
	Edge Low → High	Start trigger signal
	High	<ul style="list-style-type: none"> The trigger signal is a high pulse with a duration of less than 800 ms. A high pulse with a duration > 1.0 s resets the address counter to the start address at any point in time, and execution begins with the next trigger signal.
	Edge High → Low	The high → low edge of the (short) trigger signal results in step-by-step control of the currently selected sequence, regardless of the specified time and number of repetitions. Recall of the memory's contents begins with the START address. Each trigger signal increases the address by 1, until the STOP address is reached. The next pulse once again causes execution of the contents of the START address.
SEQ	SEQUENCE	Sequence execution control
	Edge Low → High	The SEQUENCE function is started beginning with the start address (SEQUENCE GO).
	Edge High → Low	Ends sequence execution by jumping to the stop address
LLO	LOCAL LOCKED	Front panel control disabling
	Low	All front panel controls are functional.
	High	All front panel controls are disabled except for the mains switch, and activation is not possible with the LOCAL key.
MIN	MINMAX	Storage of Min-Max values for U and I is controlled when the MINMAX function is activated (MINMAX ON)(U_ ON).
	Low	The Min-Max function is active.
	Edge Low → High	The Min-Max function is deactivated. Values in the Min-Max memories remain unchanged.
	High	The Min-Max function is inactive.
	Edge High → Low	Values in the Min-Max memories are reset and replaced with momentary output values. The Min-Max function is activated.
AIX	Analog Input	Uext, Iext
	Low	Analog setpoints not switched through
	High	Analog setpoints switched through
AIU	Analog Input	Uext
	Low	Analog setpoint not switched through
	High	Analog setpoint switched through
All	Analog Input	Iext
	Low	Analog setpoint not switched through
	High	Analog setpoint switched through

7.9 Parallel Connection

If output current from a single KONSTANTER is insufficient for the respective application, the outputs of any number of KONSTANTERs can be parallel connected.



Attention!

If outputs with different nominal voltages are parallel connected, all outputs must be limited to the lowest utilized nominal voltage value. The ULIM parameter is used to select this setting.

7.9.1 Direct Parallel Connection

Function

- Easiest way to provide the consumer with more current than is available from a single r KONSTANTER.
- KONSTANTERs with differing nominal output voltages can be used. However, all voltage setpoints must be set or limited to the same value.
- This setup is less suitable for the constant voltage regulating mode.

Wiring

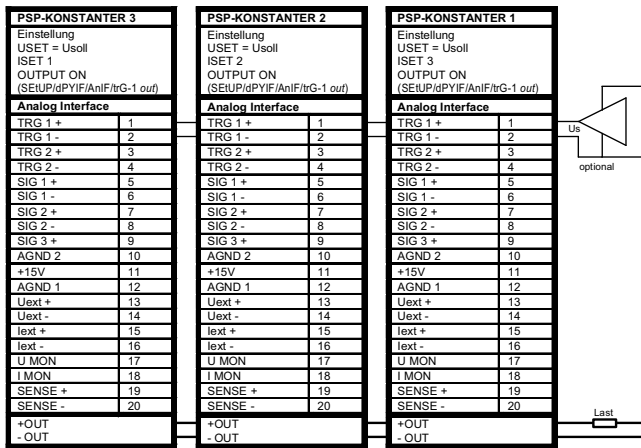

Figure 7.9.1a Wiring for Direct Parallel Connection

Settings

- Deactivate all outputs.
- Adjust voltage setpoint USET at all parallel connected KONSTANTER to approximately the same value:

$$U_{set} = USET1 = USET2 = USET3 = \dots = USETn$$
- Adjust current setpoints ISET such that they add up to the desired cumulative current value Iset:

$$I_{set} = ISET1 + ISET2 + ISET3 + \dots + ISETn$$
- Activate the outputs.

Functional Principle

- After switching the outputs on, load current is initially supplied by the KONSTANTER with the highest voltage setting.
- If load resistance is continuously reduced, load current is continuously increased.
- When load current reaches the ISET value selected for the output which is momentarily supplying power to the consumer, current limiting is activated at this output.
- If load resistance is further decreased, current regulation reduces output voltage until the voltage value of the output with the next lower setting is reached.
- As of this point in time, this KONSTANTER also supplies a portion of the load current.

- This procedure is continued until load current triggers current regulating at the output with the lowest voltage setting when the setpoint value for cumulative current is reached.
- This output maintains constant load current until the load resistor is short-circuited.

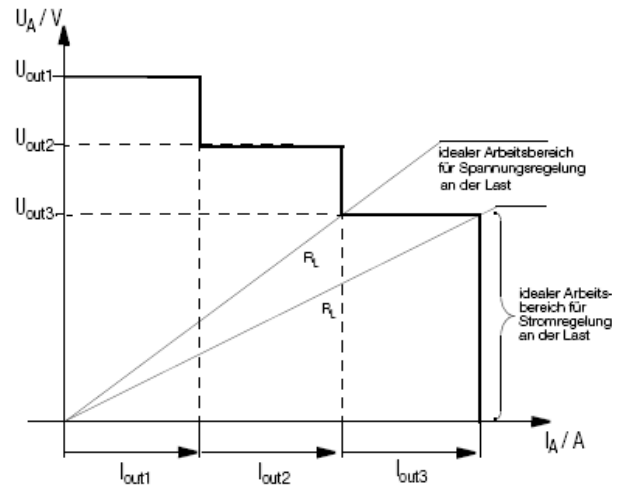

Figure 7.9.1b U / I Diagram for Direct Parallel Connection

Notes

- Slightly varying voltages occur at the individual outputs as a result of setting tolerances.
- In the event of larger voltage differences, an electronic sink is activated at the outputs with lower voltage settings.
- The sink controller attempts to reach the lower voltage value by limiting power consumption.
- Neither the KONSTANTERs nor the power consumer are damaged as a result.
- If problems occur with the measurement of load current, the KONSTANTERs should be linked by means of master-slave parallel connection.
- The outputs can be activated and deactivated commonly by connecting the trigger inputs in parallel (see figure 7.9.1a, optional connection) or series (setting: "SetUP/dPYIF/AnIF/trG-1 out").

7.9.2 Master-Slave Parallel Connection

Function

As opposed to direct parallel connection, master-slave parallel connection offers significant advantages:

- Equally suitable for voltage and current regulation
- Output parameters (output voltage, cumulative current limiting) are set entirely by the master device.
- All interconnected KONSTANTERs are equally loaded.

Wiring

- Define one power supply as a master device.
- Connect master and slave devices as shown in figure 7.9.2.
- Connect the output leads.
- Balance the individual output current values. Keep connector cables as short as possible, and use the largest possible conductor cross-section. Execute balancing with Rsym (set potentiometer to approx. 2 kΩ).

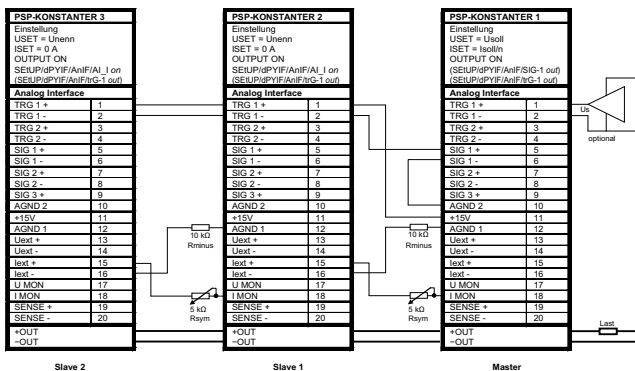

Figure 7.9.2 Wiring for Master-Slave Parallel Connection

Settings

Initial power-up:

- Short circuit the load.
 - Switch the master on (mains) and configure settings:
 - (Pon rcl) if desired
 - OUTPUT off
 - USET = Uset Desired output voltage
 - ISET = Iset / n
 - Iset: desired cumulative output current;
 - n: number of devices
 - Only valid if nominal data are identical for all devices, see notes.
 - Switch slave 1 on (mains) and configure:
 - (Pon rcl) if desired
 - USET > USET master
 - The voltage setpoint at the slave devices must be set at least 1% higher than at the master device, e.g. to maximum.
 - ISET = 0 A Deactivate the ISET rotary knob if applicable by setting ILIM to 0 A.
 - SETUP/dPYIF/AI_1 on
 - Activates the analog current setpoint
 - Use the same procedure for additional slave devices.
 - Press the OUTPUT ON key at the slave(s) and the master.
 - Check output current at the slave device displays.
 - Output current at each of the slaves can be precisely matched to master output current by adjusting Rsym.
 - Changes appear immediately at the respective display.
 - Undo short-circuiting of the load.
- From this point on, setting and regulation of (cumulative) output parameters are controlled entirely by the master device.

Power-up after initial settings:

Devices can be switched on and off in any desired order.

Functional Principle

The master controls output current of the downstream device (slave 1) via the slave's current control input with the help of the current monitoring signal.

Slave 1 functions as a master device for the next downstream slave (slave 2), and so forth.

Cumulative output current is thus always proportional to master output current.

Notes

KONSTANTERs with differing nominal values:

The KONSTANTER with the smallest nominal voltage value must always be used as the master device.

The voltage setting range of the other KONSTANTERs must be limited to this lowest value using the ULIM parameter.

General

- The current regulator's dynamics can be slowed down in order to achieve more stable performance. Select the following setting to this end "SETUP/dEVic/CFG d/C dYn L".
- Rsym can be implemented as a 2 kΩ fixed resistor; adjusting error for the slaves is increased somewhat as a result.
- A wire connection can be used instead of Rsym and Rminus can be omitted, if no precise setpoint value is required for cumulative output current. In this case, each slave device supplies slightly more current than the master device.
- If analog interface connector cables and the sensing leads are longer than 1 meter, shielded cable should be used. The shield is connected to the ground terminal on the housing or to - OUT.
- The master device's measuring function acquires commonly generated output voltage for all interconnected KONSTANTERs, but only acquires its own output current.
- The individual measured current values for each of the interconnected KONSTANTERs must be added together in order to arrive at cumulative output current.
- In order to assure that the slaves' OUTPUT ON status is activated along with the master's OUTPUT ON status via the signal output and trigger input circuit as shown in figure 7.9.2, "SETUP/dPYIF/AnIF/SiG-(x1) out" must be selected at the master and "SETUP/dPYIF/AnIF/trG-(x2) out" must be selected at the slaves, (x1) and (x2) in example 1. The master's OUTPUT ON status can be optionally controlled via the trigger input – setting at the master: "SETUP/dPYIF/AnIF/trG-(x3) out", (x3) in example 1.

7.10 Series Connection

If output voltage from a single KONSTANTER is insufficient, or if you want to generate a \pm voltage, the outputs of several KONSTANTERs can be connected in series.



Warning!

Maximum allowable cumulative voltage for series connection is 240 V (or 480 V with grounded neutral point).

7.10.1 Direct Series Connection



Attention!

If outputs with differing nominal values are series connected, the highest selected current value is present at all outputs in the event of short-circuit. However, the internal reverse-voltage protection diode is only rated for nominal current of the respective device (see reverse voltage withstand under "Electrical Data"). For this reason, all current setpoints must be set to the lowest nominal current value of all interconnected devices.

The ILIM parameter is used to select this setting.

Function

- The easiest way to supply the consumer with more voltage than is available from a single KONSTANTER
- Easy wiring
- Less suitable for constant current regulating mode.

Wiring

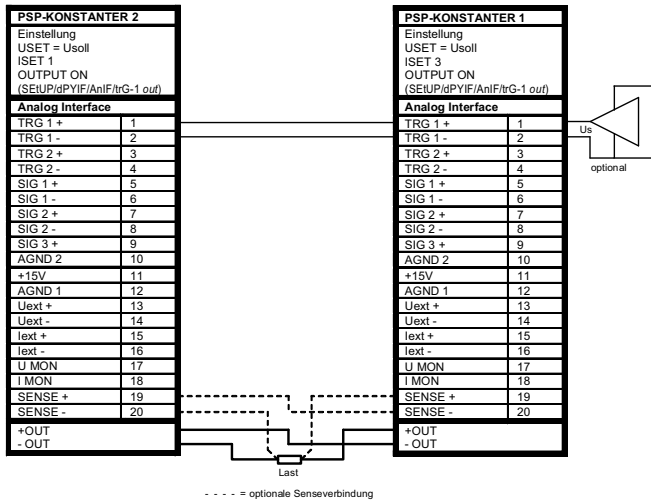

Figure 7.10.1a Wiring for Direct Series Connection

Settings

- Deactivate all outputs.
- Adjust current setpoint ISET at all series connected KONSTANTER to approximately the same value:
- $I_{set} = ISET1 = ISET2 = ISET3 = \dots = ISETn$
- Adjust voltage setpoints USET such that they add up to the desired cumulative voltage value U_{set} :
- $U_{set} = USET1 + USET2 + USET3 + \dots + USETn$
- Activate the outputs.

Functional Principle

The sum of all individual output voltages is made available to the power consumer.

If load resistance is continuously reduced, all of the outputs deliver the same load current at first.

When load current reaches the lowest selected current setpoint value, current regulating is triggered at the respective output.

If load resistance is further reduced, this output maintains constant load current until its output voltage has dropped to 0 V.

If even further reduction of load current occurs, the affected output is forced by the other outputs to generate a negative voltage. As of approximately -0.5 V, the internal reverse-voltage protection diode becomes conductive.

Load current can once again climb, until current regulation is activated at the output with the next higher current setpoint value.

This procedure is continued until load current triggers current regulating at the output with the highest current setpoint value.

Current is held constant by this last output until short-circuiting occurs.

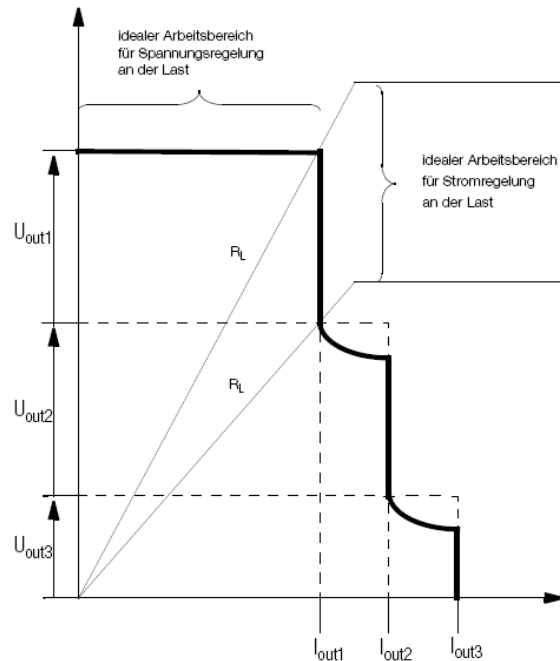

Figure 7.10.1b U / I Diagram for Direct Series Connection

Note

The outputs can be activated and deactivated commonly by connecting the trigger inputs in parallel (see figure 7.10.1a, optional connection) or series (setting: "SETUP/dPYIF/AnIF/trG 1 out").

7.11 Varying the Internal Output Resistance Value

Function

In the voltage regulating mode, internal output resistance has a value of close to 0Ω .

The internal output resistance value can be increased for certain applications, for example simulation of long output cables or weak automotive batteries. The selected (open-circuit) output voltage is reduced in proportion to increasing load (figure 7.11 a)

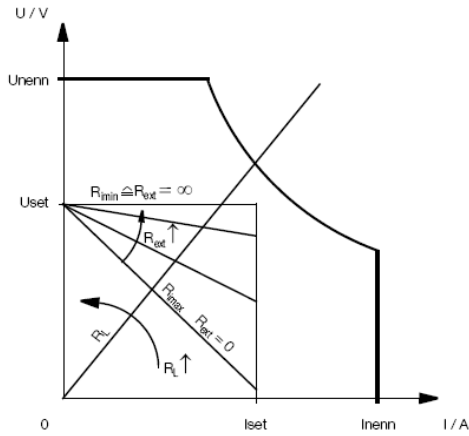

Figure 7.11a Output Voltage with Reference to Load

Calculation

The following applies:

$$R_i = \frac{20\text{kW}}{18\text{kW} + R_{\text{ext}}} \times \Omega \quad \text{where } \infty \geq R_{\text{ext}} \geq 0 \Omega$$

$$R_{\text{ext}} = \frac{20\text{kW}}{R_i} \times \text{W} - 18\text{k}\Omega \quad \text{where } 0 \Omega < R_i \leq 1.11 \Omega$$

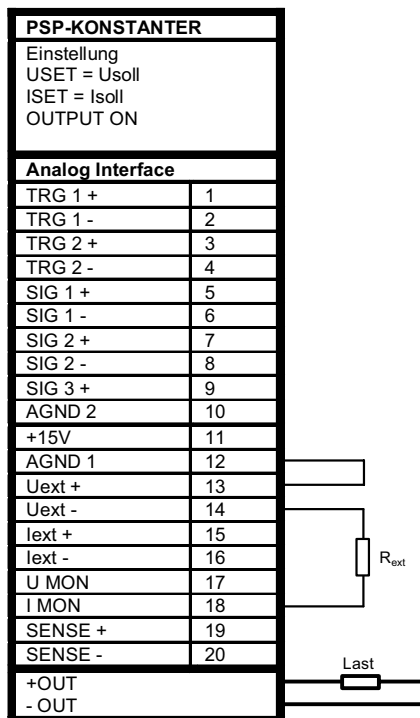

Figure 7.11b Wiring for Varying Internal Resistance

8 Descriptions of Operating Commands

All setting and query commands are described and listed alphabetically in the following pages.

Commands with an asterisk (*) are at the beginning of the list.

Each heading includes the command, along with its abbreviation. Insofar as query commands exist (identified with a question mark ?), they are listed as well.

The next line (with the hand symbol) indicates how the respective command can be executed manually. If keys are required, they are mentioned as well.

The note "Menu" indicates that the respective command can be executed from the menu.

If no manual procedure for executing the command exists, this is indicated with a long dash (—).

Details on Memory Locations

Depending on the firmware version, a different number of memory locations is available, see table below.

Firmware Version	Memory Locations
Version 003	12 SETUP memory locations 1536 SEQUENCE memory locations
Version 004	15 SETUP memory locations 1700 SEQUENCE memory locations

Function „General-RESET“ (manual operation only)

Function „General-RESET“ deletes the complete user memory: setup memory, sequence memory, interface settings.

The default values are set, see default settings of the respective setting commands.

The following data remain unchanged: Device balancing parameters, production/serial number as well as time and date setting.



Attention!

Before performing a „General-RESET“, we recommend that you note or save your setting parameters, e.g. via the STORE command.

To perform a „General-RESET“, press and hold the cursor keys < and > during „POWER ON“ until „rdy“ blinks in the display.

*CLS – Clear Status



Function

The *CLS command clears all event registers and the status byte register, except for the MAV bit (Message Available). Any existing service requests are cancelled.

Addressing status	Unchanged
Input and output buffers	Unchanged
Service request SRQ	Cleared
Status byte register STB	Cleared except for MAV bit
Event registers ESR, ERA, ERB, ERC	Cleared
Enable registers ESE, ERAE, ERBE, ERCE, SRE, PRE	Unchanged
Set or stored parameters	Unchanged

The *CLS setting command also clears the error number list (first 3 parameters) in the response to the "ERROR?" query command:

"ERROR 000,000,000,xxx"

Setting Command

Syntax: ***CLS**

*DDT, *DDT? – Define Device Trigger



Function

A list of commands including up to 80 characters can be entered to a register with the "define device trigger" command. The *DDT command list is executed after receiving the *TRG device message or the IEC bus command GET (GROUP EXECUTE TRIGGER). The content of the DDT register can be read out with the *DDT? query command. Maximum response string length: 80 characters.

Setting Command

Syntax: ***DDT** *command[/command[/command] ...*
|— max. 80 characters —|

Default setting

or after RESET (*RST): DDT memory cleared

Note: A slash (/) must be used as the delineating character between commands in the DDT string instead of a semicolon (;). All specified device messages (setting and query commands) are allowable as parameters except for the *TRG command.

Query Command

Syntax: ***DDT?**

Sample response string: **USET 10;ISET 5.6;OUT ON**

Note: The delineating slashes (/) appear once again as semicolons (;) in the response string.

Comments

In order to prevent the generation of query errors, a blank (space) is returned if the DDT register is empty.

If the maximum DDT string length is exceeded, all characters in excess of the allowable number are ignored and an execution error message is generated.

The received command list is not checked for correct syntax and limit values until the trigger command is received.

If an execution error occurs, the DDT register can be read out with the *DDT? command, but its content cannot be executed (execution error message is generated again).

The DDT register is not changed or cleared when the trigger command is executed.

***ESE, *ESE?, *PRE, *PRE?, *SRE, *SRE?, ERAE, ERAE?, ERBE, ERBE?, ERCE, ERCE? – Enable registers**



Function

The enable registers determine which bit(s) from the corresponding event or status byte register is/are capable of influencing the respective group message. The respective group message remains set (1 = TRUE), as long as at least one bit which has been enabled to this end has a status of TRUE.

This allows for selective enabling or disabling of an SRQ and/or the individual status message "IST" due to an occurred event (masking).

The device is equipped with six enable registers. They can be written to and read separately. Queries, the *CLS command and device functions do not cause any changes to the contents of these registers. They can be cleared by entering a value of "0" (e.g. *ESE 0). The enable registers are non-volatile, and are only cleared by means of device shutdown if the non-volatile PSC flag is set to 1.

Designation	Setting Command	Query Command
Event standard enable reg. (ESE)	*ESE <i>n</i>	*ESE?
Parallel poll enable register (PRE)	*PRE <i>n</i>	*PRE?
Service request enable reg. (SRE)	*SRE <i>n</i>	*SRE?
Event enable register A (ERAE)	ERAE <i>n</i>	ERAE?
Event enable register B (ERBE)	ERBE <i>n</i>	ERBE?
Event enable register C (ERCE)	ERCE <i>n</i>	ERCE?

n = decimal equivalent of register content (0 ≤ *n* ≤ 255).

Sample Setting Command

Syntax: ***ESE *n***

Sample Query Command

Syntax: ***ESE?**
 Sample response string: ***ESE 255**

***ESR?, ERA?, ERB?, ERC? – Event Register Query**



Function

The event register provides information concerning events which have occurred within the device since the last query. They acquire and save status changes which have occurred for specific device functions. The corresponding bit is set in the event register when the respective event occurs.

For example, the CME command error bit is set in the ESR event standard register upon receipt of an incorrect programming command. This bit remains set, even if correct commands are subsequently transmitted to the device. The CME bit is not reset until the ESR register is queried.

The device is furnished with four 8-bit event registers, each of which can be individually queried. When an event register is queried, its content is deleted. The *CLS command (CLEAR STATUS) can be used to clear all event registers.

Designation	Query Command
Event standard register (ESR)	*ESR?
Event register A (ERA)	ERA?
Event register B (ERB)	ERB?
Event register C (ERC)	ERC?

Each response consists of a whole number 0 ≤ *n* ≤ 255, where *n* corresponds to the decimal equivalent of the content of the respective register.

An enable register is assigned to each event register.

***IDN? – Device Identification Query**



Function

In response to this query, the device identifies itself by providing information regarding manufacturer, type designation, serial number, hardware revision level and firmware revision level.

Query Command

Syntax: ***IDN?**
 Sample response string:
 "GMC-I GOSSEN-METRAWATT,
 PSP1500P060RU060P,xxxxxxxxxxxxxx,01.004"
manufacturer,
type,serial_number,hardware_revision,software_revision
 Fixed response string length: 63 characters

***IST? – Individual Status Query**



Function

Command for directly querying parallel poll information, derived from the status byte.
 The status byte is not reset by this query.

Query Command

Syntax: ***IST?**
 Response string: **0 or 1**

***LRN? – Device Settings Query (LEARN)**



*LRN? reads out current device settings.

*LRN? *i* (*i* = 1 through 12/15) reads out the respective device settings which have been saved to setup memories 1 through 12/15 [for a more precise formulation refer to command *SAV 1 through 12/15].

Function

In response to the *LRN? query command, the device supplies a list of nearly all adjustable functions along with current parameter settings.

Query Command

Syntax: ***LRN?**
 Sample response string (after *RST):
"OUTPUT OFF;USET +000,000;ISET +000,000;PSET +01500.0;UL_L +000,000;UL_H +060,000;IL_L +000,000;IL_H +060,000;OVP ON;OVSET +080,000;OV_DELAY 00,000;OCP OFF;OCSET +080,000;OC_DELAY 00,000;POWER_ON RST;T_MODE OFF,OFF;ANALOG_IN OFF, OFF;SINK ON;C_DYN R;MEAS_LPF 3;MINMAX OFF;SIG123 OFF, OFF, OFF;SSET OFF;FSET CLR;TDEF 00,001;TSET 00,000;START_STOP 0001.0001;REPETITION 000;DISPLAY UO, IO"

Variant: ***LRN? *i***

(*i*) = optional parameter, specifies address in setup memory #*i* = 1 - 12/15. ***LRN? *i*** reads the "*LRN?" data record out of setup memory (01 ≤ *i* ≤ 12/15).

Fixed response string length: 390 characters

*OPC, *OPC? – Operation Complete Query



Function

The operation complete function (OPC) allows for synchronization of the controller and the device:

Information indicating whether or not the previous instructions in the command string have been processed can thus be evaluated. There are two possible procedures:

Bit 0 is set in the *ESR register with the *OPC command.

Setting Command

Syntax: ***OPC**

A "1" is transmitted as a result following the *OPC? command.

Query Command

Syntax: ***OPC?**

Comment

Further evaluation options are described in the chapter entitled "Status and Events Management".

*PSC, *PSC? – Power-On Status Clear



Function

The power-on status clear flag (PSC) determines whether or not the contents of the enable registers will be cleared when the device is shut down.

The PSC flag can be set and queried:

Setting Command

Syntax: ***PSC n**
Value range: n = 0, 1
Default setting
or after RESET (*RST): 0

Query Command

Syntax: ***PSC?**
Sample response string: 0

Parameters List

Parameter	Content	Meaning
n	0	Enable registers will not be cleared
	1	Enable registers will be cleared

Comment

The PSC flag setting is retained, even after the device has been switched off or execution of the *CLS command.

*RCL – Recalling Stored Settings



Function

Settings which have been previously saved to battery-backed memory with the *SAV command (SAVE) can be recalled and activated with *RCL (RECALL).

Remarks

The function for recalling a device setting from setup memory can be used for other commands by entering a text parameter (Rxx).

Example: POWER_ON R01 means that the memory content of setup memory 1 is recalled at power-up.

Setting Command

Syntax: ***RCL n**

Parameters List

Register number n
n = 1 through 12/15
n = 99 (undo after *RST, *RCL #, ...)
Parameter type: numeric (whole number)

Recalls a parameter set from setup memory. Setting parameters stored to the specified register number are used for the current device settings: The status which was active before the **RCL n** command was executed can be restored with the **RCL 99** command.

*RST – Reset Device Settings to Default Values



Function

After executing the reset function, the device is set to its basic default configuration (see the table entitled "Adjustable Functions and Parameters" in chapter 10.1).

Note: A period of approximately 30 seconds should be allowed to elapse after the *RST command, before the next command is executed.

Default settings:

```
\OUTPUT OFF;USET +000,000;ISET  
+000,000;PSET +01500.0;UL_L +000,000;UL_H  
+060,000;IL_L +000,000;IL_H +060,000;OVP  
ON;OVSET +080,000;OV_DELAY 00,000;OCP  
OFF;OCSET +080,000;OC_DELAY 00,000;POW-  
ER_ON RST;T_MODE OFF,OFF;ANALOG_IN OFF,  
OFF;SINK ON;C_DYN R;MEAS_LPF 3;MINMAX  
OFF;SIG123 OFF, OFF, OFF;SSET OFF;FSET  
CLR;TDEF 00,001;TSET 00,000;START_STOP  
0001.0001;REPETITION 000;DISPLAY UO, IO"
```

```
UI_C_Set  
+000,000.+000,000.+000,000.+000,000
```

Setting Command

Syntax: ***RST**

*SAV – Saving Device Settings



Function

Current device settings can be saved to battery-backed memory with the *SAV (SAVE) execution command.

Setting Command

Syntax: ***SAV n**

Parameters List

Register number *n*

n = 1 through 12/15

Parameter type: numeric (whole number)

Comments

All data stored with the SAVE function are retained in battery-backed memory when the device is switched off.

*STB? – Status Byte Register Query



Function

Command for querying the status byte register (STB).

The status byte register contains:

- The status of group messages from the four event registers (bits 1, 2, 3 and 5)
- The status of the output buffer (empty → MAV bit = 0, not empty → MAV bit = 1)
- The status of MSS group messages masked with the SRE enable register from internal bits 0 through 5

This query command has been replicated to a great extent for operation with a serial interface (RS 232 or USB).

Register content can be read out:

a) With the *STB? command:

The response is a data string consisting of a whole number $16 \leq n \leq 127$, where *n* corresponds to the decimal equivalent of the register's content.

With this querying method the value of *n* is always ≥ 16 , because at least the response string was saved to the output buffer, and the MAV bit was thus set.

b) By means of serial polling (IEC bus only):

The device responds with its status byte as a "one byte message" in reply to the SPE (SERIAL POLL ENABLE) addressed interface command.

With this querying method bit 6 indicates the RQS status, and is reset to "0" after completion of serial polling.

The *CLS (CLEAR STATUS) command clears the status byte register except for the MAV bit, and cancels any SRQ messages.

*TRG – Device Trigger Function



Function

A command or a list of commands which has been previously defined by means of the *DDT string (DEFINE DEVICE TRIGGER) is executed with this command.

The device accepts this command as a device message via all integrated PC interfaces.

Setting Command

Syntax: ***TRG**

Comments

If trigger action has not been defined (empty DDT memory), bit 4 (EXE, execution error) is set in the standard event register upon receipt of the device trigger command.

The *TRG command may not be used as part of the DDT command.

The DDT register is not changed or cleared when the trigger command is executed.

*TST? – Starting the Self-Test



Function

Upon receipt of the *TST? query command, the device starts a self-test and reads out test results to the output buffer as a response string.

The *TST? query generates a response of either "0" (= test passed) or "1" (= test failed). If the self-test is failed, the "TCE" bit is also set in event register C.

The following is checked:

Balancing Test

Testing is conducted to determine whether or not the device has been balanced.

If the device has not been balanced, or if the balancing procedure was interrupted, error numbers 91 and 66 are read out.

Query Command

Syntax: ***TST?**

Response string: **0 or 1**

*WAI – Wait to Continue



Function

The *WAI command is of no significance for programming the KONSTANTER.

It serves to synchronize the interface protocol in accordance with the IEC 488.2 standard.

Setting Command

Syntax: ***WAI**

ADJUST – Balancing / Calibration Function

 Menu

Function



Attention!

This procedure replaces directly the reference parameters referring to the accuracy of the Konstanter. Please check carefully before starting this procedure.

The factory settet adjustment was done with high precise instruments as shown in DAkKS calibration certificate.

When starting the adjust function, the right display shows the last presetted calibration date (format Y.MM.DD)



Attention!

This procedure may only be executed if no other power consumers are connected. They might otherwise be damaged, because the upper range limits are read out automatically (OUTPUT ON).

The entire procedure can be executed either manually or PC controlled.

The following parameters can be balanced with this procedure: Voltage setpoint USET (offset value and upper range limit) and measured voltage value UOUT (offset value and upper range limit). Current setpoint ISET (offset value and upper range limit) and measured current value IOUT (offset value and upper range limit).

Sufficiently accurate measuring instruments for voltage and current are required for this procedure. The measured values must be entered as parameter W during the respective balancing step, either at the keypad or at the PC.

Appropriate error messages are generated and displayed as **UNCAL** if balancing fails or if it is interrupted with the **ADJUST EXIT** command.

ADJUST Procedure

The following sequence must be adhered to: Uoff (offset value), Ufs (upper range limit), Ioff (offset value), Ifs (upper range limit)

Setting Commands

Voltage offset

Syntax: **ADJUST Uoff**

The Konstanter selects a small voltage offset value.

Read measured value **w** at the measuring instrument and transmit it to the Konstanter with the following command.

Syntax: **ADJUST Uoff, w**

Upper voltage range limit

Syntax: **ADJUST Ufs**

The Konstanter sets output voltage to the upper range limit. Read measured value **w** at the measuring instrument and transmit it to the Konstanter with the following command.

Syntax: **ADJUST Ufs, w**

Current offset

Syntax: **ADJUST Ioff**

The Konstanter selects a small current offset value.

The Konstanter must be short circuited via the ammeter or connected to a suitable resistive load for current balancing.



Attention!

Change the test setup for current measurement with a suitable ammeter. The measuring instrument must be capable of processing the maximum occurring current value.

Read measured value **w** at the measuring instrument and transmit it to the Konstanter with the following command.

Syntax: **ADJUST Ioff, w**

Upper current range limit

Syntax: **ADJUST Ifs**

The Konstanter selects a small voltage offset value.

Read measured value **w** at the measuring instrument and transmit it to the Konstanter with the following command.

Syntax: **ADJUST Ifs, w**

After the procedure has been completed, the date from the internal clock is saved as a balancing date.

An error message is generated when the procedure is aborted or an error has occurred. In the adjust menu an **UNCAL** is displayed instead of the adjust date. The adjust parameters are replaced by internal default values.

The ***TST?** query generates a „1“.

After a new „power on“ the last active adjust parameters including its actual date are refreshed and becomes active.

The ***TST?** query generates a „0“.

Interrupting the balancing procedure

Syntax: **ADJUST EXIT**

ANALOG_IN, ANALOG_IN?

– Connection of Analog Control Inputs Uext, Iext (Uset, Iset)

 Menu

Function

This command allows for direct or linked connection of the analog control inputs for voltage and current.

The txt1 parameter determines the switching parameter for the Uext input, and the txt2 parameter applies to the Iext input.

The control inputs at the analog interface can be switched directly with the OFF and ON parameters.

The “ON/OFF” switching status can be set indirectly by entering the “SSET” parameter to the ANALOG_IN setting command, depending upon FSET (with the sequence function) or the SSET command.

When the switching statuses are queried, the momentary switching status, namely ON, OFF or SSET, is always returned as a response.

Note: While the PSET function is active, command signals Uext and Iext cannot be activated.

Setting Command

Syntax: **ANALOG_IN txt1,txt2**

Parameter txt1/txt2: OFF/ON/SSET

Default setting
or after RESET (*RST): OFF

Query Command

Syntax: **ANALOG_IN?**

Sample response string: **ANALOG_IN OFF, OFF**

C_DYN, C_DYN? – Setting Current Regulating Dynamics

 Menu

Function

This command makes it possible to adapt the control dynamics of the current regulator to inductive loads. Correct use of this command allows for optimization of the regulator for critical load circumstances.

Setting Command

Syntax: **C_DYN txt**

Parameters List

Parameter	Content	Meaning
txt	R	Full current regulating dynamics, for minimal inductive loads
	L	Reduced current regulating dynamics, for higher inductive loads or in case of parallel connection

Query Command

Syntax: **C_DYN?**

Sample response string: **C_DYN R**

CRA?, CRB? – Condition Register Query

 Menu

Function

The condition register provides information concerning the momentary status of specific device functions at the time the query was executed. For example, if the output is switched to constant current regulation, the appropriate CCR bit is set in condition register A (CRA) (condition TRUE → condition bit = 1). This bit remains set until the current regulating mode is exited. The condition register can be queried as often as desired during this time, without causing any change to its content. The corresponding bit is not reset until the output is no longer operating in the current regulating mode (condition FALSE → conditions bit = 0). The device is furnished with an 8-bit condition register. It can be read out, but direct overwriting and deletion are not possible.

Designation	Query Command
Condition Register A (CRA)	CRA?
Condition register B (CRB)	CRB?

The response consists of a whole number $0 \leq n \leq 255$, where n corresponds to the decimal equivalent of the register's content.

Query Command

Syntax: **CRA?**

Condition register A

D7:	SEQB	Sequence function active
D6:	OTP2A	Overtemperature shutdown (OTP LEVEL 2) active
D5:	OTP1A	Temperature signal (OTP LEVEL 1) active
D4:	OVPA	OVP signal active
D3:	OCPA	OCP signal active
D2:	OL	Overload
D1:	CCR	Output in current regulating mode
D0:	CVR	Output in voltage regulating mode

Query Command

Syntax: **CRB?**

Condition register B

D7:	TCB	TST or ADJUST/CAL function active
D6:	T2A	Signal at trigger input 2 of the analog interface active 2)
D5:	T1A	Signal at trigger input 1 of the analog interface active 2)
D4:	ACLL	AC LEVEL LOW (line voltage < 182 Vrms)
D3:	0	
D2:	S123A	Signal output SIG1 or/and signal output SIG2 or/and signal output SIG3 at the analog interface active
D1:	CMPC	Measured current value not within the current tolerance band specified by UI_C_SET w1.w2.w3.w4 divided by w3.w4; ENABLE: ?MINMAX ON?
D0:	CMPV	Measured voltage value not within the voltage tolerance band specified by UI_C_SET w1.w2.w3.w4 divided by w1.w2; ENABLE: ?MINMAX ON?

DCL, SDC – Device Clear Function

 —

Function

The device clear command causes clearing of the input and output buffers at the computer interfaces (e.g. requested data which have not been picked up). Interface-internal waiting times and lockouts are cleared. The device is ready to receive data.

Addressing status	Unchanged
Input and output buffers	Cleared
Service request SRQ	Unchanged
Status byte register	MAV bit = 0, otherwise unchanged
Event registers ESR, ERA, ERB, ERC	Unchanged
Enable registers ESE, ERAE, ERBE, ERCE, SRE, PRE	Unchanged
Set and stored parameters	Unchanged

This command is processed:

- As a device message via all computer interfaces (setting command) 'DCL' or 'SDC'

Syntax: **DCL**

or

Syntax: **SDC**

- Via the IEC bus interface as addressed command SDC (SELECTED DEVICE CLEAR)
- Via the IEC bus interface as universal command DCL (DEVICE CLEAR) for all bus users

DISPLAY, DISPLAY? – Function Switching for Displays A and B

 Menu

Function

The display function makes it possible to control displays A and B separately in accordance with the table below. If this view is exited, e.g. by selecting another parameter with SELECT, or with the rotary encoder or via the menu, the display returns to this configuration after the specified time has elapsed (DDC: see the table entitled "Adjustable Functions and Parameters" in chapter 10.1).

Setting Command

Syntax **DISPLAY txt1, txt2**

Default setting

or after RESET (*RST): UO, IO

Parameters List

Status	Description	Display A txt1	Display B txt2	Menu 
ON	7-segment display activated	X	X	dPY-Ab
OFF	7-segment display deactivated	X	X	dPY-Ab
UO	Output voltage Uout (default value)	X	—	dPY-A
US	Voltage setpoint Uset	X	—	dPY-A
PS	Power setpoint Pset	X	—	dPY-A
IO	Output current Iout (default value)	—	X	dPY-b
IS	Current setpoint Iset	—	X	dPY-b
PO	Output power Pout	—	X	dPY-b
—	Display switching time	—	—	ddc

The ON or OFF status does not change the selected display function.

Query Command

Syntax **DISPLAY?**

Sample response string: **DISPLAY UO, IS**

ERROR? – List of Error Messages

Menu

Function

The three last different error messages can be read out with this command. The content of the µC-RSTSRC registers is added as the fourth parameter

The error list can be reset with the ***CLS** command.

A description of the errors is included in the section entitled "System Messages".

Query Command

Syntax: **ERROR?**

Sample response string: **ERROR 031,098,000,001**
ERROR n1,n2,n3,n4

Explanation of the example:

Parameters List

Parameter	Content	Meaning
n1	031	Command error, CME (last error)
n2	098	Max. limit overflow (next to last error)
n3	000	No further errors
n4	001	The content of internal register µC-RSTSRC is added as additional information, although bits D7 through D5 are irrelevant. The value is not influenced by the "CLS" command.

Parameters List

Parameter	Content	Meaning
txt	CLR	Empty memory location, is ignored/skipped during execution. CLR in the data record of the stop address of a sequence switches the output off after the sequence has been completed.
	NF	Sequence values USET, ISET and TSET without additional function (switching function)
	RU	Voltage ramp, duration TSET or TDEF
	RI	Current ramp, duration TSET or TDEF
	SOFF	Additionally switches SSET to OFF
	S_ON	Additionally switches SSET to ON
	AUOF	Additionally switches analog input UEXT to OFF
	AUON	Additionally switches analog input UEXT to ON
	AUSS	Additionally switches analog input UEXT to SSET control
	AIOF	Additionally switches analog input IEXT to OFF
	AION	Additionally switches analog input IEXT to ON
	AISS	Additionally switches analog input IEXT to SSET control
	Rxx	Sequence chain; USET/ISET/TSET are ignored *; new device setup is loaded from setup memory xx (see *RCL n command) ! Thus all settings and parameters saved to Rxx apply. Additional chains are also possible, but without automatic return upon reaching the stop address. Value range: R01 to R12/15 Note: If a PSET function is active in the selected SETUP setting, the SEQUENCE function will be aborted.
Sxx	Invoke subsequence; USET/ISET/TSET setting is ignored *; ! Only the START_STOP, REPETITION and TDEF parameters from setup memory xx are used. Automatic return to the main sequence when the stop address of the subsequence is reached after the specified number of repetitions has been completed. No return occurs if continuous repetition has been selected for the subsequence. Maximum nesting depth: 1, Value range: S01 to S12/15	

* **Exception:** If the memory address is identical with the stop address of the sequence, the parameter values for USET and ISET are used as the final setting values when the sequence is completed or aborted.

FSET, FSET? – Sequence Function Parameter

Menu

Function

In addition to USET, ISET and TSET, FSET is the fourth parameter for defining the sequence memory.

It determines which function will be executed upon transition to the respective memory location.

Execution of the parameter is only possible during the course of a running sequence (similar to the TSET parameter).

When the FSET parameter is transmitted, the current FSET setting is determined and is saved to the respective specification by means of the SM_STORE command.

The parameters for the FSET command are also part of the STORE command.

Setting Command

Syntax: **FSET txt**

Default setting
or after RESET (*RST): CLR

Query Command

Syntax: **FSET?**

Sample response string: **FSET NF**

Parameters List see at the top of the next column.

GTL – GO-TO-LOCAL Function (as from Firmware Version 005)

ESC/LOCAL in „remote“ State

Function

The „GTL“ command leads to a return of device control to front plate operation, similar to activating the [LOCAL] key.

For serial interfaces (RS232 or USB), the command should not be chained with a query command as the remote state is restored in this case, i.e. when query data are issued.

This command is processed via all computer interfaces as device message.

Setting Command

Syntax: **GTL**

IFC – Resetting the IEC Bus Interface (interface clear)

—

Function

The IEC bus interface at the device is reinitialized with the IFC (INTERFACE CLEAR) bus interface command, and is returned to the standard default settings.

Addressing status	Not addressed
Input and output buffers	Unchanged
Service request SRQ	Unchanged
Status byte register STB	Unchanged
Event registers ESR, ERA, ERB, ERC	Unchanged
Enable registers ESE, ERAE, ERBE, ERCE, SRE, PRE	Unchanged
Set and stored parameters	Unchanged

Setting Command

Syntax: **IFC**

IL_H, IL_H? – Upper Limit Value for Current Setting

Menu

Function

IL_H defines the upper setting limit (soft-limit) for current setpoint value Iset.

The limit can be used to assure that output current is not inadvertently set above a specified value.

The IL_H command corresponds to the ILIM command for the SSP6XN Konstanter series as an upper limit value.

Thus **IL_H** can also be replaced with **ILIM**.

When the **ILIM?** query is executed, **IL_H +XXX.XXX** is returned in response.

Values outside of the value range ($I_{set} \leq w \leq I_{nom}$) are not accepted, and cause generation of an error message and setting of an error bit in event register ERC.2.

Inom is device-specific maximum nominal current.

Entered numeric values are rounded off to device-specific resolution.

Setting Command

Syntax: **IL_H w**
Value range: $I_{set} \leq w \leq I_{nom}$
Default setting
or after RESET (*RST): $w = I_{nom}$

Query Command

Syntax: **IL_H?**
Sample response string: **IL_H +XXX.XXX**

Comments

The IL_H function is not active for setting output current by means of control signal Iext via the analog interface.

IL_L, IL_L? – Lower Limit Value for Current Setting

Menu

Function

IL_L defines the lower setting limit (soft-limit) for current setpoint value Iset.

The limit can be used to assure that output current is not inadvertently set below a specified value.

Values outside of the value range ($0 \leq w \leq I_{set}$) are not accepted, and cause generation of an error message and setting of an error bit in event register ERC.2.

Inom is device-specific maximum nominal current.

Entered numeric values are rounded off to device-specific resolution.

Setting Command

Syntax: **IL_L w**
Value range: $0 \leq w \leq I_{set}$
Default setting
or after RESET (*RST): $w = 0$

Query Command

Syntax: **IL_L?**
Sample response string: **IL_L +XXX.XXX**

Comments

The IL_L function is not active for setting output current by means of control signal Iext via the analog interface.

IMAX? – Maximum Measured Current Value

Menu

Function

The IMAX function reads out the highest output current value which was measured by the IOUT measuring function and saved to Min-Max memory while the MINMAX function was set to ON.

If the measured current value has exceeded the measuring range limit at least once with the MINMAX function set to ON, "+OL" appears at the display for IMAX and "+999999." is entered to the data string.

The Min-Max memory value can be reset to the momentarily measured value with **MINMAX RST** (for all 4 parameters at once).

Query Command

Syntax: **IMAX?**
Sample response string: **IMAX +XXX.XXX**

IMIN? – Minimum Measured Current Value

Menu

Function

The IMIN function reads out the lowest output current value which was measured by the IOUT measuring function and saved to Min-Max memory while the MINMAX function was set to ON.

If the measured current value has fallen below the measuring range limit at least once with the MINMAX function set to ON, "-OL" appears at the display for IMIN and "-999999." is entered to the data string. The Min-Max memory value can be reset to the momentarily measured value with MINMAX RST (for all 4 parameters at once).

Query Command

Syntax: **IMIN?**
Sample response string: **IMIN +XXX.XXX**

IOUT? – Querying the Momentary Current Value

SELECT B

Function

The IOUT? function reads out the momentary measured value for output current.

Type Nominal current	Current Measuring Range		Resolution
	Min. [A]	Max. [A]	
60 A	-032.766	+098.300 A	2 mA
120 A	-065.532	+196.600 A	4 mA
180 A	-098.298	+294.900 A	6 mA

The upper range values may change minimally after balancing!

If the measuring range is exceeded or fallen short of, "+/-OL" is displayed or "+/-999999" is entered to the data string.

Query Command

Syntax: **IOUT?**
Sample response string: **IOUT +XXX.XXX**

ISET, ISET? – Current Setpoint

 SELECT B or rotary encoder Iset

Function

The output current setpoint is set with ISET. The ISET? query returns the momentarily selected current setpoint as a response. Values outside of the value range ($0 \leq IL_L \leq w \leq IL_H \leq I_{nom}$) are not accepted, and cause generation of an error message and setting of an error bit in event register ERC.2.

Entered numeric values are rounded off to device-specific resolution.

Setting Command

Syntax: **ISET w**
 Value range: $0 \leq IL_L \leq w \leq IL_H \leq I_{nom}$
 Default setting
 or after RESET (*RST): $w = 0$

Query Command

Syntax: **ISET?**
 Sample response string: **ISET +xxx.xxx**

Device Type	Setting Range		Setting Resolution		
	Nom. Current [A]	Min. [A]	Max. [A]	Remote [A]	Manual [A]
60	0.000	60.000	0.001	0.001	
120	0.000	120.000	0.002	0.002/0.010	
180	0.000	180.00	0.003125	0.003125/0.0125	

MEASURE, MEASURE? – Measuring Function (not currently used)

 Menu

MEAS_LPF, MEAS_LPF? – Low-Pass Filter for Measured Value

Acquisition

 Menu

Function

Selection can be made from amongst four time constants for evaluation of the measuring signal. This selection applies equally to the measured quantities for both voltage and current.

Setting Command

Syntax: **MEAS_LPF n**
 Value range: $n = 1, 2, 3, 4$
 Default setting
 or after RESET (*RST): $n = 3$

Query Command

Syntax: **MEAS_LPF?**
 Sample response string: **MEAS_LPF n**

Parameters List

Parameter	Content	Meaning, Time Constant
n	1	1 ms
	2	10 ms
	3	50 ms
	4	400 ms

MINMAX, MINMAX? – Min-Max Storage for Measured U and I Values

 Menu

Function

The MINMAX function makes it possible to save minimum and maximum measured voltage and current values to memory. The saved values, UMIN, UMAX, IMIN and IMAX, can then be displayed or queried via the interfaces.

The “MINMAX ON” setting is also a prerequisite for the “tolerance band function” (setting command **UI_C_SET w1, w2, w3, w4** for the reference values).

Setting Command

Syntax: **MINMAX txt**
 Parameter txt: OFF/ON/RST
 Default setting
 or after RESET (*RST): **OFF**

Query Command

Syntax: **MINMAX?**
 Sample response string: **MINMAX OFF**

Parameters List

txt	Description
OFF	Storage of Min-Max values deactivated, stored values remain unchanged
ON	Storage of Min-Max values activated, enables tolerance band function for CRB.0/1, ERC.0/1. If the SIG outputs are correspondingly configured, a switching signal can be generated at the analog interface.
RST	Contents of Min-Max memory are reset, i.e. are replaced with the momentary measured value for the corresponding parameter: Umin = Uout Umax = Uout Imin = Iout Imax = Iout

MODE? – Momentary Control Mode of the Power Output

 LED

Function

The device responds with the momentarily active operating mode (control mode) in response to the MODE? query command.

Query Command

Syntax: **MODE?**
 Sample response string: **MODE CV**

Parameters List

Parameter	Content	Meaning	LED 
txt	OFF	Output deactivated	—
	CV	Constant voltage regulating mode	CV + OUTPUT
	CC	Constant current regulating mode	CC + OUTPUT
	CP	Constant power regulating mode Overload (power limiting)	PLim + OUTPUT

OCP, OCP? – Overcurrent Protection

Menu, LED

Function

The OCP function (over current protection) determines how the power output will respond if load current climbs to the selected OCSET value.

The OCP function is used in addition to current regulation, whose setpoint is specified with ISET or via the analog control input.

The OCP function protects connected power consumers against continuous overcurrent, although a higher current value is required intermittently. The function also makes it possible to activate another device configuration in case of overcurrent.

Load current is compared with the OCSET value generated with an integrated D-A converter by means of an autonomous comparator, and is evaluated.

The ensuing reaction is shown in the following table.

Activation of the OCP function is indicated at the front panel by means of the “OCP ON” LED. If OCP has caused shutdown, this is additionally indicated by the “OCP” LED.

Setting Command

Syntax: **OCP txt**
Parameter txt: OFF/ON/R01 ... R12/15
Default setting
or after RESET (*RST): OFF

Query Command

Syntax: **OCP?**
Sample response string: **OCP OFF**

Parameters List

Parameter	Content	Meaning
txt	OFF	OCP function is inactive
	ON	OCP function activated: The output is shut down if output current is equal to or exceeds the specified OC_SET limit value for a duration of OC_DELAY.
	Rxxx	Instead of a shutdown, recall of a device configuration from setup memories 01 through 12/15 can be activated with R01 ... R12/15.

OCSET, OCSET? – Overcurrent Protection Trigger Value

SELECT B, Menu

Function

The triggering threshold reference value required for the OCP function is set with OCSET.

Setting Command

Syntax: **OCSET w**
Value range: $OCSET_{min} \leq w \leq OCSET_{max}$
Default setting
or after RESET (*RST): $OCSET_{max}$

Device Type	Setting Range		Setting Resolution	
	Nom. Current [A]	OCSETmin. [A]	OCSETmax. [A]	Remote [A]
60	3.00	80.00	0.02	0.02
120	6.00	160.00	0.05	0.05
180	9.00	240.0	0.1	0.1

Query Command

Syntax: **OCSET?**
Sample response string: **OCSET +080.000**

OC_DELAY, OC_DELAY? – Overcurrent Protection Trigger Delay

Menu

Function

Desired response delay for the OCP function is set with OC_DELAY. Delay time is specified in seconds.

If output current drops to below the OCSET value before OC_DELAY expires, the shutdown sequence is interrupted and restarted the next time the threshold is exceeded.

Setting Command

Syntax: **OC_DELAY w**
Value range: $0 \leq w \leq 65,535$
Default setting
or after RESET (*RST): 0

Query Command

Syntax: **OC_DELAY?**
Sample response string: **OC_DELAY XX.XXX**

OUTPUT, OUTPUT? – Switching the Power Output On and Off

OUTPUT / LED

Function

The power output can be activated and deactivated with the OUTPUT function.

Activation: OUTPUT ON:

Current and voltage values of “0” are specified initially for a period of approximately 2 ms **with activated output** for the transition from the “highly resistive” condition. The output is then adjusted to the selected voltage and current setpoints.

Deactivation: OUTPUT OFF:

The power output is deactivated and rendered highly resistive with the OUTPUT OFF command. Differentiation must be made as to whether the internal dynamic sink is on or off (setting command: SINK on / SINK OFF).

However, the output terminals are not electrically enabled.

OUTPUT OFF with SINK ON

The setpoints for voltage and current are set to 0 V and 0 A. The sink is activated for approximately 300 ms. The sink discharges the output capacitors as far as possible. The sink is then switched off and the output becomes highly resistive as a result.

OUTPUT OFF with SINK OFF

The setpoints for voltage and current are set to 0 V and 0 A. The power output is deactivated and becomes highly resistive as a result.

The output capacitors are discharged via the connected load only. Output voltage is correspondingly reduced.

Setting Command

Syntax: **OUTPUT txt**
Parameter txt: OFF/ON
Default setting
or after RESET (*RST): OFF

Query Command

Syntax: **OUTPUT?**
Sample response string: **OUTPUT ON**

Parameters List

Parameter	Content	Meaning
txt	OFF	Output is switched off, OUTPUT LED off, control mode LEDs are off
	ON	Output is switched on, OUTPUT LED lights up, control mode LED lights up

Comments

If the output is switched off by a trigger signal in the “T_MODE OUT” operating mode, i.e. in the off state, the signal has higher priority.

An OUTPUT ON command is not executed, and bit 4 is set in event register B (OUTE).

“Err 073” also appears briefly at the display as a warning in the event of manual operation.

Additional functions which may influence the status of the output include:

- OTP, overtemperature protection
- OVP, overvoltage protection
- OCP with activated “OCP ON” parameter
- SEQUENCE function
- T_MODE function
- POWER_ON
- *RCL

OVP, OVP? – Overvoltage Protection

Menu, LEDs

Edit Formulation Function

The OVP function (**over voltage protection**) specifies how the power output will respond if output voltage is equal to or exceeds the selected OVSET value.

The OVP function is an overriding protective function and is independent of the voltage and current regulators.

The OVP function protects connected power consumers against continuous overvoltage, although higher voltage is required intermittently. The function also makes it possible to activate another device configuration in case of overvoltage.

Output voltage is compared with the OVSET value from the OVP-DAC by an autonomous comparator.

The ensuing reaction is shown in the following table, and execution can be delayed by means of OV_DELAY.

Where OV_DELAY = 0, the power output is switched off directly by the OVP comparator.

Activation of the OVP function is indicated at the front panel by means of the “OVP ON” LED.

If OVP has caused shutdown, this is additionally indicated by the “OVP” LED.

Setting Command

Syntax: **OVP txt**
Parameter txt: OFF/ON/R01 ... R12/15
Default setting
or after RESET (*RST): ON

Query Command

Syntax: **OVP?**
Sample response string: **OVP OFF**

Parameters List

Parameter	Content	Meaning
txt	OFF	OVP function inactive
	ON	OVP function activated: The output is shut down if output voltage is equal to or exceeds the specified OV_SET limit value for a duration of OV_DELAY.
	Rxxx	Instead of a shutdown, recall of a device configuration from setup memories 01 through 12/15 can be activated with R01 ... R12/15.

OV_DELAY, OV_DELAY? – Overvoltage Protection Triggering Delay

Menu

Function

Desired response delay for the OVP function is set with OV_DELAY. Delay time is specified in seconds.

If output voltage drops to below the OVSET value before OV_DELAY expires, the shutdown sequence is interrupted and restarted the next time the threshold is exceeded.

Where OV_DELAY = 0, the OVP comparator switches the power output off directly as well.

Setting Command

Syntax: **OV_DELAY w**
Value range: 0 ≤ w ≤ 65,535
Default setting
or after RESET (*RST): 0

Query Command

Syntax: **OV_DELAY?**
Sample response string: **OV_DELAY xx . xxx**

OVSET, OVSET? – Overvoltage Protection Trigger Value

 SELECT A and Menu

Function

The triggering threshold reference value required for the OVP function is set with OVSET.

Setting Command

Syntax: **OVSET w**
Value range: $OVSET_{min} \leq w \leq OVSET_{max}$
Default setting
or after RESET (*RST): $OVSET_{max}$

Query Command

Syntax: **OVSET?**
Sample response string: **OVSET +080.000**

Parameters List

Parameters	For: Device Type	Setting Range		Setting resolution	
	Nom. Voltage [V]	OVSETmin. [V]	OVSETmax. [V]	Remote [V]	Manual  [V]
w	60	3.00	80.00	0.02	0.02

Comments

Amongst other causes, overvoltage protection can be triggered by:

- $USET \geq OVSET$ (due to manual setting, programming command, memory recall, sequence run or Uset control signal to the analog interface)
- Sensing leads with reversed polarity
- Interrupted output lead during sensing mode operation
- Interference from the power consumer
- Parallel connected voltage sources
- Dynamic output voltage overshooting
- Device malfunction or defect

POUT? – Querying Momentary Output Power

 SELECT B and Menu

Function

The POUT? function reads out momentary output power as the product of output voltage and output current.

Query Command

Syntax: **POUT?**
Sample response string: **POUT +XXXXX.X**

Measuring range: Due to the fact that the UOUT and IOUT measuring functions are utilized, the respective measuring ranges apply for power measurements as well. If one or both of the measured quantities UOUT and IOUT violate their respective measuring ranges, the product of POUT (UOUT x IOUT) is displayed as “-OL” or “OL”, or “+/-999999” is entered to the data string.

POWER_ON, POWER_ON? – Response After Power On

 Menu

Function

The POWER_ON function determines the status of device settings after mains power has been switched on.

Setting Command

Syntax: **POWER_ON txt**
Parameter txt: RST/SBY/RCL/R01 ... R12/15
Default setting
or after RESET (*RST): RST

Query Command

Syntax: **POWER_ON?**
Sample response string: **POWER_ON RST**

Parameters List

Parameter	Content	Meaning
txt	RST	RESET: Defined default settings are utilized → default settings
	SBY	STANDBY: Same device settings as before shutdown, but the power output remains inactive (OUTPUT OFF)
	RCL	RECALL: Same device settings as before shutdown – power output remains in previous state
	Rxx	Recall a device configuration saved to setup memory under XX

PSET, PSET?

 SELECT A

Function

The PSET Function¹⁾ is activated by preselecting a PSET parameter value < Pnom.

The PSET operating mode is indicated by the active green „CP-LED“¹⁾, query „MODE?“ leads to reply „MODE CP“.

(The condition and event register queries „CRA?“ and „ERA?“ invariably supply the control status of the power section and are to be interpreted accordingly.)

By using the measuring functions, setting values for voltage and current are temporarily calculated and read out to the digital-analog converters for the specified load. The „digital control range“ is limited by settings USET and ISET. If the setpoint value PSET cannot be achieved for the connected load, it is additionally indicated by the LED „CV“ or „CC“.



Attention!

Activation of PSET **automatically** switches off the analog command inputs Uext and Iext, i. e. corresponding to „ANALOG_IN OFF, OFF“. The PSET function cannot be combined with the SEQUENCE function!

Setting Command

Syntax: **PSET w**
Value range: $0 \leq w \leq P_{nom}$
 $w = P_{nom}$ (no power control)

Default setting

and/or after RESET (*RST): $w = P_{nom}$ ²⁾

Query Command

Syntax: **PSET?**
PSET +XXXXX.X
Sample response string: **PSET +01499.9**

¹⁾ „Power control“, available as from firmware version 004

²⁾ After „*RST“, the maximum possible output power of the device can be queried with query command PSET?. Depending on whether the device is operated with 115 Vac or 230 Vac mains power, the query supplies $P_{nom}/2$ or P_{nom} .

REPETITION, REPETITION? – Number of Repetitions for Sequence Function

Menu

Function

The REPETITION parameter determines how many times a sequence will be repeated, which is defined by the current START and STOP addresses.

i is an optional parameter which addresses the setup memory (1 to 12/15) to which the repetition value will be written, and from which it will be read.

Setting Command

Syntax: **REPETITION n(, i)**
 Value range: $0 \leq n \leq 255$
 Default setting or after RESET (*RST): 0

Query Command

Syntax: **REPETITION? (i)**
 Sample response string: **REPETITION n**

Parameters List

Parameter	Content	Meaning
n	0	Continuous repetition
	1 to 255	Number of sequence repetitions

RLOAD? – Load Resistance

Menü

Function

The RLOAD function supplies the value of the current load resistance as a quotient of output voltage and output current.

Query Command

Syntax: **RLOAD?**
 Sample response string: **RLOAD +XXX.XXX**

Measuring range: As the UOUT and IOUT measuring functions are used, the corresponding measuring range limits apply.

If the output is inactive (OUTPUT OFF) or one (or both) measuring quantities UOUT and/or IOUT exceed or fall short of the measuring range limits or if the mathematical value cannot be displayed in the numerical format „XXX.XXX“, RLOAD = UOUT / IOUT is shown for the quotient in the „OL“ display and „999999.“ is entered in the data string.

SEQUENCE, SEQUENCE? – Automatic Sequential Recall of Stored Setting Values, Sequence Status Query

Menu

Function

The sequence function makes it possible to generate voltage and current profiles over a period of time, for example in order to create test signals.

The required setting values and parameters are saved to the appropriate memory to this end.

Values are saved with the commands **SM_STORE ADR** or **STORE ADR, USET, ISET, TSET, FSET**. 1536/1700 memory locations are available for this function. If dwell time is set to TSET = 0, an overriding TDEF becomes effective.

The following control commands determine the course of the sequence. The sequence is defined by means of START and STOP addresses (**START_STOP xxxxx, xxxxx**), and the number of repetitions (**REPETITION n**).

Note: With appropriate configuration, sequence control (GO/STOP or START/STEP) is also possible via the trigger inputs (analog interface).

The SEQUENCE function cannot be combined with the PSET function!

Setting Command (sequence control command)

Syntax: **SEQUENCE txt**

Control Parameters List

If an addressed memory location is empty (no executable content), the sequence jumps to the next higher executable memory location.

Parameter	Content	Meaning
txt	OFF	Jump to stop address and end the sequence run or step-by-step control; same as stop. If there is no content (CLR), the power output is switched (OUTPUT OFF).
	GO	Start sequence run as of start address
	HOLD	Pause, suspend sequence at current memory location
	CONT ₂	Resume automatic sequence run with next executable memory location
	STRT ₁	Jump to start address and execute its content. Power output is switched on, step-by-step control is possible.
	STEP _{1,2}	Execute the next valid memory location. In the case of step-by-step control, the "repetition" parameter is ignored, i.e. a subsequence, for example, is executed only once.
	BSTP ₁	The "repetition" parameter is ignored, subsequences are skipped, ramp functions are executed just like "NF"
	STOP ₁	Jump to stop address and end the sequence run or step-by-step control. If there is no content (CLR), the power output is switched (OUTPUT OFF).
	ESC	Sequence is ended using the momentary setting without jumping to the final value.

1 Step-by-step control (remote / manual)

If the T_MODE parameter is set to "RCL", the step pulse can be specified by means of an external signal applied to the appropriate trigger input at the analog interface.

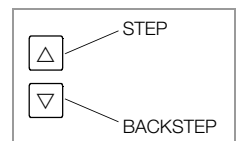

2 A memory address can be specified as an additional, optional parameter for these commands, as of which sequence execution is started or resumed.

Example:

SEQUENCE CONT, n where start address $\leq n \leq$ stop address

Query Command (sequence status)

Syntax: **SEQUENCE?**
 Sample response string: **SEQUENCE txt, n1, n2, n3**

Query parameters list

Parameter	Content	Meaning – Sequence Status
txt	RDY	Device in initial state, sequence run completed
	HOLD	Sequence run paused
	RUN	Sequence run is active
n1	000	The run is part of the main sequence.
	001 ... 012/015	The run is part of a subsequence; defined in the specified setup memory location (1 to 12/15).
n2	001 ... 255 999	Remaining number of repetitions, continuous repetition
n3	0001 ... 1536/ 1700	Momentarily executed memory location

SIG123, SIG123? – Analog Interface Signal Outputs

 Menu

Function

Two **floating** signal outputs (SIG 1 and SIG 2) and one signal output with reference to AGND 2 (SIG 3) are provided at the analog interface. They can be used to trigger control functions in the application. Different device functions and statuses can be assigned to these signals.

Setting Command

Syntax: **SIG123 txt1,txt2,txt3**
Default setting
or after RESET (*RST): OFF

Query Command

Syntax: **SIG123?**
Sample response string: **SIG123 txt1.txt2.txt3**

Parameters List

Parameter	Content	Meaning – Assignment	Level
txt n	OFF	SIG n: direct off	Passive high
	ON	SIG n: direct on	Active low
	OUT	OUTPUT ON OUTPUT OFF	Passive high Active low
	MODE	OFF or CV CC or OL	Passive high Active low
	SEQ	READY/STOP RUN	Passive high Active low
	SSET	OFF ON	Passive high Active low
	U_LO ¹	$U_{meas} \geq w1$ $U_{meas} < w1$	Passive high Active low
	U_HI ¹	$U_{meas} \leq w2$ $U_{meas} > w2$	Passive high Active low
	I_LO ¹	$I_{meas} \geq w3$ $I_{meas} < w3$	Passive high Active low
	I_HI ¹	$I_{meas} \leq w4$ $I_{meas} > w4$	Passive high Active low

¹ The signal outputs can be logically linked using the comparison function. The reference values are defined by parameters **w1**, **w2**, **w3** and **w4** from the **UI_C_SET** command. Momentary measured voltage and current values are compared with these parameters and evaluated.

Parameter	Meaning in UI_C_SET Command
w1	Lower voltage reference value
w2	Upper voltage reference value
w3	Lower current reference value
w4	Upper current reference value

SINK, SINK? – Sink Function On/Off

 Menu

Function

The device is equipped with a sink function for improved dynamic characteristics, which can be activated or deactivated as desired. After an **OUTPUT OFF** command, the sink is deactivated (if initially activated) after a specified period of time (300 ms).

Setting Command

Syntax: **SINK txt**
Parameter txt: OFF/ON
Default setting
or after RESET (*RST): ON

Query Command

Syntax: **SINK?**
Sample response string: **SINK txt**

SM_LOAD – Load Sequence Memory Location

 Menu

Function

The content of a memory location can be loaded in a targeted fashion with the **SM_LOAD** command. The **USET**, **ISET**, **TSET** and **FSET** parameters are entered to the current device settings during this procedure. **USET** and **ISET** are read out at the power output in the case of **OUTPUT ON**.

Setting Command

Syntax: **SM_LOAD n**
Value range: $1 \leq n \leq 1536/1700$

SM_STORE – Store to Sequence Memory Location

 Menu

Function

The contents of the **USET**, **ISET**, **TSET** and **FSET** parameters from the current device settings can be written to the specified memory location with the **SM_STORE** command.

The range of memory locations between the start and stop addresses can be cleared with the **SM_STORE 0** command. These memory locations are then in the empty state (**CLR**).

Setting Command

Syntax: **SM_STORE n**
Value range: $1 \leq n \leq 1536/1700$
Special case $n = 0$ (delete range)

SSET, SSET? – Command for an Assigned Switching Function (signal level switching function)

 Menu, SSET Key

Function

The **SSET** switching status can be controlled with the **SSET** setting command or with the corresponding **FSET** parameter (**S_ON/SOFF**) of the sequence function. The **SSET** switching function can then be linked with analog interface functions for switching the signal outputs **SIGx** (command: **SIG123**) and/or for controlling the analog inputs **Uext** and **Iext** (command: **ANALOG_IN**).

Setting Command

Syntax: **SSET txt**
Parameter txt: OFF/ON
Default setting
or after RESET (*RST): OFF

Query Command

Syntax: **SSET?**
Sample response string: **SSET txt**

START_STOP, START_STOP? – Memory Location Start and Stop Addresses for the Sequence Function

 Menu

Function

The start and stop addresses of the sequence to be executed are defined with the START_STOP command. The STOP address must be equal to or greater than the START address.

i is an optional parameter which addresses the setup memory (1 to 12/15) to which the START-STOP values will be written, and from which they will be read.

Setting Command

Syntax: **START_STOP n1,n2(,i)**
 Value range: $1 \leq n1 \leq n2 \leq 1536/1700$
 Default setting or after RESET (*RST): 1.1

Query Command

Syntax: **START_STOP? (i)**
 Sample response string: **START_STOP n1,n2**

STORE, STORE? – Transferring Parameters Directly to Memory

 (Menu – in sequential order of entry)

Function

This command is used to write the USET, ISET, TSET and FSET parameters directly to a memory location in order to set up a sequence. The parameters must be entered one after the other via the edit menu.

Setting Command

Syntax: **STORE n,w1,w2,w3,txt**

Parameters List

Parameter	Content	Formats / Meaning
n	1 to 1536/1700	Memory address
w1	$0 \leq w1 \leq \text{Unom}$	+nnn.nnn [V] voltage setpoint USET
w2	$0 \leq w2 \leq \text{Inom}$	+nnn.nnn [A] current setpoint ISET
w3	0 $0 \text{ [s]} < w3 \leq 65.535 \text{ [s]}$	w3 = 0: TSET executes TDEF nn.nnn [s] dwell time TSET
txt	Content from table for FSET	FSET function This parameter is identical to the setting options for the FSET command.

Query Command

Syntax: **STORE?**
 Syntax: **STORE? n**
 Syntax: **STORE? n1,n2**
 Syntax: **STORE? n1,n2,tab**

The response includes the entire parameter set for each memory location:
STORE n,w1.w2.w3.txt

Parameters List

Depending upon which query command is selected, one of the following responses is generated:

Command	Value Range	Meaning – Response
Store?		Query contents of a memory range from the start address to the stop address of the current sequence
Store? n	n = 1 to 1536/1700	Query contents of memory location n
Store? n1,n2	n1, n2 $= 1 \text{ to } 1536/1700$ $n2 \geq n1$	Query contents of a memory range from address n1 to address n2
Store? n1,n2,tab	n1, n2 $= 1 \text{ to } 1536/1700$ $n2 \geq n1$	Query contents of a memory range from address n1 to address n2 Delimiter between output parameters: tabulator character (hex code: 09h), decimal delimiter = decimal comma (hex code: 2Ch), line break (hex code: 0Ah)

TDEF, TDEF? – Default Time for SEQUENCE Function

 Menu

Function

The TDEF parameter setting defines the dwell time default setting for a voltage-current value pair to be recalled.

TDEF is used instead of TSET if TSET has not been set to any specific value, but rather to 0 [s].

Note: Use of TDEF is advantageous if one or several identical dwell times occur within a given sequence whose values need to be changed frequently.

i is an optional parameter which addresses the setup memory (1 to 12/15), to which the TDEF value will be written, and from which it will be read.

Setting Command

Syntax: **TDEF w(,i)**
 Value range: $0.001 \leq w \leq 65.535 \text{ [s]}$
 Default setting or after RESET (*RST): 0.001

Query Command

Syntax: **TDEF? (i)**
 Sample response string: **TDEF w**

TIMEDATE, TIMEDATE? – Programmable System Clock (RTC)

 Menu

Function

System date and time in accordance with ISO 8601 can be entered to the device with this command. The date entered here is used for device balancing (ADJUST command).

Setting Command

Syntax: **TIMEDATE yyyy-mm-ddThh:mm:ss**
 Default setting or after RESET (*RST): Remains unchanged

Query Command

Syntax: **TIMEDATE?**
 Sample response string: **TIMEDATE yyyy-mm-ddThh:mm:ss**
TIMEDATE 2007-10-01T08:00:05

The specified format must be adhered to:

yyyy: year (2000 ...)

– Delimiter (“-”)

mm: month (01 ... 12)

– Delimiter (“-”)

dd: day (01 ... 31)

T: delimiter (“T”)

hh:mm:ss hours:minutes:seconds

T_MODE, T_MODE? – Function Selection for the Trigger Inputs

Menu

Function

Two floating trigger inputs are provided at the analog interface, whose action can be defined independent of each other. In this way, control functions can be triggered at the device from the application.

Depending upon which function is selected, the trigger input is level or edge controlled.

Note: Detailed descriptions of the control level are included in the section entitled “Analog Interface”.

Setting Command

Syntax: **T MODE txt1,txt2**
Default setting
or after RESET (*RST): OFF

Query Command

Syntax: **T MODE?**
Sample response string: **T MODE txt1.txt2**

Parameters List

Parameter	Content	Meaning	Level controlled	LED ¹
txt n	OFF	Trigger input function deactivated	X	
	OUT	Trigger input acts upon the output: output on/off	X	OUTPUT
	SQS	RECALL: memory recall (step-by-step), edge controlled, time dependent (functions like SEQUENCE STEP)		SEQ STS
	SEQ	SEQUENCE: sequential memory recall (functions like SEQUENCE GO)	X	SEQ STS
	LLO	LOCAL LOCKED: front panel disabling	X	LCL LOCKED
	MIN	MINMAX: min-max memory for measured values	X	
	AIX	Analog input UEXT, IEXT	X	Uext ON
	AIU	Analog input UEXT	X	Uext ON
	AII	Analog input IEXT	X	Iext ON

¹ The associated TRGx LED lights up along with the selected trigger input if the trigger parameter is not set to OFF and the trigger input is active.

TSET, TSET? – Memory Location Specific Dwell Time for the SEQUENCE Function

Menu

Function

The TSET setting parameter defines the memory location specific dwell time for reading out a pair of voltage and current values for a sequence. If no specific value, but rather 0 [s], is assigned to TSET, TDEF is used as a default value for execution of the sequence function.

Setting Command

Syntax: **TSET w**
Value range: $0,000 \leq w \leq 65,535$ [s]
Default setting
or after RESET (*RST): 0.000

Query Command

Syntax: **TSET?**
Sample response string: **TSET w**

Comments

If dwell times of greater than 65.535 seconds are required, this can be achieved by specifying the same voltage and current values for several consecutive memory locations.

Another possibility is to invoke subsequences with the corresponding number of repetitions.

UI_C_SET, UI_C_SET? – Reference Values for Uout/Iout Tolerance Band Function

Menu



Attention!

While uploading the basic settings using the „write to device“ function in the „Notes“ tab of the Soft Front Panel the saved parameters of the function „UI_C_SET“ will be replaced by the current configuration.

Function

This function makes it possible to set up reference values for voltage and current, which are continuously compared with momentary measured values. In this way, for example, checking is possible in order to determine whether or not actual voltage and current values lie within the specified range (tolerance band function). The results of this comparison can be queried in condition register CRB?, bits 0 and 1, and in event register ERC?, bits 0 and 1. The results can also be assigned to signal outputs SIG123 at the analog interface with the help of the **SIG123 txt1.txt2.txt3** command.

Setting Command

Syntax: **UI_C_SET w1,w2,w3,w4**
Value range w1, w2: $0 \leq w1 < w2 \leq U_{nom}$ [V]
Value range w3, w4: $0 \leq w3 < w4 \leq I_{nom}$ [A]
Default setting
or after RESET (*RST): 0,U_{nom},0,I_{nom}

Query Command

Syntax: **UI_C_SET?**
Sample response string: **UI_C_SET w1,w2,w3,w4**

Parameters List

Parameters	Format	Meaning
w1	nnn.nnn [V]	Lower voltage reference value
w2	nnn.nnn [V]	Upper voltage reference value
w3	nnn.nnn [A]	Lower current reference value
w4	nnn.nnn [A]	Upper current reference value

UL_H, UL_H? – Upper Limit Value for Voltage Setting

Menu

Function

UL_H defines the upper setting limit (soft-limit) for voltage setpoint value Uset. The limit can be used to assure that output voltage is not inadvertently set above a specified value.

The UL_H command corresponds to the ULIM command for the SSP6XN Konstanter series as an upper limit value.

Thus **UL_H** can also be replaced with **ULIM**.

When the **ULIM?** query is executed, **UL_H +xxx.xxx** is returned as a response. Values outside of the value range ($U_{set} \leq w \leq U_{nom}$) are not accepted, and cause generation of an error message and setting of an error bit in event register ERC.2. U_{nom} is the device-specific maximum nominal voltage. Entered numeric values are rounded off to device-specific resolution.

Setting Command

Syntax: **UL_H w**
Value range: $U_{set} \leq w \leq U_{nom}$
Default setting
or after RESET (*RST): $w = U_{nom}$

Query Command

Syntax: **UL_H?**
Sample response string: **UL_H +xxx.xxx**

Comments

The UL_L function is not active for setting output current by means of control signal Iext via the analog interface.

UL_L, UL_L? – Lower Limit Value for Voltage Setting

 Menu

Function

UL_L defines the lower setting limit (soft-limit) for voltage setpoint value Uset.

The limit can be used to assure that output voltage is not inadvertently set below a specified value.

Values outside of the value range ($0 \leq w \leq Uset$) are not accepted, and cause generation of an error message and setting of an error bit in event register ERC.2.

Unom is the device-specific maximum nominal voltage.

Entered numeric values are rounded off to device-specific resolution.

Setting Command

Syntax: **UL_L w**
Value range: $0 \leq w \leq Uset$
Default setting
or after RESET (*RST): $w = 0$

Query Command

Syntax: **UL_L?**
Sample response string: **UL_L +XXX.XXX**

Comments

The UL_L function is not active for setting output voltage by means of control signal Uext via the analog interface.

UMAX? – Maximum Measured Voltage Value

 Menu

Function

The UMAX function reads out the highest output voltage value which was measured by the Uout measuring function and saved to Min-Max memory while the MINMAX function was set to ON.

If the measured voltage value has exceeded the measuring range limit at least once with the MINMAX function set to ON, "+OL" appears at the display for UMAX and "+999999." is entered to the data string.

The Min-Max memory value can be reset to the momentarily measured value with **MINMAX RST** (for all 4 parameters at once).

Query Command

Syntax: **UMAX?**
Sample response string: **UMAX +XXX.XXX**

UMIN? – Minimum Measured Voltage Value

 Menu

Function

The UMIN function reads out the lowest output voltage value which was measured by the Uout measuring function and saved to Min-Max memory while the MINMAX function was set to ON.

If the measured voltage value has fallen below the measuring range limit at least once with the MINMAX function set to ON, "-OL" appears at the display for UMAX and "-999999." is entered to the data string.

The Min-Max memory value can be reset to the momentarily measured value with **MINMAX RST** (for all 4 parameters at once).

Query Command

Syntax: **UMIN?**
Sample response string: **UMIN +XXX.XXX**

UOUT? – Querying the Momentary Voltage Value

 SELECT A

Function

The UOUT? function reads out the momentary measured value for output voltage.

Type	Voltage Measuring Range		Resolution
	Min. [V]	Max. [V]	
Nominal voltage			
60 W	-016.384	+098.300 A	2 mV

The upper range values may change minimally after balancing!

If the measuring range is exceeded or fallen short of, "+/-OL" is displayed or "+/-999999" is entered to the data string.

Query Command

Syntax: **UOUT?**
Sample response string: **UOUT +XXX.XXX**

USET, USET? – Voltage Setpoint Value

 SELECT A and Rotary Encoder Uset

Function

The output voltage setpoint is set with USET. The USET? query returns the currently selected voltage setpoint as a response.

Values outside of the value range ($0 \leq UL_L \leq w \leq UL_H \leq Unom$) are not accepted, and cause generation of an error message and setting of an error bit in event register ERC.2.

Entered numeric values are rounded off to device-specific resolution.

Setting Command

Syntax: **USET w**
Value range: $0 \leq UL_L \leq w \leq UL_H \leq Unom$
Default setting
or after RESET (*RST): $w = 0$

Query Command

Syntax: **USET?**
Sample response string: **USET +XXX.XXX**

Device Type	Setting Range		Setting Resolution		
	Nom. Voltage [V]	Min. [V]	Max. [V]	Remote [V]	Manual [V]
	60	0.000	60.000	0.001	0.001

WAIT – Additional Waiting Time

 —

Function

Command for specifying an additional waiting time between execution of the two commands. This function can be used to add additional waiting time within a data string (linked commands) during processing/execution.

For example, this allows for defined programming of a specified power-on status within a command string with execution time in the ms range.

Setting Command

Syntax: **WAIT w**
Value range: $0.001 \text{ s} \leq w \leq 65.535 \text{ s}$

Caution

During the execution of waiting time receive data are not processed and the input buffer is blocked, i.e. displays are not refreshed during waiting time.

Example

ISSET 5; OUTPUT ON; USET 10; WAIT 0.100; USET 5

Meaning of Register Contents

Register Name	Meaning
ACLC	AC-LEVEL CHANGED (line voltage range has changed H → L, L → H)
ACLL	AC level Low (line voltage < 182 V _{rms})
CCE	Measured current values are outside of the tolerance band specified by UI_C_SET w1.w2.w3.w4 divided by w3.w4; ENABLE: "MINMAX ON"
CCR	Output is (was) in current regulating mode.
CVR	Output is (was) in voltage regulating mode.
CME	Unknown error, syntax error, standardized value limits for numeric parameters have been exceeded.
CMPC	Compare current: current value not within current tolerance band specified by UI_C_SET w1.w2.w3.w4 divided by w3.w4; ENABLE: "MINMAX ON"
CMPV	Compare voltage: voltage value not within voltage tolerance band specified by UI_C_SET w1.w2.w3.w4 divided by w1.w2; ENABLE: "MINMAX ON"
CVE	Measured voltage values outside of tolerance band specified by UI_C_SET w1.w2.w3.w4 divided by w1.w2; ENABLE: "MINMAX ON"
DDE	Internal device error is pending
EXE	Command-specific parameter limits exceeded, incompatibility of a command or a parameter with a current operating state.
LIME	Limit error: Error message after setting command for USET, ISET, UL_L, UL_H, IL_L, IL_H: a) Setting range UL_L ≤ USET ≤ UL_H or IL_L ≤ ISET ≤ IL_H exceeded; or b) Measuring range exceeded during voltage or current measurement c) Limit errors may also occur during a sequence. Note regarding examination of limit and setting values.
MAV	Finished message after query command: The requested information is ready for pick-up at the data output buffer.
OCPA	Output deactivated by overcurrent protection (OCP function). Switch back on with OUTPUT ON.
CP	Overload message: Power limiting has been triggered.
OPC	Finished message: The commands preceding the *OPC command have been processed (synchronization).
OTP1A	Overtemperature warning: The device is overheated, e.g. due to inadequate ventilation. If overheating is further increased, the output is switched off when the OTP2A threshold is reached. The OTP2A shutdown threshold is approximately 5° C higher than the OTP1A warning threshold.
OTP2A	Overtemperature message and shutdown: The device is overheated, e.g. due to inadequate ventilation. The output is deactivated when this message is generated. The OUTPUT ON setting command is ignored as long as this condition persists, and causes setting of the OTP2A bit in the event register.
OTP2I	Ready message after OTP2A overtemperature message: The device has cooled back down. If the POWER-ON function is set to standby or reset, the output remains deactivated; if set to recall, automatic restart ensues.
OUTE	Output error: Error message, power output can not be activated. Activation of the output is disabled by an internal hardware status, or is locked by means of the OUTPUT OFF signal at the trigger input of the analog interface. Display: "Err 73"
OVPA	Overvoltage protection has been triggered, the output has been deactivated. Switch back on with OUTPUT ON.
PON	Device was intermittently switched off, or an intermittent mains failure has occurred.
QYE	Error message after addressing as talker: A message is not (yet) ready for pick-up at the output buffer.
REMC	Status change: REMOTE → LOCAL (manual operation ensues)
S1A	SIG 1, active signal has occurred
S2A	SIG 2, active signal has occurred
S3A	SIG 3, active signal has occurred
S123A	Signal output SIG 1 or/and SIG 2 or/and SIG 3 at the analog input is active
SEQB	Status message: The sequence function is active (run, halt).
SEI	Finished message: The sequence function is finished or has been aborted (inactive) (ready).
SEQE	Error message resulting from the sequence function.
T1A	A signal has occurred at trigger input TRG 1 of the analog interface with a setting of: trigger mode ≠ OFF
T2A	A signal has occurred at trigger input TRG 2 of the analog interface with a setting of: trigger mode ≠ OFF
TCB	TST or ADJUSTCAL function active
TCE	Self-test error or error during ADJUST has occurred

Description of the Registers

Condition Registers (CRA, CRB)

The individual bits in the conditions registers reflect the current status of a specific device function:
0 = status does not apply (FALSE)
1 = status applies (TRUE)
The content of the condition register can be read out with the help of a query command, but cannot be directly edited or cleared.

Event Registers – Standard Event Register (ESR), Event Registers (ERA, ERB, ERC)

The event registers acquire and save changes to specific device functions. The corresponding bit in the event register is set (1 = TRUE) if the associated function:
– Changes from FALSE to TRUE (with input ⌋) or
– Changes from TRUE to FALSE (with input ⌋).
The four event registers can be queried individually. The content of an event register is cleared when it is queried. An enable register is assigned to each event register.

Enable Registers – Standard Event Enable Register (ESE), Event Enable Registers (ERAE, ERBE, ERCE), Service Request Enable Register (SRE), Parallel Poll Enable Register (PRE)

The enable registers determine which bit(s) from the associated register or status byte register is (are) capable of influencing the respective group message (masking). The respective group message remains set (1 = TRUE), as long as at least one bit enabled to this end has a status of TRUE.
The six enable registers can be written to and queried separately. The content of the registers is not changed by queries. Enable registers ERAE, ERBE and ERCE are set to zero when the device is switched off. Enable registers ESE, SRE and PRE are only cleared as a result of shutdown if the PSC bit is set to 1.

Status Byte Register (STB)

The status byte register contains:
– The statuses of the group messages from the three event registers with bits 1, 2, 3 and 5
– The status of the data output buffer with bit 4 (empty → MAV = 0, not empty → MAV = 1)
– The status of group message MSS consisting of bits 1, 2, 3, 4 and 5, masked by enable register SRE, with bit 6
– Bits 0 and 7 are not used and are always set to "0".

Register contents can be read out:

- With the ***STB?** query command or
- In the case of IEC bus control, with the "Serial Poll" interface command. In this case, bit 6 shows the RQS status, which is reset (0) after serial polling has been completed.

The ***CLS** setting command clears all of the event registers and the status byte register, with the exception of the MAV bit, and cancels any pending SRQ message.

Power-On Status Clear Bit Error

The power-on status clear bit determines whether or not the content of enable registers ESE, SRE and PRE will be cleared when the device is switched off.

The PSC bit can be set and queried:

Set: ***PSC** *n n = 0*: ESE, SRE and PRE are not cleared
n = 1: ESE, SRE and PRE are cleared

Query: ***PSC?** Response: "0" or "1"

The PSC bit setting also remains unchanged after the device is switched off, or after the ***CLS** command has been executed.

Operation Complete Bit (OPC)

See *OPC and *OPC? commands for a description of the respective function.

10 Table of Operating and Query Commands

10.1 Adjustable Functions and Parameters

Setting Command	Parameter	Meaning	Value Range / Selection	Default Setting After RESET *RST	Manual	Remote
Display and Interface Settings ¹⁾ (see chapter 6, main menu level SETUP DISPLAY & INTERFACE)						
Addr	n	Set device address for IEEE 488 (interface configuration)	$0 \leq n \leq 30$	unv	X	
bAUd	txt	RS 232 transmission speed	Set via menu selection, default setting: 9600 baud. The following values can be selected manually: 1200, 1800, 2400, 3600, 4800, 7200, 9600, 14,400, 19,200, 28,800, 38,400, 57,600 or 115,200 [baud]	unv	X	
DB		RS 232 data bits	7 or 8, set via selection menu, default setting: 8	unv	X	
PB		RS 232 parity bit	Set via menu selection, default setting: none The following values can be selected manually: nonE, EVEn or odd	unv	X	
SB		RS 232 stop bit	1 or 2, Default setting: 1	unv	X	
bAUd	txt	USB transmission speed (DB = 8, PB = no, SB = 1)	Set via menu selection, default setting: 115,200 baud. The following values can be selected manually: 9600, 14,400, 19,200, 28,800, 38,400, 57,600 or 115200 [baud]	unv	X	
DDC	n	Display switching time	Set via menu selection, default setting: 10 s. The following values can be selected manually: 5, 10, 15, 20, 30, 45, 90 or 180 [s]	unv	X	
General Commands and Settings						
*CLS		Clear Status		—	X	
*DDT	txt	Define Device Trigger	txt Command string with up to 80 characters, delimiter for commands is slash (/) instead of semicolon (;)	—	X	
*ESE	n	Standard Event Status Enable	$0 \leq n \leq 255$, n = decimal equivalent of register content	—	X	
*OPC		Operation Complete		—	X	
*PRE	n	Parallel Poll Enable Register Enable	$0 \leq n \leq 255$, n = decimal equivalent of register content	—	X	
*PSC	n	Power-On Status Clear	n = 0, 1	—	X	
RCL	n	Recall a device setting stored to a setup memory location (1 through 12/15)	$1 \leq n \leq 12/15^$; Special case n = 99 means undo after *RST, *RCL #	—	X	X
*RST		Reset device to default values		Default	X	X
SAV	n	Save current device settings to a setup memory location (1 through 12/15)	$1 \leq n \leq 12/15^$	—	X	X
*SRE	n	Service Request Enable	$0 \leq n \leq 255$, n = decimal equivalent of register content	—	X	
*TRG		Trigger for executing *DDT functions		—	X	
*WAI		Wait to continue		—	X	
DCL / SDC		Device clear function		—	X	
ERAE	n	Device Dependent Event Register A Enable	$0 \leq n \leq 255$, n = decimal equivalent of register content	—	X	
ERBE	n	Device Dependent Event Register B Enable	$0 \leq n \leq 255$, n = decimal equivalent of register content	—	X	
ERCE	n	Device Dependent Event Register C Enable	$0 \leq n \leq 255$, n = decimal equivalent of register content	—	X	

* /15 or /1700, respectively as from firmware version 004

Setting Command	Parameter	Meaning	Value Range / Selection	Default Setting After RESET *RST	Manual	Remote
Devise-Specific Settings						
ADJUST (CAL)	txt,(w)	Balancing/calibration function	UOFF / UFS / IOFF / IFS / (EXIT), $0 \leq w \leq$ respective balancing limit. The specified order for the procedure must be adhered to! "EXIT" → UNCAL, abort with error message	—	X	X
ANALOG_IN	txt1,txt2	Connection of analog control inputs U(Uext), U(Iext)	OFF / ON / SSET	OFF	X	X
C_DYN	txt	Setting for current regulating dynamics	R / L	R	X	X
DISPLAY	txt1,txt2	Digital display function switching	txt1: ON / OFF / UO / US / PS txt2: ON / OFF / IO / IS / PO	UO IO	X	X
FSET	txt	Sequence function parameter	CLR / NF / RU / RI / SOFF / S_ON / AUOF / AUON / AUSS / AIOF / AION / AISS / R01 ... R12/15* / S01 ... S12/15*	CLR	X	X
IL_H (ILIM)	w	Upper limit value for current setting	$I_{set} \leq w \leq I_{nom}$ [A]	I_{nom}	X	X
IL_L	w	Lower limit value for current setting	$0 \leq w \leq I_{set}$ [A]	0	X	X
ISET	w	Current setpoint [A]	$IL_L \leq w \leq IL_H$ [A]	0	X	X
MEAS_LPF	txt	Low-pass filter for measured value acquisition	1 / 2 / 3 / 4	3	X	X
MINMAX	txt	Min-max storage for measured U and I values	OFF / ON / RST "ON" → enable tolerance band function for CRB.0/1, ERC.0/1, SIGx_OUT	OFF	X	X
OC_DELAY	w	Overcurrent protection triggering delay	$0.000 \leq w \leq 65.535$ [s]	0	X	X
OCp	txt	Overcurrent protection	OFF / ON / R01 ... R12/15*	OFF	X	X
OCSET	w	Overcurrent protection trigger value	$OCSET_{min} (3) [A] \leq w \leq OCSET_{max} (80 A) [A]$	80 A	X	X
OUTPUT	txt	Switch power output on and off	OFF/ ON	OFF	X	X
OV_DELAY	w	Overvoltage protection triggering delay	$0.000 \leq w \leq 65.535$ [s]	0	X	X
OVP	txt	Overvoltage protection	OFF / ON / R01 ... R12/15*	ON	X	X
OVSET	w	Overvoltage protection trigger value	$3 [V] \leq w \leq OVSET_{max} (80 V) [V]$	80 V	X	X
POWER_ON	txt	Response after power on	RST / SBY / RCL / R01 ... R12/15*	RST	X	X
PSET	w	Power setpoint [W]	$0 \leq w \leq P_{nom} (1500, 3000, 4500) [W]$ (PSET = PNOM) → P-REG. OFF)	P_{nom}	X	X
REPETITION	n,(i)	Number of repetitions for sequence function	$0 \leq n \leq 255$; 0 means continuous repetition. i is an optional parameter for the setup memory location (1 through 12/15), which should be written directly with REPETITION.	0	X	X
SEQUENCE	txt,(n)	SEQUENCE control command	OFF / GO / HOLD / CONT,(n) / STRT / STEP ,(n) / BSTP / STOP / ESC n is an optional parameter from start address to stop address	—	X	X
SIG123	txt1,txt2,txt3	Analog interface signal outputs	OFF / ON / OUT / MODE / SEQ / SSET / U_LO / U_HI / I_LO / I_HI	OFF	X	X
SINK	txt	Sink function on/off	OFF / ON	ON	X	X
SM_LOAD	n	Load sequence memory location USET,ISET,TSET,FSET	$1 \leq n \leq 1536/1700^*$	—	X	X
SM_STORE	n	Write current USET,ISET,TSET,FSET to sequence memory location	$1 \leq n \leq 1536/1700^*$ n = 0: clear contents from start to stop address	—	X	X
SSET	txt	Command for an assigned switching function	OFF / ON	OFF	X	X
START_STOP	m,n,(i)	Start and stop address	$1 \leq n1 \leq n2 \leq 1536/1700^*$ i is an optional parameter for the setup memory location (1 through 12/15), which should be written directly with START_STOP.	1.1	X	X
STORE	n,w1,w2,w3,txt	Transfer parameters directly to memory	$1 \leq n \leq 1536/1700^*$, memory location address $0 \leq w1 \leq U_{nom}$ [V] $0 \leq w2 \leq I_{nom}$ [V] $0 \leq w3 \leq 65.535$ [s], 0 means Tdef txt, see "FSET"	—	X	X
T_MODE	txt1,txt2	Function selection for trigger inputs	OFF / OUT / SQS / SEQ,(n) / LLO / MIN ,(n) / AIX / AIU / All	OFF	X	X
TDEF	w,(i)	Default time rate for SEQUENCE function	$0.001 \leq w \leq 65.535$ [s] i is an optional parameter for the setup memory location (1 through 12/15*), which should be written directly with TDEF.	0.001	X	X
TIMEDATE	txt	Set system clock (RTC)	yyyy-mm-ddThh:mm:ss	urvv	X	X
TSET	w	Memory location-specific dwell time for sequence function	$0.000 = T_{def}$, $0.001 \leq w \leq 65.535$ [s]	0.000	X	X
UI_C_SET	w1,w2,w3,w4	Reference values for Uout/Iout, tolerance band function	w1, w2: $0 \leq w1 < w2 \leq U_{nom}$ [V] w3, w4: $0 \leq w3 < w4 \leq I_{nom}$ [A]	0, U_{nom} , 0, I_{nom}	X	X
UL_H (ULIM)	w	Upper limit value for voltage setting	$U_{set} \leq w \leq U_{nom}$ [V]	U_{nom}	X	X
UL_L	w	Lower limit value for voltage setting	$0 \leq w \leq U_{set}$ [V]	0	X	X
USET	w	Voltage setpoint [V]	$UL_L \leq w \leq UL_H$ [V]	0	X	X
WAIT	w	Additional waiting time	$0.001 \leq w \leq 65.535$ [s]	—	X	

Abbreviating commands: Abbreviated commands are identified with boldface letters. Letters not printed in boldface can be omitted. Example: "OUTPUT ON" = "OU ON"

As a rule, letters can be entered in upper or lower case.

Stringing commands together: Several commands is a single data string must be separated by semicolons (;). Example: "USET 12; ISET 8.5; OUTPUT ON"

Formats for numeric parameters: m, n: Whole number (integer);

w: Whole number, fixed or floating decimal point number with or without exponent. Examples: "12.5", "0012.5", "1.25E1", "+1.25 e+01"

* /15 or /1700, respectively as from firmware version 004

10.2 Queriable Functions and Parameters

Query Command	Meaning	Response Parameter	Values / Format	Manual	Remote	Sample Response	Response String Length
General Query Commands							
*DDT?	Define device trigger	txt	Delimiter for commands: “;”		X	USET 5.123;ISET 10:OUTPUT ON	≤ 80
*ESE?	Standard event status enable query	n	0 ≤ n ≤ 255		X	127	3
*ESR?	Standard event status register query	n	0 ≤ n ≤ 255		X	0	1
*IDN?	Query device ID	txt			X	GMC-I GOSSEN-METRAWATT, PSP1500 P060RU060P,0-Series No 008 ,01. B01	63
*IST?	Individual status query	n	n = 0, 1		X	0	1
*LRN? (i)	Query device settings (LEARN) i is an optional parameter for the setup memory (location 1 through 12/15), which should be read out directly.	txt			X		
	Sample response for *LRN?					<pre> 0 10 20 30 O U T P U T O F F ; U S E T + 0 1 0 . 0 0 0 ; I S E T 1 + 0 1 0 . 0 0 0 ; P S E T + 0 1 5 0 0 . 0 ; U L _ L + 0 2 0 0 . 0 0 0 ; U L _ H + 0 6 0 . 0 0 0 ; I L _ L + 0 0 0 3 . 0 0 0 ; I L _ H + 0 6 0 . 0 0 0 ; O V P O N ; O V S 4 E T + 0 8 0 . 0 0 0 ; O V _ D E L A Y 0 0 . 0 0 0 ; O C 5 P O F F ; O C S E T + 0 8 0 . 0 0 0 ; O C _ D E L A Y 6 0 0 . 0 0 0 ; P O W E R _ O N R S T ; T _ M O D E O F F 7 , O F F ; A N A L O G _ I N O F F , O F F ; S I N K 8 O N ; C _ D Y N R ; M E A S _ L P F 3 ; M I N M A X 9 O F F ; S I G 1 2 3 O F F , O F F , O F F ; S S E T 10 O F F ; F S E T N F ; T D E F 0 1 . 0 0 0 ; T S E 11 T 0 0 . 0 0 0 ; S T A R T _ S T O P 0 0 0 1 , 0 0 0 5 ; 12 R E P E T I T I O N 0 0 0 ; D I S P L A Y U O , I O 13 </pre>	390
*OPC?	Operation complete query	n	n = 0, 1		X	1	1
*PRE?	PPOLL enable register enable query	n	0 ≤ n ≤ 255		X	40	2
*PSC?	Power-on status clear query	n	n = 0, 1		X	0	≤ 3
*SRE?	Service request enable query	n	0 ≤ n ≤ 255		X	32	≤ 3
*STB?	Read status byte query	n	0 ≤ n ≤ 127		X	16	≤ 3
*TST?	Self-test function	n	n = 0, 1		X	0	1
CRA?	Condition register A	n	0 ≤ n ≤ 255	X	X	1	≤ 3
CRB?	Condition register B	n	0 ≤ n ≤ 255	X	X	0	≤ 3
ERA?	Device dependent event register A query	n	0 ≤ n ≤ 255	X	X	1	≤ 3
ERAE?	Device dependent event register A enable query	n	0 ≤ n ≤ 255		X	240	≤ 3
ERB?	Device dependent event register B query	n	0 ≤ n ≤ 255	X	X	0	≤ 3
ERBE?	Device dependent event register B enable query	n	0 ≤ n ≤ 255		X	128	≤ 3
ERC?	Device dependent event register C query	n	0 ≤ n ≤ 255	X	X	64	≤ 3
ERCE?	Device dependent event register C enable Query	n	0 ≤ n ≤ 255		X	0	≤ 3
Device-Specific Functions and Queries							
ANALOG_IN?	Connection of analog control inputs U(Jext), U(text)	txt1,txt2	OFF / ON / SSET	xx	X	ANALOG_IN ON, OFF	19
C_DYN?	Setting for current regulating dynamics	txt	R / L	X	X	C_DYN R	7
DISPLAY?	Digital display function switching	txt1,txt2	txt1: ON / OFF / UO / US / PS txt2: ON / OFF / IO / IS / PO	xx	X	DISPLAY UO, PO	15
ERROR?	List of error messages	n1,n2,n3,n4	n1,n2,n3: last error n4: µC-RSTSRC register	X	X	ERROR 032,031,000.001	21
FSET?	Sequence function parameter	txt	CLR / NF / RU / RI / SOFF / S_ON / AUOF / AUON / AUSS / AIOF / AION / AISS / R01 ... R12/15* / S01 ... S12/15*	X	X	FSET NF	9
IL_H? (ILIM?)	Upper limit value for current setting	w	+XXX.XXX [A]	X	X	IL_H +060.000	13
IL_L?	Lower limit value for current setting	w	+XXX.XXX [A]	X	X	IL_L +000.000	13
IMAX?	Max. measured current value	w	+XXX.XXX [A]	X	X	IMAX +000.212	13
IMIN?	Min. measured current value	w	+XXX.XXX [A]	X	X	IMIN +000.204	13
IOUT?	Presently measured current value	w	+XXX.XXX [A]	X	X	IOUT +000.208	13
ISET?	Selected current setpoint	w	+XXX.XXX [A]	X	X	ISET +015.000	13
MEAS_LPF?	Low-pass filter for meas. value acquisition	txt	1 / 2 / 3 / 4	X	X	MEAS_LPF 3	10

¹⁾ manual: last error only; xx: manual: division into partial functions

Query Command	Meaning	Response Parameter	Values / Format	Manual	Remote	Sample Response	Response String Length
MINMAX?	Min-Max storage for measured U and I values	txt	OFF / ON "ON" → enable tolerance band function for CRB.0/1, ERC.0/1, SIGx_OUT	X	X	MINMAX OFF	10
MODE?	Momentary control mode of the power output	txt	CV / CC / CP / OL / OFF	LED	X	MODE CV	8
OC_DELAY?	Overcurrent protection triggering delay	w	$0.000 \leq w \leq 65.535$ [s]	X	X	OC_DELAY 00.000	15
OCP?	Overcurrent protection	txt	OFF / ON / R01 ... R12/15*	X	X	OCP OFF	7
OCSET?	Overcurrent protection trigger value	w	+XXX.XXX [A]	X	X	OCSET +080.000	15
OUTPUT?	Output on-off status	txt	OFF/ ON	LED	X	OUTPUT ON	10
OV_DELAY?	Overvoltage protection triggering delay	w	XX.XXX [s] $0 \leq w \leq 65,535$ [s]	X	X	OV_DELAY 00.000	15
OVP?	Overvoltage protection	txt	OFF / ON / R01 ... R12/15*	X	X	OVP ON	7
OVSET?	Overvoltage protection trigger value	w	+XXX.XXX [V]	X	X	OVSET +080.000	15
POUT?	Current output power	w	+XXXXX.X [W]	X	X	POUT +00002.1	14
POWER_ON?	Response after power on	txt	RST / SBY / RCL / R01 ... R12/15*	X	X	POWER_ON SBY	12
PSET?	Power setpoint [W]	w	+XXXXX.X [W] $W = P_{nom}$ ($P_{nom}/2$ for 115 Vac) ¹⁾ $W \leq P_{nom}$ ($P_{set} < P_{nom}/2$ for 115 Vac) ²⁾	X	X	PSET +01500.0	13
REPETITION? (i)	Number of repetitions for sequence function i is an optional parameter for the setup memory location (1 through 12/15*), which should be read out directly.	n	$0 \leq n \leq 255$; 0 means continuous repetition	X	X	REPETITION 000	15
RLOAD?	Momentary load resistance [Calculated value $R = U/I$]	w	+XXX.XXX [Ω]	X	X	RLOAD +030.833	14
SEQUENCE?	SEQUENCE Status	txt,n1,n2,n3	txt: RDY / HALT / RUN n1: $000 \leq n1 \leq 012/15^*$ (setup memory) n2: $001 \leq n2 \leq 255$ (remaining repetitions), n2 = 999 = continuous n3: $0001 \leq n3 \leq 1536/1700^*$ (memory location)	xx	X	SEQUENCE RDY,000.999,0005	26
SIG123?	Analog interface signal outputs	txt1,txt2,txt3	OFF / ON / OUT / MODE / SEQ / SSET / U_LO / U_HI / I_LO / I_HI	X	X	SIG123 MODE, OUT, OFF	21
SINK?	Sink function on/off	txt	OFF / ON	X	X	SINK ON	8
SSET?	Status of an assigned switching function	txt	OFF / ON	X	X	SSET OFF	8
START_STOP? (i)	Start and stop address i is an optional parameter for the setup memory location (1 through 12/15), which should be read out directly.	m,n	$1 \leq n1 \leq n2 \leq 1536/1700^*$	xx	X	START_STOP 0001.0005	20
STORE? (m,(n,(tab)))	Read data from sequence memory See "Descriptions of Operating Commands" for further details.	n,w1,w2,w3,txt	n: memory location address w1: +XXX.XXX [V] w2: +XXX.XXX [A] w3: XX.XXX [s] txt: "FSET"	xx	X	STORE 0003,+020.000,+015.000,00.000, NF	40
T_MODE?	Function status for trigger inputs 1 and 2	txt1,txt2	OFF / OUT / SQS / SEQ,(n) / LLO / MIN ,(n) / AIX / AIU / AII	X	X	T_MODE OUT, LLO	15
TDEF? (i)	Default time for sequence function i is an optional parameter for setup memory (1 through 12/15), which should be read out directly.	w	$0.001 \leq w \leq 65.535$ [s]	X	X	TDEF 01.000	12
TIMEDATE?	System clock time/date (RTC)	txt	yyyy-mm-ddThh:mm:ss	xx	X	TIMEDATE 2007-10-08T12:27:13	28
TSET?	Memory location-specific dwell time for sequence function	w	$0.000 \leq w \leq 65.535$ [s] $0.000 = T_{def}$,	X	X	TSET 00.000	12
UI_C_SET?	Reference values for Uout/Iout, tolerance band function	w1,w2,w3,w4	w1, w2: $0 \leq w1 < w2 \leq U_{nom}$ [V] w3, w4: $0 \leq w3 < w4 \leq I_{nom}$ [A]	xx	X	UI_C_SET +000.000,+060.000,+000.000,+060.000	44
UL_H? (ULIM?)	Upper limit value for voltage setting	w	+XXX.XXX [V]	X	X	UL_H +060.000	13
UL_L?	Lower limit value for voltage setting	w	+XXX.XXX [V]	X	X	UL_L +000.000	13
UMAX?	Max. measured voltage value	w	+XXX.XXX [V]	X	X	UMAX +010.004	13
UMIN?	Minimum measured voltage value	w	+XXX.XXX [V]	X	X	UMIN +009.992	13
UOUT?	Presently measured voltage value	w	+XXX.XXX [V]	X	X	UOUT +009.998	13
USET?	Selected voltage setpoint	w	+XXX.XXX [V]	X	X	USET +010.000	13

Terminating device messages: The following end-of-text characters can be used for data receipt:

With IEC bus control: NL (hex: 0A) or NL & EO1 or DAB & EO1;
With RS 232C control: NL or CR (hex: 0D) or ETB (hex: 17) or ETX (hex: 03).

The following end-of-message character is used when transmitting the response string:With IEC bus control: NL & EO1;

With RS 232C control: last received end-of-message character.

Abbreviating commands: Abbreviated commands are identified with boldface letters. Letters not printed in boldface can be omitted. Example: "OUTPUT ?" = "OU?"

As a rule, letters can be entered in upper or lower case.

Stringing commands together: Several commands in a single data string must be separated by semicolons (;). Example: "USET?; ISET?; OUTPUT?"

¹⁾ Constant voltage and/or constant current mode

²⁾ Constant power mode

* /15 or /1700, respectively as from firmware version 004

xx: manual: division into partial functions

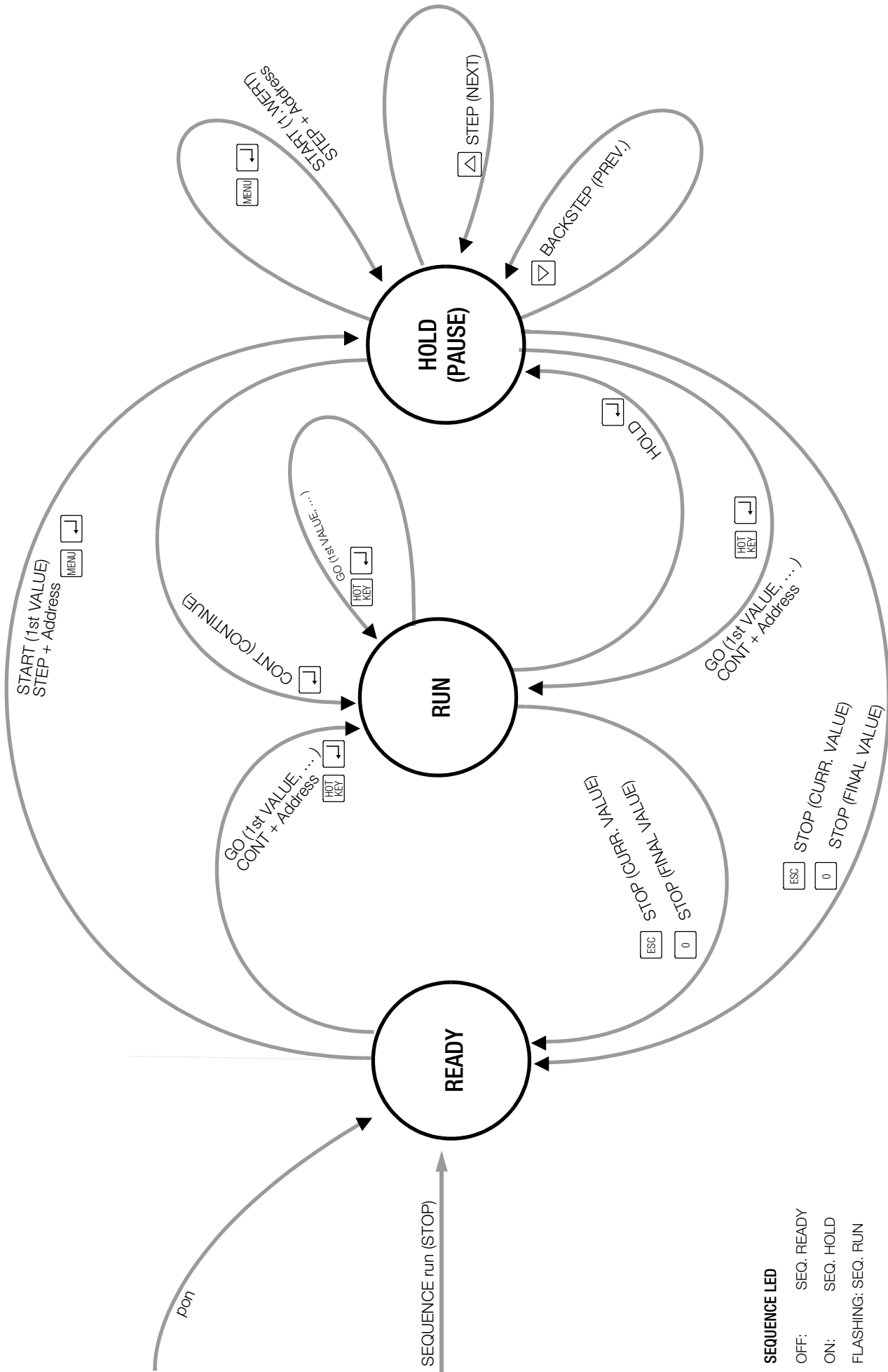

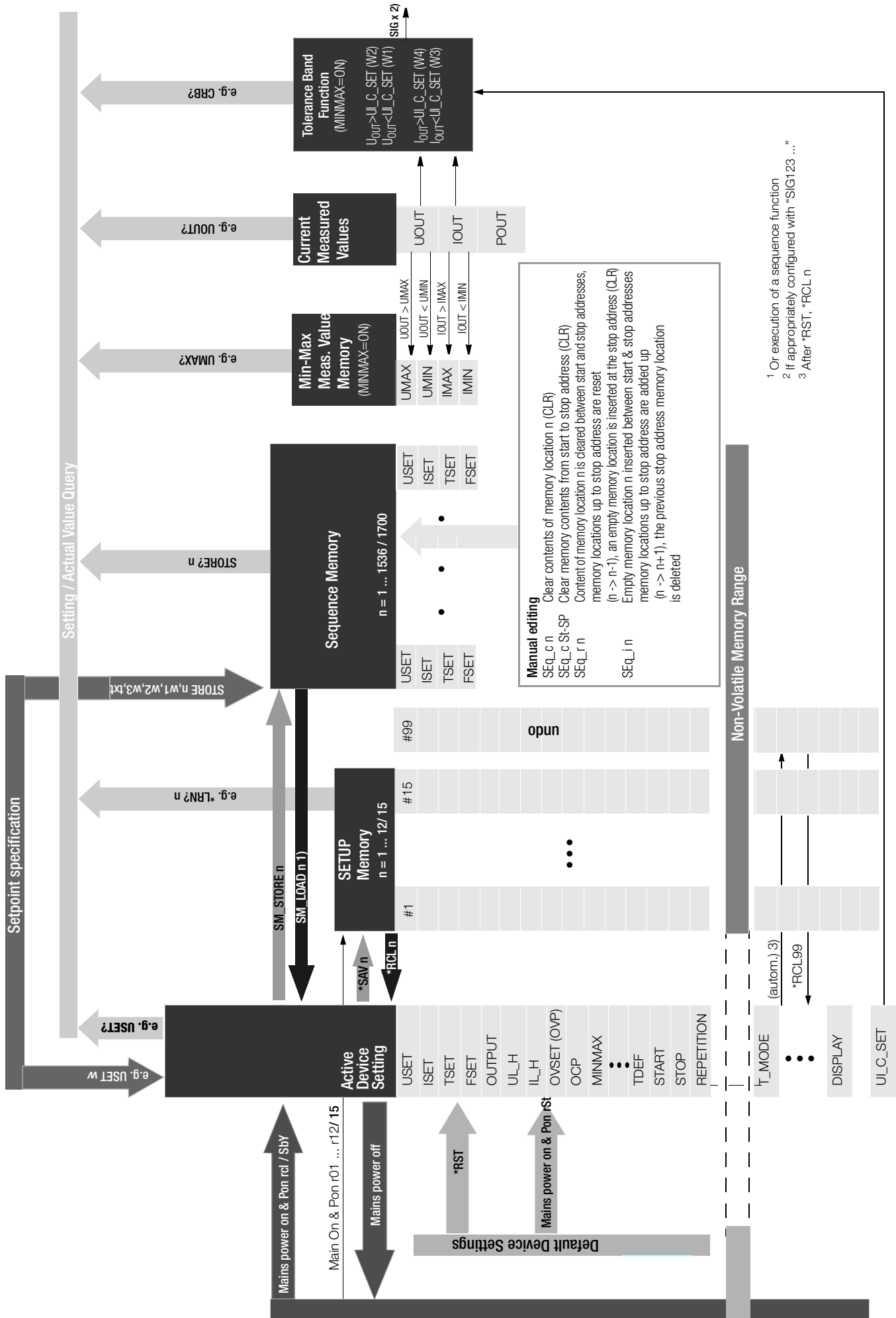

1 Or execution of a sequence function
 2 If appropriately configured with "SIG123 ..."
 3 After *RST, *RCL n

11 System Messages

Procedures and entries are monitored in order to provide the user with support.

The device is capable of detecting and reading out a great variety of defective procedures.

In the case of manual operation, the error appears directly at the display for a brief period of time. In addition to this, the last error message can be viewed with the help of the appropriate menu function.

Err appears at the left-hand display, and the three digit error code at the right-hand display.

In the case of operation with a PC, the last three error messages can be accessed by executing the **ERROR?** command (see **ERROR?** command in the section entitled "Descriptions of Operating Commands").

Code Err...	Meaning / Cause	Remedy
00	No error	
01	TYPE (BZ) detection	For internal production process only
05	UNKNOWN KEYCODE, or in case of "LCL LOCKED", [ESC] has been briefly activated for enabling	
12	CMD buffer overflow	Overflow at internal CMD buffer
21	USET, ISET, PSET (parameter error)	
22	UL,IL (parameter error)	
29	DDTE *DDT command string > 80 characters or ?*TRG? within *DDT ...	
31	CME command error	General
32	EXE execution error	General
	Interface	
51	RS 232, PB, parity bit	
52	RS 232, SB, stop bit	
53	PB + SB, RS 232	
54	RS232, FRAME OVERFLOW (impermissible combination DB/PB/SB)	Only occurs during manual configuration
55	Active talker state but no listener present	Only possible with IEEE 488 interface option
56	IEC\$LATA\$ERR (active listener and active talker)	Only possible with IEEE 488 interface option
61	ADJUST parameter error	
62	ADJUST order impermissible (REMOTE)	
63	[U/I]-OFFSET/FULL SCALE -> (!) [CV/CC] MODE	Corresponding operating mode required!
64	ADJUST LIMITs or OFFSET (MEASUREMENT NEGATIVE or OVERFLOW)	
66	CALIBRATION ERROR/EXIT (-> UNCAL)	
69	MEMORY DATA (-> ERROR) ?	Faulty data, possible cause: low battery
71	Table values (#): USET<UL_L, USET>UL_H, ISET<IL_L, ISET>IL_H	Limit error during sequence execution
73	OUTE: "OUTPUT ON" =/= Tx MODE "OUT" & Tx-SIG "OUT OFF"	Trigger mode power output and signal blocked (=OFF!)
74	TRGE: "MINMAX ON" =/= Tx MODE "MIN" & Tx-SIG "MINMAX OFF"	Min-max control for the trigger mode and signal blocked (=OFF!)
75	TRGE: "SEQUENCE ON" =/= Tx MODE "SEQ" & Tx-SIG "SEQUENCE STOP"	Sequence control for the trigger mode and signal blocked (=OFF!)
76	TRGE: "ANALOG INP" =/= Tx MODE "AI?" & Tx-SIG (UEXT,IEXT)	Uext, Iext control for the trigger mode and signal blocked (=ON!)
81	RCL n (no data): SETUP memory n: invalid or no data	
82	START -> STOP - INVALID VALUES	
83	START-ADR > STOP-ADR	
84	Not (STOP_ADR < MEM < START_ADR) or SUBSEQUENCE (cond.)	Address range or storage address is out of actual start-stop-address range or is an active sub-sequence. Specify the sequence range for delete and repeat command.
85	CONTINUE (no initialization, status =/= "HALT")	
86	SUBSUBSEQUENCE impermissible	
89	"SEQUENCE OFF" required for current command	
91	SELFTEST (*TST?)	
96	MIN LIMIT UNDERFLOW, direct entry of a numerical value	requires > UL_L and/or > IL_L
93	Current command not permissible for power control!	Impermissible combination of functions
96	MIN LIMIT UNDERFLOW	Numerical direct entry of a numerical value > UL_L and/or > IL_L necessary
97	MIN LIMIT UNDERFLOW	
98	MAX LIMIT OVERFLOW	
99	OVERLOAD / OVERFLOW	

DISPLAY		Meaning/Cause	Remedy
left	right		
Err	PFC	PFC Error	Inadequate/unstable line voltage or device error, not ready for operation, device controls disabled, shutdown (OUTPUT OFF)
Err	AC-H	Change from AC-LOW to AC-HIGH	Transition from the „lower“ line voltage range (= status after power ON) AC_L to the „upper“ range AC_H generates message „ERR AC-H“. Please note: Pnom value is not automatically raised in the process! A new „Power ON“ is required for this purpose, including: – automatic RESET (parameter setting: „POWER_ON RST“) or – subsequent „RESET“ (manual operation/interface) or – Recall of a suitable SETUP memory (which has not been saved under power derating conditions!) (Pnom is the reference quantity for the PSET function!)
Err	AC-L	Change from AC-HIGH to AC-LOW	up to and including firmware 004: Transition from the „upper“ line voltage range to the „lower“ range generates message „ERR AC-L“ and results in a shutdown if no power derating has been active (operation disabled, „Power ON“ required!) Transition from the „upper“ line voltage range AC_H to the „lower“ range AC_L generates message „ERR AC-L“ without shutdown if power derating has already been active. as from firmware 005: Transition from the „upper“ line voltage range to the „lower“ range generates the message „ERR AC-L“ and results in power derating, as long as the status „AC LOW“ „lower“ line voltage range applies. Upon reversal of the line voltage to the „upper“ line voltage range (status „AC HIGH“), the power derating is cancelled.
Err	AC-F	AC-FAIL	Inadequate/unstable line voltage or device error, not ready for operation, device controls disabled, shutdown (OUTPUT OFF) as from firmware 010: Temporary deactivation for the purpose of device protection. If insufficient/instable line voltage is present or a device error occurs, the instrument shuts down (OUTPUT OFF) and is not ready for operation during this time. After approximately 0.25 s, an automatic restart is performed by the instrument in accordance with the settings for POWER_ON (standby, reset, recall).

RSTSRC (RESET SOURCE REGISTER):

Description / Text per Data Sheet no. C8051F122

D7	(80H): RESERVED
D6	(40H): CNVRSEF: (CONVERT START 0 RESET SOURCE FLAG)
D5	(20H): CORSEF: (COMPARATOR 0 RESET FLAG)
D4	(10H): SWRSF: SOFTWARE RESET FLAG
D3	(08H): WDTRSF: WATCHDOG TIMER RESET FLAG
D2	(04H): MCDRSF: MISSING CLOCK DETECTOR FLAG
D1	(02H): PORSF: POWER-ON RESET FLAG
D0	(01H): PINRSF: HW PIN RESET FLAG

12 Operating Software

Comprehensive operating software is provided for the SYSKON Konstanter (on the included CD-ROM, or can be downloaded from our website).

The software is started by running the EXE file; no further installation is required.

The software detects devices which are connected to the various possible interfaces including USB, RS 232 and GPIB. Devices detected by the software are identified and can be selected. If more than one device is connected, the software can be started several times in order to operate them.



The activated device logs on via the soft front panel and is thus unequivocally recognized.

Sub-menus

Further operation can be carried out as shown in the figures.

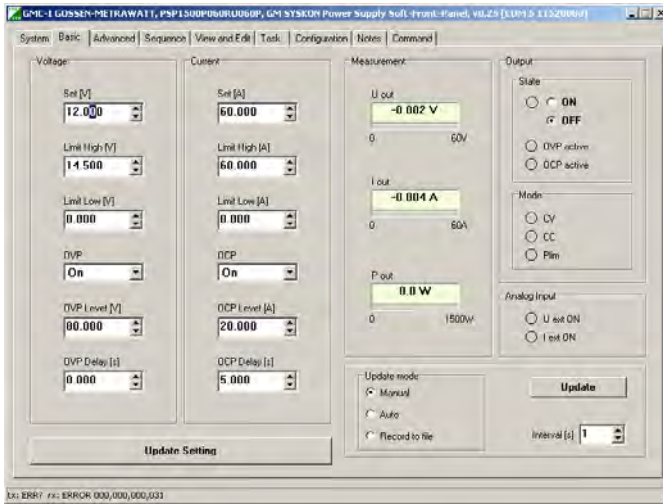

Basic panel

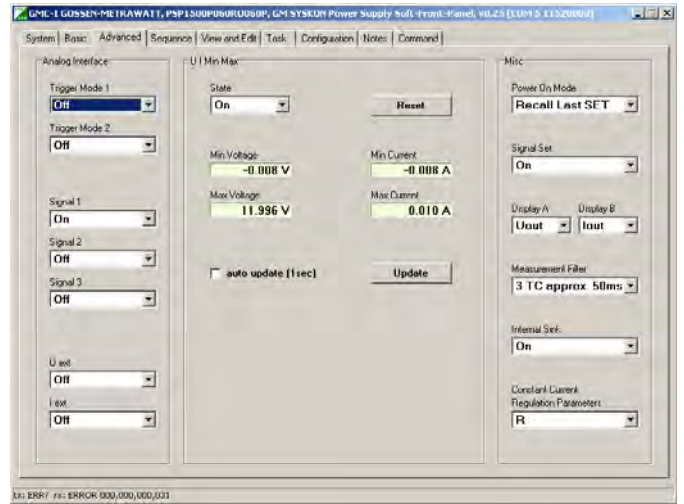

Advanced panel

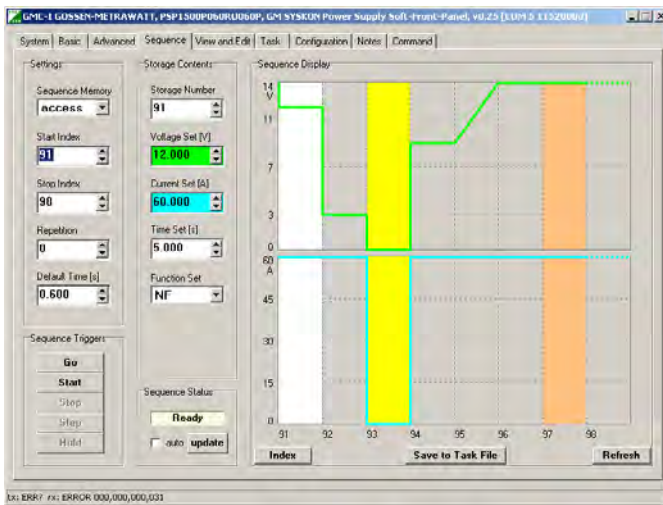

Sequence panel

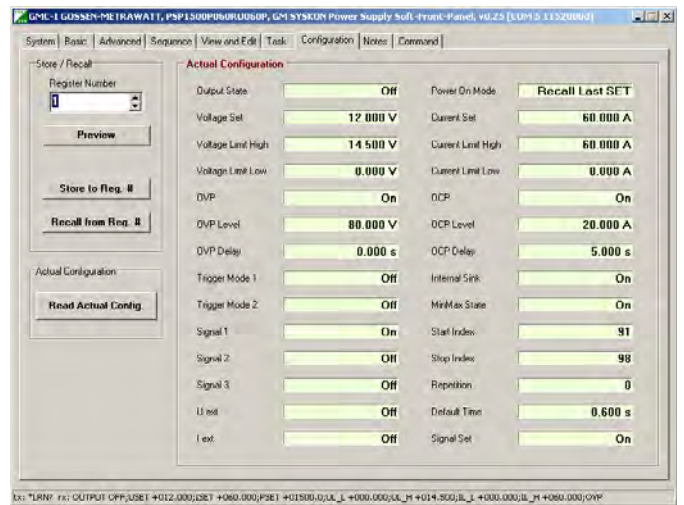

Configuration panel

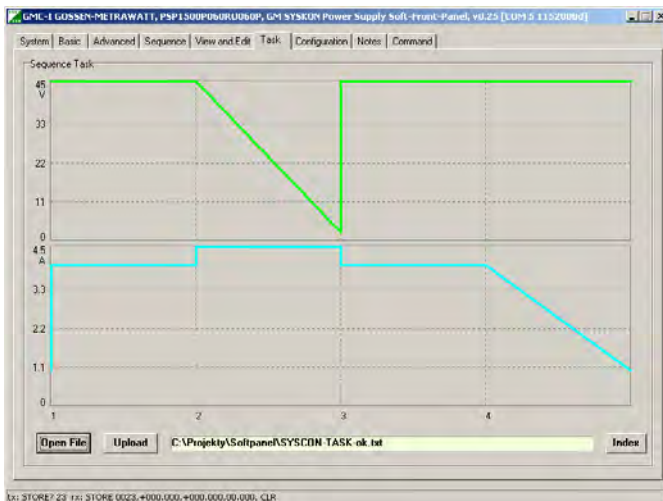

Task panel

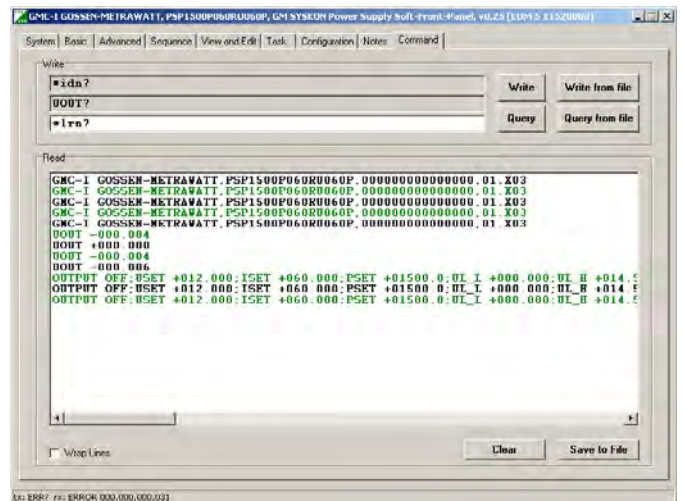

Command panel

13 Index

C

Control Mode Query	
PC Query	47

D

Device Settings	
Current Settings	
Query from PC	40
Save	
Via PC	42
From Setup-Sequence Memory	
Accept	
Via PC	41
Reset	
Via PC	41
Transfer to / Query from Sequence Memory	
Via PC	53

Digital Displays

Switch On and Off via PC	44
--------------------------	----

I

Interface

Installation	6
Parameter Setting	26
Technical Data	7

M

Min-Max Memory

Display	
Via PC	46, 55
Edit	
Via PC	47

O

Operating Commands

List of Setting Commands	58
--------------------------	----

Output Current

Measured Value	
PC Query	46
Setpoint	
Via PC	47
Setting Limit	
Via PC	46, 54

Output Power

PC Query	50
----------	----

Output Switching stazs

Response at Power On	
Via PC	50

Output Swithing Status

Switch/Query	
Via PC	49

Output Voltage

Measured Value	
PC Query	55
Setpoint	
Via PC	55

Overcurrent Protection

Activate/Deactivate	
Via PC	48

Q

Query Device ID	40
-----------------	----

R

RESET	39
Response after Power On with Varying Line Voltage Ranges	8

S

Self-Test via PC	42
------------------	----

Sequence

Control	
Via PC	51
Dwell Time	
Memory Location Independent	
Via PC	53
Memory Location Specific	
Via PC	54
Repetitions	
Via PC	51

Start Address

Via PC	53
--------	----

Status and Event Management

Clear Event Register	39
Device Clear Function	44
Enable Registers	40
Event Register Query	40
Individual Status Query	40
Operation Complete Query	41
Power-On Status Clear Query	41
Status Byte Register Query	42
Status Register Query	44
Wait to Continue	42

Stop Address

Via PC	53
--------	----

System Messages, Error Messages

Via PC	64
--------	----

T

Trigger Digital

Define Device Trigger	39
Trigger	42

Trigger Response

Edit	
Via PC	54

W

Waiting Time	55
--------------	----

14 Order Information

Description (abbreviated name)	Article Number
SYSKON P500-060-030 SYSTEM KONSTANTER	K346A
SYSKON P800-060-040 SYSTEM KONSTANTER	K347A
SYSKON P1500-60-60 SYSTEM KONSTANTER	K353A
SYSKON P3000-060-120 SYSTEM KONSTANTER	K363A
SYSKON P4500-060-180 SYSTEM KONSTANTER	K364A
Option IEEE 488 interface for SYSKONKONSTANTER	K384A

Software

Further information regarding operating software and drivers is available for download on the internet:

<http://www.gossenmetrawatt.com>

Accessories

Description	Note	Article No.
RS 232 bus cable, 2 m	For connecting a device to an RS 232 interface (extension cable, 9-pin socket / 9-pin plug connector)	GTZ32410 00R0001

15 Repair and Replacement Parts Service Calibration Center* and Rental Instrument Service

If required please contact:

GMC-I Service GmbH
Service Center
Thomas-Mann-Str. 20
90471 Nürnberg, Germany
Phone: +49 911 817718-0
Fax: +49 911 817718-253
e-mail service@gossenmetrawatt.com
www.gmci-service.com

This address is only valid in Germany. Please contact our representatives or subsidiaries for service in other countries.

* DAkkS Calibration Laboratory for Electrical Quantities D-K-15080-01-01 accredited per DIN EN ISO/IEC 17025

Accredited quantities: direct voltage, direct current value, direct current resistance, alternating voltage, alternating current value, AC active power, AC apparent power, DC power, capacitance, frequency, temperature

Competent Partner

GMC-I Messtechnik GmbH is certified in accordance with DIN EN ISO 9001.

Our DAkkS calibration laboratory is accredited by the Deutsche Akkreditierungsstelle GmbH (National accreditation body for the Federal Republic of Germany) in accordance with DIN EN ISO/IEC 17025 under registration number D-K-15080-01-01.

We offer a complete range of expertise in the field of metrology: from **test reports** and **factory calibration certificates**, right on up to **DAkkS calibration certificates**.

Our spectrum of offerings is rounded out with free test equipment management.

Our service department includes an **on-site DAkkS calibration bench**. If errors are discovered during calibration, our specialized personnel are capable of completing repairs using original replacement parts.

As a full service calibration lab, we can calibrate instruments from other manufacturers as well.

16 Product Support

If required please contact:

GMC-I Messtechnik GmbH
Product Support Hotline
Phone: +49 911 8602-0
Fax: +49 911 8602-709
e-mail: support@gossenmetrawatt.com

17 Manufacturer's Guarantee

The SYSKON Konstanter is guaranteed for a period of 2 years after shipment. The manufacturer's guarantee covers materials and workmanship. Damages resulting from use for any other than the intended purpose, as well as any and all consequential damages, are excluded.

Calibration is guaranteed for a period of 12 months.

Edited in Germany • Subject to change without notice • PDF version available on the Internet

 **GOSSEN METRAWATT**

GMC-I Messtechnik GmbH
Südwestpark 15
90449 Nürnberg • Germany

Phone +49 911 8602-111
Fax +49 911 8602-777
E-Mail info@gossenmetrawatt.com
www.gossenmetrawatt.com