

# MULTIMETER EPM-04 / 04C / 04CS

# MULTIMETER EPM-04 / 04C / 04CS

### Dimensions

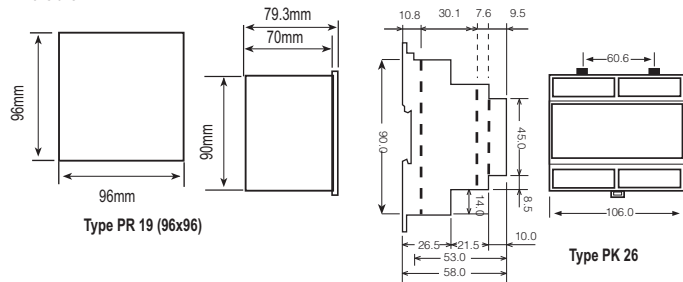

### Panel Cut-out

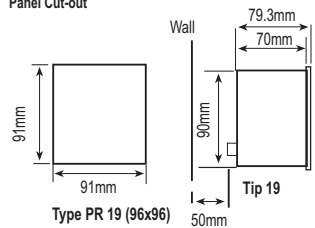

### Connection Diagram

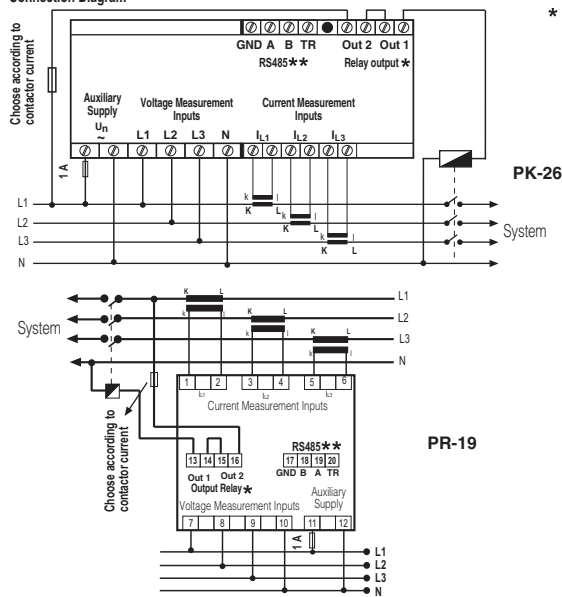

.. Available only for EPM-04C/04CS  
 \*\* Available only for EPM-04CS  
 Note: For CT-25 models:  
 k: When CT-25 is used, Red cable is connected to k terminal.  
 l: When CT-25 is used, Black cable is connected to l terminal.

### Summary of the Contact Operations \*

	ALTERNATIVE 1 (U-I)	ALTERNATIVE 2 (H-L)
Out 1	Current --> Under/Over	Voltage --> Under Frequency --> Under Current --> Under Phase Seq.
Out 2	Voltage --> Under/Over Frequency --> Under/Over Phase Seq.	Voltage --> Over Frequency --> Over Current --> Over

\* Valid for EPM-04C/04CS

### INDEX

Precautions for Installation and Safe Usage.....1  
 Front Panel and Usage of Buttons.....1  
 General Information and Applications.....1  
 Using The Buttons.....2  
 Transformer Menu (Tr / Trn / Ubr / ConvE/Con).....2  
 User Password Settings (Pin Menu).....2  
 Activating the User Password (Pin Act Menu).....2  
 Changing the User Password (Pin Chg Menu).....2  
 Output Setting Menu.....3  
 Current Setting Menu (SP Current Menu).....3  
 High/Low Current Settings (SP Cur Hi, SP Cur Lo Menu).....3  
 Hysteresis Settings for High/Low Currents (I-H Hys, I-L Hys Menu).....3  
 Delay-on Time for High/Low Currents (I-H ond, I-L ond Menu).....3  
 Delay-off Time for High/Low Currents (I-H ofd, I-L ofd Menu).....3  
 Start and Auto Function (StAr t dEL and Auto rSt Menu).....4  
 Instant Trip Function (Cur inS trP Menu).....4  
 Voltage Setpoint Menu (SP Volt Menu).....4  
 High/Low Voltage Settings (SP UoL Hi, SP UoL Lo Menu).....4  
 Hysteresis Settings for High/Low Voltages (U-H Hys, U-L Hys Menu).....5  
 Delay-on Time for High/Low Voltages (U-H ond, U-L ond Menu).....5  
 Delay-off Time for High/Low Voltages (U-H ofd, U-L ofd Menu).....5  
 Frequency Menu.....6  
 High/Low Frequency Settings (Frq Hi, Frq Lo Menu).....6  
 Hysteresis Settings for High/Low Frequencies (F-H Hys, F-L Hys).....6  
 Delay-on / Delay-off Time for High/Low Frequencies (Frq ond, Frq ofd).....6  
 Phase Sequence (Voltage Sequence Menu) and Instant Trip (UoL inS trP Menu) Menu.....6  
 Erasing the Max., Min. and Max. Demand Values (Reset Menu).....6  
 Demand Time for Demand and Max. Demand (dE t Menu).....7  
 Communication Menu (RS-485).....7  
 Technical Features and Default Factory Settings.....7  
 Connection Diagram.....8  
**Output, SP Current and SP Volt menus are available for EPM-04C/04CS; RS-485 menu is available for EPM-04CS.**

### PRECAUTIONS FOR INSTALLATION AND SAFE USE

- In CT-25 (120A) compliant models, only CT-25 current transformer must be used.
- Other type of CT's have a high risk to damage to device.
- Failure to follow those instructions will result in death or serious injury.
- Disconnect all power before working on equipment.
- When the device is connected to the network, do not remove the front panel.
- Do not try to clean the device with solvent or the like. Only clean with dry cloth.
- Verify correct terminal connections when wiring.
- Electrical equipment should be serviced only by your component seller.
- Only for rack panel mounting.
- Fuse must be F type and limit value doesn't exceed 1A.
- No responsibility is assumed by manufacturer or any of its subsidiaries for any consequences arising out of the use of this material.

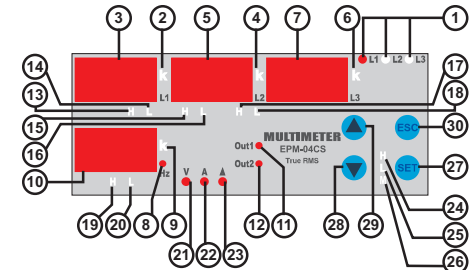
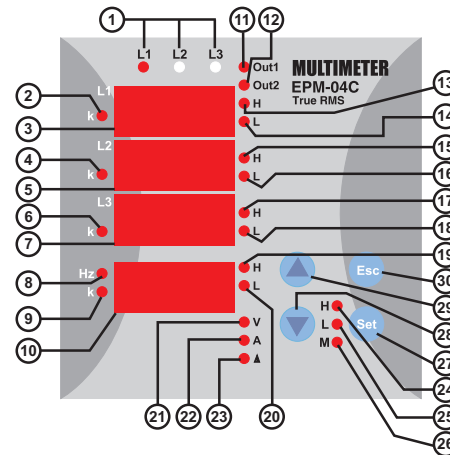

- Phase LEDs. The LEDs turn on when the voltage value, which is applied to one of the current inputs, reach 30 V
- First display's k LED (for L1). Measurement parameter is the unit of kilo when LED is turned on. ie: kA, kV
- Display for L1.
- Second display's k LED (for L2). Measurement parameter is the unit of kilo when LED is turned on. ie: kA, kV
- Display for L2.
- Third display's k LED (for L3). Measurement parameter is the unit of kilo when LED is turned on. ie: kA, kV
- Display for L3.
- Displays network frequency when Hz LED is turned on.
- k LED for neutral current. Measurement parameter is displayed in unit of kilo when this LED is turned on.
- Display for neutral current and frequency (for EPM-04C/04CS).
- First warning output LED (Out1). Turned on when the output is activated.
- Second warning output LED (Out2). Turned on when the output is activated.
- Over current / voltage warning output for L1. (EPM-04C/04CS)
- Low current / voltage warning output for L1. (EPM-04C/04CS)
- Over current / voltage warning output for L2. (EPM-04C/04CS)
- Low current / voltage warning output for L2. (EPM-04C/04CS)
- Over current / voltage warning output for L3. (EPM-04C/04CS)
- Low current / voltage warning output for L3. (EPM-04C/04CS)
- Over current / frequency warning output for frequency and neutral current (EPM-04C/04CS).
- Low current / frequency warning output for frequency and neutral current (EPM-04C/04CS).
- Monitoring the L1, L2, L3 voltages values when V LED is turned on and displays the frequency in 4th display.
- Monitoring the L1, L2, L3 currents values when A LED is turned on and displays the neutral current in 4th display.
- Indicates the activating delta connection when Δ is turned on. Neutral current protection is deactivated even if is activated.
- H LED for max. instant current and voltage. Max. instant currents and voltages are displayed when this LED is turned on.
- L LED for min. instant current and voltage. Min. instant currents and voltages are displayed when this LED is turned on.
- M LED for max. demand. Max. demand values are displayed when this LED is turned on.
- SET button. It is used to enter into the menu and to save the values. If SET button is pressed for 3 sec. in the measurement mode, you can enter into menus. This button is used for monitoring the max. (H), Min. (L) current values and max. demand values in measurement mode.
- Downward selection button.
- Upward selection button.
- ESC button. Escaping from the menu. And also used for switching off the Latch function while this function has activated.

### General information

EPM-04/04C/04CS is designed for measuring Phase current, frequency, neutral current and voltages (Phase-Phase and Phase-Neutral) in a 3-Phase system.  
 EPM-04C/04CS:  
 Device has 2 warning output which named as Out1 and Out2. (NO-Normally Open) Please refer to "Output" menu for the functions of the relays.



# MULTIMETER

## EPM-04 / 04C / 04CS

### Below measurement and application can be implemented with EPM-04/04C/04CS.

- Phase currents (I<sub>L</sub>), Neutral current (I<sub>N</sub>), Phase-Phase and Phase-Neutral voltages can be measured.
- Existence of live phases can be observed by L1-L2-L3 LEDs on the device.
- Min. and max. values for measured currents and voltages can be monitored with only one button.
- Max. demand values for measured current can be monitored, demand time can be defined in "dE t" menu.
- A 4 digit password can be defined from pin menu in order to prevent the change of settings by unauthorized person.
- Current transformer ratio can be programmed in term of "turn number" between 1...20 (for CT-25 adapted devices).  
Voltage transformer ratio is programmable. (0.1 ... 4000)
- A user defined measurement range is used for monitoring the voltages and currents, and Out1 & Out2 outputs are used for warning the user and disconnecting the device in case of exceeding the limits of measurement range.
- In case of using the device for measuring the current values of motors etc., start delay (Auto rSt) function can be used for preventing the equipment against the improper tripping, which is because of the demurrage current.
- When a failure has occurred use the Latch function, in order to keep the device with saving its position (Latched), even if the failure conditions are removed.
- 7th, 8th and 9th subjects are valid for EPM-04C/04CS.

### Using the Buttons:

- Monitoring for phase currents (A LED is activated) or phase voltages (V LED is activated).
- Used for changing the menu settings and parameters in programming mode.
- Used for monitoring min. / max. currents and voltages or max. demand values. Switching to the programming mode if pressed for 3 sec. In programming mode; it is used for switching to the menu and saving changes for the parameters.
- Switching to the previous menu and escaping the programming menu without saving the changes.
- If the Latch function is turned on (EPM-04C/04CS); output will be released when current(s) of system is exceed the defined values. When the system's current turns back to normal values then output doesn't react. Output can be triggered by the "ESC" button.

### Commissioning the EPM-04C/04CS and menu setting:

Energize the device after implementing the connections respected to the user manual.  
Enter the proper menu settings in order to correct measurements and applications.

### Current Transformer Ratio Setup:

In this menu, current transformer ratio is set between 1 - 2000. (This menu is not available in the devices which are adapted with CT-25.)  
**Note:** If the current transformer is not used between the system and device, current transformer ratio is entered as '1'.  
**Example:** If a current transformer which has a ratio of 30/5A is used between the system and device;  
Current transformer ratio is entered as = 30/5 = 6.  
Press SET button for 3 sec. (trA Fo menu is displayed)

Press SET button: trA Fo Cr menu is displayed (In CT-25 adapted devices, trA Fo trn is displayed instead.)  
**Note:** trA Fo Ulr or Con nEC to n menu can be displayed by scrolling the UP/DOWN buttons.)

Press SET button: Blinking the first digit of displayed value appears. (trA Fo Ulr or Con nEC to n menu can be programmed similarly.)  
Enter the blinking digit value by scrolling UP/DOWN buttons. Switch to the other digits by using SET button, use ESC button to go to previous digit. After you entered the last digit press SET button. "trA Fo Cr" is displayed. (Data is entered but is not activated yet. For activating the new data please follow the below steps).

Press ESC button one by one until "SAU E SET YES" is displayed.  
Press SET button. When "SAU E SET YES" is displayed (If you press ESC button or choose "no" option instead of "YES" then new data will be cancelled and previous value will be activated).

Press SET button: trA Fo Cr menu is displayed (In CT-25 adapted devices, trA Fo trn is displayed instead.)  
Press SET button: Blinking the first digit of displayed value appears. (trA Fo Ulr or Con nEC to n menu can be programmed similarly.)

Enter the blinking digit value by scrolling UP/DOWN buttons. Switch to the other digits by using SET button, use ESC button to go to previous digit. After you entered the last digit press SET button. "trA Fo Cr" is displayed. (Data is entered but is not activated yet. For activating the new data please follow the below steps).

### Programming the Turn Number:

This menu is available for CT-25 adapted devices. User defines the turn number, which is the number of how many turn the current cable has rounded into the CT-25. Numbers can be selected between 1-20. Greater the number of turn means greater the sensitivity.

trn	1	2	3	4	5	6	7	8	9	10	11	12	13	14	15	16	17	18	19	20
trn min[A]	0.01	0.02	0.03	0.04	0.05	0.06	0.07	0.08	0.09	0.10	0.11	0.12	0.13	0.14	0.15	0.16	0.17	0.18	0.19	0.20
trn max[A]	20	0.40	0.30	0.24	0.20	0.17	0.15	0.13	0.12	0.10	0.09	0.08	0.07	0.07	0.07	0.07	0.07	0.07	0.07	0.07

### Voltage Transformer Ratio:

In this menu, voltage transformer ratio is set between 0000,1 - 4000,0.  
**Note:** If the voltage transformer is not used between the system and EPM-04, voltage transformer ratio is entered as '1'.  
**Example:** If a voltage transformer which has a ratio of 34.5KV/100V is used between the system and device; Voltage transformer ratio is entered as 345. (34500/100)

### Selecting the Connection Type :

Connection can be selected as Star or Delta in this menu.  
Phase-Neutral voltage monitoring can be implemented if the "Star" connection is selected.  
Phase-Phase voltage monitoring can be implemented if the "Delta" connection is selected.

### NOTE: When the "Delta" connection is selected, "neutral current monitoring" can be implemented even if it is activated.

### User Password Setup:

In this menu user password is defined and activated.  
You must define and activate a 4 digit user password for preventing device settings from the illegal usage.  
There are 2 sub menu in the Pin menu.

### Activating the user password :

This menu is used for activating the user password.  
After the user password is activated for entering to the menus; if the button is pressed for 3 sec., while the instant values are observed, user password is required. If the user password is entered wrong device does not latch.  
**Note:** Factory default value of user password is "0000"

For activating the user password, in the measurement mode Press SET button for 3 sec. (trA Fo menu is displayed.)

Find the "Pin" menu by scrolling UP/DOWN buttons.

Press SET button (Pin Act IUA IE is displayed.)

Press SET button. Blinking the first digit of displayed value appears.

Enter the blinking digit value by scrolling UP/DOWN buttons. Switch to the other digits by using SET button, use ESC button to go to previous digit. After you entered the last digit press SET button. "Pin Act" is displayed. (Data is entered but is not activated yet. For activating the new data please follow the below steps).

Press ESC button one by one until "SAU E SET YES" is displayed.

Press SET button. When "SAU E SET YES" is displayed (If you press ESC button or choose "no" option instead of "YES" then new data will be cancelled and previous value will be activated).

### Changing of User Password:

This menu is used for changing the user password.  
**Note:** Factory default value for user password is "0000"

For activating the user password, in the measurement mode Press SET button 3 sec. (trA Fo menu is displayed.)

Find the "Pin" menu by scrolling UP/DOWN buttons.

Press SET button (Pin Act IUA IE is displayed.)

Find the "Pin CHA n9E" menu by scrolling UP/DOWN buttons.

# MULTIMETER

## EPM-04 / 04C / 04CS

Press ESC button one by one until "SAU E SET YES" is displayed.

Press SET button. When "SAU E SET YES" is displayed (If you press ESC button or choose "no" option instead of "YES" then new data will be cancelled and previous value will be activated).

### Serial Communication (for EPM-04CS)

EPM-04CS have MODBUS RTU communication protocol which is optical isolated. All measured parameters can be transfer to the computer. Transformer ratios and communication parameters can be set. Saved values can be reset.  
Programmed parameter for communication explained below.

Press SET button 3 sec. (trA Fo menu is displayed.)

Find RS-485 menu by scrolling UP/DOWN buttons.

Press SET button (Adr ESS menu is displayed.)

Find "Adr ESS / bAU d / PAnTy" menu by scrolling UP/DOWN buttons.

Press SET button ("001 / 9600 / no" menu is displayed.)

Enter the parameter values by scrolling UP/DOWN buttons (001...247 / 2400...38400 / no, EUEn, odd).

Press SET button, "Adr ESS / bAU d / PAnTy" is displayed. (Data is entered but is not activated yet. For activating the new data please follow the below steps)

Press ESC button one by one until "SAU E SET YES" is displayed.

Press SET button. When "SAU E SET YES" is displayed (If you press ESC button or choose "no" option instead of "YES" then new data will be cancelled and previous value will be activated).

### MODBUS RTU PROTOCOL (Available only for EPM-04CS)

Standard MODBUS RTU message is shown below.

T	ADDRESS 8 BIT	FUNCTION 8 BIT	DATA NxBIT	CRCH	CRCL	T
---	---------------	----------------	------------	------	------	---

The T times corresponds to a time in which data must not be exchanged on the communication bus to allow the connected devices to recognize the end of one message and the beginning of another. This time must be at least 3.5 characters at the selected baud rate. Address range (1-247) is address of the connected device. The data field contains data sent to the slave by master or data sent to master by slave.  
CRC is a error check method by using MODBUS RTU protocol and consists of 2 bytes.

### Available Modbus Function:

03H	READ HOLD REGISTERS
04H	PRESET SINGLE REGISTER
10H	PRESET MULTIPLE REGISTERS

Read Hold (03) function is used for reading measured values and set value. If any request of reading of a register, excepted mentioned in register table, device will send an error message.

For example to read phase1 voltage by sending a message to the device.  
01 03 00 00 00 02 XX XX  
01 Device address  
03 Function  
00 MSB address  
00 LSB address

00 Register number MSB  
02 Register number LSB  
XX CRC MSB  
XX CRC LSB  
Preset Single Register (06) function is used for writing the setting values, erasing the energy counter or resetting the min., max., demand values. Current transformers ratio can be set 0-2000, voltage transformer ratio can be set 1-40000.  
i.e. Setting CT as 100;  
01 Device address  
01 06 80 02 00 64 XX XX  
01 Function  
80 MSB address  
02 LSB address  
00 Data MSB  
64 Data LSB  
XX CRC MSB  
XX CRC LSB

Preset Multiple Register (10H) is used to set more than one register at same time.  
i.e. Setting CT as 100, UI as 20.0;  
01 10 80 00 00 02 04 00 C8 00 64 XX XX  
01 Device Address  
10 Function  
80 MSB address  
00 LSB address  
00 Register number MSB  
02 Register number LSB  
04 Byte count  
00 Data MSB  
64 Data LSB  
C8 Data LSB  
00 Data MSB  
64 Data LSB  
XX CRC MSB  
XX CRC LSB

### EPM-04CS COMPUTER CONNECTION

31 DEVICES CAN BE CONNECTED AT THE SAME LINE

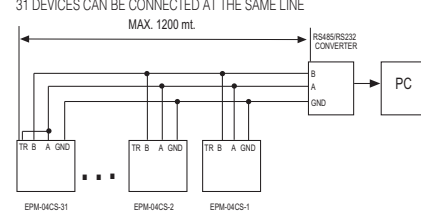

MAX. 247 DEVICES CAN BE CONNECTED AT SAME LINE BY USING REPEATER.

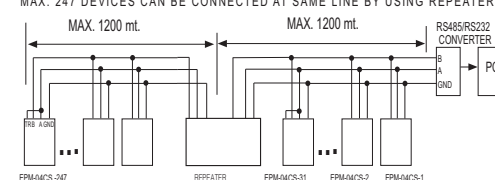

### Technical Features

Rated Voltage (Un)	: Please look at back side of the device.
Operating frequency (f)	: 45-65 Hz
Auxiliary Supply Power Consumption	: < 4 VA
Measuring Input Power Consumption	: < 1 VA
Measurement range	
Current	: 0.05-5.5A-
	: 2 - 120 A- for CT-25
Voltage	: 10-300 V AC (Phase - Neutral)
	: 10-500 V AC (Phase - Phase)
	: ±1% digit (110%-100%) x full scale]
Turn number for CT-25 adapted models	: 1 ... 2000
Voltage Transformer Ratio	: 1 ... 4000
Max. Ctr x Vr	: 40.000
Communications (for EPM-04CS)	: MODBUS RTU (RS 485)
	: Optic isolated, programmable
	: 2400-4800-9600-19200-38400 bps
Baud Rate (for EPM-04CS)	: 1-247
Address (for EPM-04CS)	: No. Odd, Even, 8 Data Bits, 2 Stop Bits
Parity (for EPM-04CS)	: 2 NO, 250 V AC, 5A, 1250 VA
Output Relay(s) for EPM-04C/04CS)	: -5°C; +50°C
Ambient Temperature	: Red LED display
Display	: PR-19, PK-26
Dimensions	: Double Insulation - Class II (II)
Equipment Protection Class	: IP 40
Box Protection Class	: IP 00
Terminal Protection Class	: Nonflammable
Box Material	: Panel Mounted (PR-19)
Mounting	: Rail Mounted (PK-26)
Wire Cross section (for terminals)	: 2.5 mm²
Weight	: 0.56 kg (PR-19)
	: 0.53 kg (PK-26)
Mounting Category	: Class III
Panel Size	: 91x91 mm (PR-19)
	: 46x107 mm (PK-26)

Rated Voltage (Un) : Please look at back side of the device.  
Operating frequency (f) : 45-65 Hz  
Auxiliary Supply Power Consumption : < 4 VA  
Measuring Input Power Consumption : < 1 VA  
Measurement range :  
Current : 0.05-5.5A-  
Voltage : 2 - 120 A- for CT-25  
Turn number for CT-25 adapted models : 1 ... 2000  
Voltage Transformer Ratio : 1 ... 4000  
Max. Ctr x Vr : 40.000  
Communications (for EPM-04CS) : MODBUS RTU (RS 485)  
Optic isolated, programmable  
2400-4800-9600-19200-38400 bps

Baud Rate (for EPM-04CS) : 1-247  
Address (for EPM-04CS) : No. Odd, Even, 8 Data Bits, 2 Stop Bits  
Parity (for EPM-04CS) : 2 NO, 250 V AC, 5A, 1250 VA  
Output Relay(s) for EPM-04C/04CS) : -5°C; +50°C  
Display : Red LED display  
Dimensions : PR-19, PK-26  
Equipment Protection Class : Double Insulation - Class II (II)  
Box Protection Class : IP 40  
Terminal Protection Class : IP 00  
Box Material : Nonflammable  
Mounting : Panel Mounted (PR-19)  
Rail Mounted (PK-26)  
Wire Cross section (for terminals) : 2.5 mm²  
Weight : 0.56 kg (PR-19)  
0.53 kg (PK-26)  
Mounting Category : Class III  
Panel Size : 91x91 mm (PR-19)  
46x107 mm (PK-26)

### Default Settings

/5A type			
Ctr	- 0001	I-H L-1 - 5.000	I-L L-2 - 0.000
Ulr	- 0001	I-H L-2 - 5.000	I-L L-3 - 0.000
trn	- 001	I-H L-3 - 5.000	I-L L-n - 0.000
ConnEC	- StAr	I-H L-n - 5.000	I-L HyS - 0.200
Pin Act	- 0000	I-H HyS - 0.100	I-L ond - 0.100
Pin	- 0000	I-H ofd - 010.0	I-L ofd - 010.0
dt	- 15	I-H ofd - 010.0	Str Ar del - 0.000
		I-L L-1 - 0.000	Auto reset - oFF
			Cur ins trip - oFF
		U-H L-1 - 250	Frq Hi - 63
		U-H L-2 - 250	F-H HyS - 01.00
		U-H L-3 - 250	Frq Lo - 47
		U-H HyS - 10	F-L HyS - 01.00
		U-H ond - 003.0	Frq ond - 003.0
		U-H ofd - 003.0	Vol. inS triP - oFF
		U-L L-1 - 180	Auto reset - oFF
		U-L L-2 - 180	Cur ins trip - oFF

### CT-25 type

I-H L-1	- 100.0	I-L L-2	- 0.000
I-H L-2	- 100.0	I-L L-3	- 0.000
I-H L-3	- 100.0	I-L L-n	- 0.000
I-H L-n	- 100.0	I-L HyS	- 2.000
I-H HyS	- 2.000	I-L ond	- 010.0
I-H ofd	- 010.0	I-L ofd	- 010.0
I-H ofd - 010.0		Str Ar del	- 0.000
I-L L-1 - 0.000		Auto reset	- oFF
		Cur ins trip	- oFF

# MULTIMETER EPM-04 / 04C / 04CS

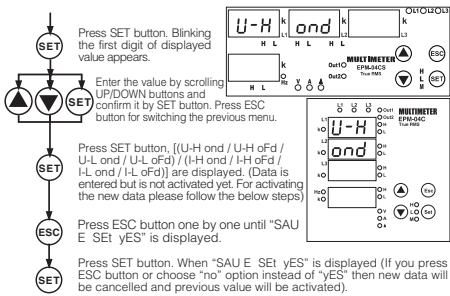

### Setpoints for Frequency :

In this menu, Frequency range can be defined according to High and Low values of Frequency measurement.

If the frequency of the system decreases the Frq Hi value; output is switched on and LED is turned on. (Refer to Output menu) and H LED for frequency is turned off.

If the frequency of the system exceeds the high set value, H LED relating to frequency blinks, output switched off at the end of defined time (Frq Ond), LED turned off (Refer to Output menu) and H LED for frequency is turned on continuously.

If the frequency of system are under the high set value (Frq Hi) as a hysteresis (F-H HYS), output is turned on at the end of defined time (Frq oFd), LED is turned on and H LED is turned off, at the end of the adjusted time (Frq Ofd), output1 LED turns on and Hi LEDs turn off.

If the frequency of the system is over the low set value (Frq Lo), output is turned on, LED is turned on L LED is turned off.

If the frequency of the system decreases the low set value (Frq Lo), L LED blinks; output is turned off at the end of defined time (Frq Ond), LED is turned off and L LED is turned on continuously.

If the frequency of the system is over the low set value (F-L HYS) as a hysteresis (Frq Hys), output is turned on at the end of defined time (Frq Ofd), LED is turned on and L LED is turned off.

**Note:** System frequency is measured for L1.

There are 6 submenus.

Frq Hi, Frq Lo, F-H HYS, F-L HYS, Frq Ond, Frq oFd.

**Frq** Max. value for system frequency, this value can be defined between 0...70.00 Hz. If the value is set to zero (0), the high frequency warning is disabled.

**Frq** Min. value for system frequency, this value can be defined between 0...70.00 Hz. If the value is set to zero (0), the low frequency warning is disabled.

**Lo** **Note:** Attention for common using of output and relay LED for voltage.

**F-H** In this menu, required hysteresis value can be defined between 0...20.00 Hz. in order to switching off the "high frequency" warning.

**F-L** In this menu, required hysteresis value can be defined between 0...20.00 Hz. in order to switching off the "low frequency" warning.

**HYS** Delay-on time for activation of alarm for high and low frequency value.

**ond** This value can be defined between 000.0...999.9 in term of second..

**Frq** Delay-off time for deactivation of alarm for high and low frequency value.

**oFd** This value can be defined between 000.0...999.9 in term of second.

Phase sequence can be turned on/off in this menu. Inversed phase voltage which is applied to the measurement inputs (L1-L2-L3), can be monitored. Default setting is off. In order to let the device to warn user in case of inversed phase situation please change the off position as on in "UoL PHS SEq" menu. Phase sequence function is disabled if the selection is selected off.

L1, L2 and L3 LEDs blink and output output released immediately when "UoL PHS SEq" is turned on and phase sequence is inversed with any reason.

**Note:** Output 2 is used if U-I is selected and Output1 is used if H-L is selected in Output menu for the Phase Sequence monitoring.

### Instant Tripping Function.

At position ON, if any VLL / VL-N values exceeds 1.5 times of high voltages (UoL Hi L1-L2/L-3) values; the "voltage output" switches OFF instantly, output LED turned OFF and H LED, for related voltage, is turned ON. (Please refer to "Output".)

If any phase voltage decrease 0.5 times low voltages (UoL L-1/L-2/L-3); the "voltage output" switches OFF instantly, output LED turned OFF and Lo LED, for related voltage, is turned ON.

(Refer to Page-4 for "Cur inS trP", "Aut o rSt" and "UoL inS trP")

**rES** **Et** **Reset function.** In this menu, values of min., max., max. demand are erased. It saves the instantaneously measured min. and max. values of the device into its memory. Please kindly look at to the section of **FUNCTIONS OF BUTTONS** for min. and max. values.

**Note:** Measured electrical parameters which are saved to the memory are not affected from the electric interruptions. In the rES Et HL or rES Et dE menu; when you choose yES and quit from all menus; if you confirm the changes, min., max. and max. demand values of all parameters are erased at the same time.

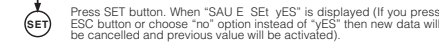
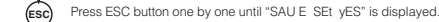
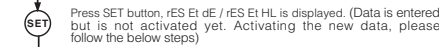
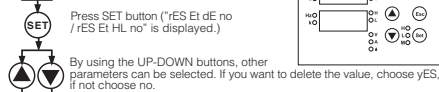

### dE t i Demand Time.

Max. Demand time can be defined between 01-60 minute in this menu.

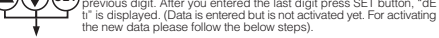
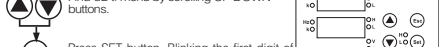
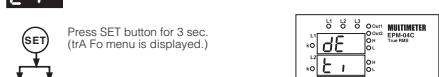

# MULTIMETER EPM-04 / 04C / 04CS

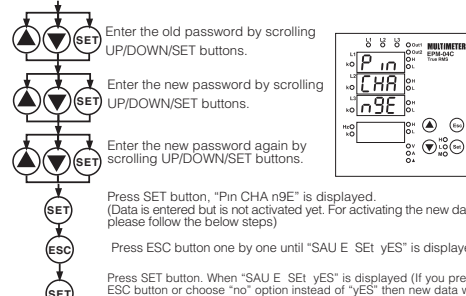

**OutPut** In this menu, using of oUt PUt function is explained with details below.

**Out Relay function:** In this menu high-low or voltage-current monitoring is determined for Out1 and Out2 outputs.

**Note:** When U-I (voltage-current) is selected; Out2 is monitoring according to high or low voltage, frequency values and phase sequence, Out1 is monitoring according to high or low-current value.

When H-L (high-low) is selected; Out2 is monitoring according to high values for voltage, frequency and low-current, Out1 is monitoring according to low values for voltage or current.

Please refer to page 8 for a summary of the contact operations.

**Out Latch function:** If the Latch function is turned on; OUT1-OUT2 outputs, which are released when a failure is occurred, keep remained at its position even if the failure is over. Press (L) button in order to triggering the relay when the failure situation is removed.

If the Latch function is turned off; Released outputs triggered at the end of delay off time when the failure situation is removed.

**Out Inverse function:** If "oUt inU ErS" function is selected off; Device is started with closed output contacts (out1, out2) in the normal network conditions according to settings.

Otherwise devices started with open position of the contacts. Default setting is "off".

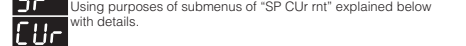
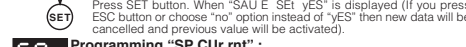
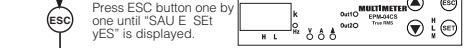
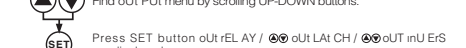
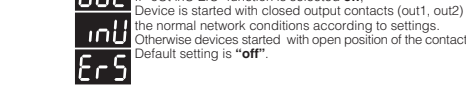

**Δ In case of using the device for measuring the current values of motors etc., start delay (Auto rSt) function can be used for preventing the equipment against the improper tripping, which is because of the demurrage current. If the system current decreases 50mAxCtr then start-up delay is resetted and related output detect the system automatically. This feature must be observed in case of using this function.**

In this menu, high set points for current values are programmed. Hi-values for IL1, IL2, IL3 and IN can be entered one by one. If all the current values are under the Hi value; Output1 output is switched on, LED of Output1 turned on and LED of H turned off.

If any current (IL1, IL2, IL3 and IN) exceeds the high set value, H LED blinks, Output1 output switches off at the end of the defined time (I-H ond), Output1 LED turned off and H LED turned on continuously.

If all currents (IL1, IL2, IL3 and IN) are below the high set value (Hi) as a hysteresis current (I-H HYS), output1 output switches on at the end of the defined time (I-H Ofd), output1 LED turned on and H LED turned off.

This menu has 7 sub menus. I-H L-1, I-H L-2, I-H L-3, I-H L-n, I-H HYS, I-H ond, I-H oFd

**Note:** High Current values are programmed for IL1, IL2, IL3 and IN separately but I-H HYS (hysteresis), I-H ond (delay on time) and I-H oFd (delay off time) values are common and they have same values for IL1, IL2, IL3 and IN.

**SP** **Cur** **H** In this menu, low set points for current values are programmed. Lo values for IL1, IL2, IL3 and IN can be entered one by one. If all the current values are over the Lo value; Output1 output is switched on, LED of Output1 turned on and LED of L turned off.

If any current (IL1, IL2, IL3 and IN) exceeds the low set value, L LED blinks and Output1 output switches off at the end of the defined time (I-L ond), Output1 LED turned off and L LED turned on continuously.

If all currents (IL1, IL2, IL3 and IN) are over the low set value (Lo) as a hysteresis current (I-L HYS), output1 output switches on at the end of the defined time (I-L Ofd), output1 LED turned on and L LED turned off.

This menu has 7 sub menus. I-L L-1, I-L L-2, I-L L-3, I-L L-n, I-L HYS, I-L ond, I-L oFd

**Note:** Low Current values are programmed for IL1, IL2, IL3 and IN separately but I-L HYS (hysteresis), I-L ond (delay on time) and I-L oFd (delay off time) values are common and they have same values for IL1, IL2, IL3 and IN.

**I-H** In this menu, max. current value for IL1 is programmed. The current value can be programmed between;

0.001...5,000 A (Cr = 1); 0.001...120.0 A (for CT-25 adapted device trm=1)

If the value is set to zero (0), the high current warning is disabled (I-H L-2 and I-H L-3 are programmed similarly). Refer "SP Cur Hi" for details.

**I-L** In this menu, min. current value can be programmed between;

0.001...5,000 A (Cr = 1); 0.001...120.0 A (for CT-25 adapted device trm=1)

If the value is set to zero (0), the low current warning is disabled (I-L L-2 and I-L L-3 are programmed similarly). Refer "SP Cur Lo" for details.

**I-H** In this menu, required hysteresis current for high current warning is programmed. (same for IL1, IL2, IL3 and IN.)

The current value can be programmed between; 0.001...2,500 A (Cr = 1)

Refer "SP Cur Hi" for details.

**HYS** In this menu, required hysteresis current for low current warning is programmed. (same for IL1, IL2, IL3 and IN.)

The current value can be programmed between; 0.001...2,500 A (Cr = 1)

Refer "SP Cur Hi" for details.

**I-L** In this menu, required hysteresis current for high current warning is programmed. (same for IL1, IL2, IL3 and IN.)

The value can be programmed between 000.0 and 999.9 in terms of seconds.

(Refer "SP Cur Hi" for details.)

**ond** Delay time for activating the output for low current warning. It is common for all currents (IL1, IL2, IL3 and IN)

The value can be programmed between 000.0 and 999.9 in terms of seconds.

(Refer "SP Cur Lo" for details.)

**I-L** Delay time for releasing the output for high current warning. It is common for all currents (IL1, IL2, IL3 and IN)

The value can be programmed between 000.0 and 999.9 in terms of seconds.

(Refer "SP Cur Hi" for details.)

**oFd** Delay time for releasing the output for low current warning. It is common for all currents (IL1, IL2, IL3 and IN)

The value can be programmed between 000.0 and 999.9 in terms of seconds.

(Refer "SP Cur Lo" for details.)



# MULTIMETER EPM-04 / 04C / 04CS

## Programming the "SP C<sub>Ur</sub> Hi", "SP C<sub>Ur</sub> Lo", "SP UoL Hi" and "SP UoL Lo".

Press SET button for 3 sec. (trA Fo menu is displayed.)

Find "SP C<sub>Ur</sub> rnt / SP UoL t" menu by scrolling UP-DOWN buttons.

Press SET button. "SP C<sub>Ur</sub> Hi / SP UoL Hi" menu is displayed.

Find [(SP C<sub>Ur</sub> Hi/SP C<sub>Ur</sub> Lo) / (SP UoL Hi/SP UoL Lo)] menu by scrolling UP-DOWN buttons.

Press SET button [(I-H L-1/L-1 L-1) / (U-H L-1/U-L L-1) menu is displayed.]

Press SET button. Blinking the first digit of displayed value appears.

Enter the blinking digit value by scrolling UP/DOWN buttons. Switch to the other digits by using SET button, use ESC button to go to previous digit. After you entered the last digit press SET button. "(I-H L-1/U-L L-1) / (U-H L-1/U-L L-1)" is displayed. (Data is entered but is not activated yet. For activating the new data please follow the below steps).

Press ESC button one by one until "SAU E SET yES" is displayed.

Press SET button. When "SAU E SET yES" is displayed (if you press ESC button or choose "no" option instead of "yES" then new data will be cancelled and previous value will be activated).

**Start-up delay:**  
Start Delay Time is used to prevent from faulty switchings caused by motor start-up current (demurrage current).  
If **Auto Reset** function is selected as ON; Each time that the current decreases "50mAxCtr" value, start-up delay time is reset and when the current value increases "50mAxCtr", start-up delay function is activated.  
If **Auto Reset** function is selected as OFF; If the power supply is switched off and then switched on, start-up delay function is activated.

**Auto Reset Function:**  
If **Auto Reset** function is selected as ON; Each time that the current decreases "50mAxCtr" value, start-up delay time is reset and when the current value increases "50mAxCtr", start-up delay function is activated.  
If **Auto Reset** function is selected as OFF; If the power supply is switched off and then switched on, start-up delay function is activated.

Please refer to below graphics for the operating principle of STA r t dEL and Aut o rSt functions

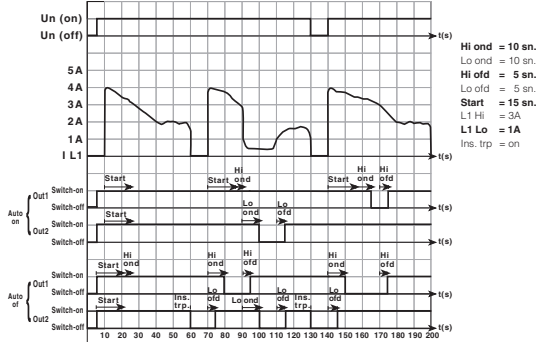

**Instant Tripping Function.**  
At position ON, if any phase current (IL1, IL2, IL3 and IN) exceeds 1.5 times of high (I-H L-1, I-H L-2, I-H L-3, I-H L-n) values, the "current output" switches off instantly, output LED turned off and H LEDs for related currents turned on. (Please refer to "Output".)  
At position OFF, if any phase current (IL1, IL2, IL3 and IN) decrease 0.5 times of low (I-L L-1, I-L L-2, I-L L-3, I-L L-n) values, the "current output" switches off instantly, output LED turned off and L LEDs for related currents turned on. (Please refer to "Output".)  
At position OFF, instant tripping function is cancelled.

## Programming "C<sub>Ur</sub> inS trP", "Aut o rSt" and "UoL inS trP"

Press SET button for 3 sec. (trA Fo menu is displayed.)

Find "SP C<sub>Ur</sub> rnt / SP UoL t" menu by scrolling UP-DOWN buttons.

Press SET button (SP C<sub>Ur</sub> Hi / SP UoL Hi menu is displayed.)

Find [(C<sub>Ur</sub> inS trP / Aut o rSt) / UoL inS trP] menu by scrolling UP-DOWN buttons.

Press SET button [(C<sub>Ur</sub> inS trP on / Aut o rSt on) / UoL inS trP off] is displayed.

Select "on" in order to activating the "instant trip function" (Aut o rSt), select "off" in order to deactivating the "instant trip function", by scrolling UP/DOWN buttons.

Press SET button, [(C<sub>Ur</sub> inS trP / Aut o rSt) / UoL inS trP] is displayed. (Selection is entered but is not activated yet. For activating the new data according to the below steps).

Press ESC button one by one until "SAU E SET yES" is displayed.

Press SET button. When "SAU E SET yES" is displayed (if you press ESC button or choose "no" option instead of "yES" then new data will be cancelled and previous value will be activated).

**Programming "SP UoL t":**  
Using purposes of submenus of "SP UoL t" explained below with details.

In this menu, high set points for voltage values are programmed. Hi values for Phase-Neutral / Phase-Phase (according to Star / Delta selection) can be entered one by one.

If all the voltage values (Phase-Neutral / Phase-Phase) are under the Hi value; related relay is switched on, its LED turned on (please refer "Output") and related H LEDs are turned off.  
If all the voltage values (Phase-Neutral / Phase-Phase) are over the Hi value; H LED blinks and related output is switched off at the end of "delay on time" (U-H onD), its LED turned off (please refer "Output") and related H LEDs are turned on.

If all voltage (Phase-Neutral / Phase-Phase) are below the high set value (Hi) as a hysteresis voltage (U-H HyS), related output is switched on at the end of the "delay off time" (U-H oFd), its LED turned on (please refer "Output") and H LED is turned off.  
**Note:** High Voltage values are programmed for (Phase-Neutral / Phase-Phase) separately but "Hi HyS" (hysteresis) and "Hi onD" (delay on time) and "Hi oFd" (delay off time) values are common; these parameters have same values for Phase-Neutral / Phase-Phase.  
When Connection type (Star/Delta) is selected (refer to Connection menu), device will change the U-H L-1, U-H L-2 and U-H L-3 values automatically according to connection.

**Example:** If the connection type is selected as Star (with neutral); U-H HyS=10V U-H L-1=250V, U-H L-2=255V, U-H L-3=260V and then this connection type is selected as Delta (without neutral), device will change the values after calculated them according to Phase-Phase values.  
**New values:**  
U-H L-1 (L1-L2 Phase to phase voltage) = 433 V  
U-H L-2 (L2-L3 Phase to phase voltage) = 441 V  
U-H L-3 (L3-L1 Phase to phase voltage) = 450 V  
U-H HyS = 10 V.  
There are 6 submenus.  
U-H L-1, U-H L-2, U-H L-3, U-H HyS, U-H onD, U-H oFd.

# MULTIMETER EPM-04 / 04C / 04CS

In this menu, low set points for voltage values are programmed. Lo values for Phase-Neutral / Phase-Phase (according to Star / Delta selection) can be entered one by one.  
If all the voltage values (Phase-Neutral / Phase-Phase) are over the Lo value; related output is switched on, its LED turned on (please refer "Output") and related L LEDs are turned off.  
If any of the voltage values (Phase-Neutral / Phase-Phase) decrease the Lo value, L LED blinks and related output is switched off at the end of "delay on time" (U-L onD), its LED turned off (please refer "Output") and related L LED is turned on continuously.  
If all voltage (Phase-Neutral / Phase-Phase) values increase the low set value (Lo) as a hysteresis voltage (U-L HyS), related relay is switched on at the end of the "delay off time" (U-L oFd), its LED turned on (please refer "Output") and L LED is turned off.

**Note:** Low Voltage values are programmed for (Phase-Neutral / Phase-Phase) separately but "U-L HyS" (hysteresis), "U-L onD" (delay on time) and "U-L oFd" (delay off time) values are common; these parameters have same values for Phase-Neutral / Phase-Phase.  
When Connection type (Star/Delta) is selected (refer to Connection menu), device will change the U-L L-1, U-L L-2 and U-L L-3 values automatically according to connection.

**Example:** If the connection type is selected as Star (with neutral); U-L HyS=10V  
U-L L-1=180V, U-L L-2=175V, U-L L-3=170V and then this connection type is selected as Delta (without neutral), device will change the values after calculated them according to Phase-Phase values.  
**New values:**  
U-L L-1 (L1-L2 Phase to phase voltage) = 311 V  
U-L L-2 (L2-L3 Phase to phase voltage) = 303 V  
U-L L-3 (L3-L1 Phase to phase voltage) = 294 V  
U-L HyS = 10 V.  
There are 6 submenus.  
U-L L-1, U-L L-2, U-L L-3, U-L HyS, U-L onD, U-L oFd.

High value for L1, when the Star is selected; high value for L1-L2, when the Delta selected can be defined in this menu.  
0...300 for Star connection and 0...500 for Delta connection can be defined.  
If the value is set to zero (0), the high voltage warning is disabled. Refer "SP UoL Hi" for details.

**Note:** L2 and L3 phases can be programmed similarly.

Low value for L1, when the Star is selected; low value for L1-L2, when the Delta selected can be defined in this menu.  
0...300 for Star connection and 0...500 for Delta connection can be defined.  
If the value is set to zero (0), the high voltage warning is disabled. Refer "SP UoL Lo" for details.

**Note:** L2 and L3 phases can be programmed similarly.

(Refer to Page-4 for SP C<sub>Ur</sub> Hi, SP C<sub>Ur</sub> Lo, SP UoL Hi ve SP UoL Lo)

In this menu, required hysteresis voltage for high voltage warning is programmed, (same for Phase-Neutral/Phase-Phase.)  
0...200V for Star connection and 0...200V for Delta connection can be defined.  
Refer "SP UoL Hi" for details.

In this menu, required hysteresis voltage for low voltage warning is programmed, (same for Phase-Neutral/Phase-Phase.)  
0...200V for Star connection and 0...200V for Delta connection can be defined.  
Refer "SP UoL Lo" for details.

## Programming the "U-H HyS", "U-L HyS", "I-H HyS", "I-L HyS"

Press SET button for 3 sec. (trA Fo menu is displayed.)

Find "SP UoL t / SP C<sub>Ur</sub> rnt" menu by scrolling UP-DOWN buttons.

Press SET button (SP UoL Hi / SP C<sub>Ur</sub> Hi menu is displayed.)

Find [(SP UoL Hi / SP UoL Lo) / (SP C<sub>Ur</sub> Hi / SP C<sub>Ur</sub> Lo)] menu by scrolling UP-DOWN buttons.

Press SET button [(U-H L-1/U-L L-1) / (I-H L-1/I-L L-1) menu is displayed.]

Find [(U-H HyS / U-L HyS) / (I-H HyS / I-L HyS)] menu by scrolling UP-DOWN buttons.

Press SET button. Blinking the first digit of displayed value appears.

Enter the blinking digit value by scrolling UP/DOWN buttons. Switch to the other digits by using SET button, use ESC button to go to previous digit. After you entered the last digit press SET button. [(U-H HyS / U-L HyS) / (I-H HyS / I-L HyS)] is displayed. (Data is entered but is not activated yet. For activating the new data please follow the below steps).

Press ESC button one by one until "SAU E SET yES" is displayed.

Press SET button. When "SAU E SET yES" is displayed (if you press ESC button or choose "no" option instead of "yES" then new data will be cancelled and previous value will be activated).

"Delay on" time for activating the output for high voltage warning. It is common for all voltages (same for Phase-Neutral/Phase-Phase).  
The value can be programmed between 000.0 and 999.9 in terms of seconds. (Refer "SP UoL Hi" for details.)

"Delay on" time for activating the output for low voltage warning. It is common for all voltages (same for Phase-Neutral/Phase-Phase).  
The value can be programmed between 000.0 and 999.9 in terms of seconds. (Refer "SP UoL Lo" for details.)

"Delay off" time for activating the output for high voltage warning. It is common for all voltages (same for Phase-Neutral/Phase-Phase).  
The value can be programmed between 000.0 and 999.9 in terms of seconds. (Refer "SP UoL Hi" for details.)

"Delay off" time for activating the output for low voltage warning. It is common for all voltages (same for Phase-Neutral/Phase-Phase).  
The value can be programmed between 000.0 and 999.9 in terms of seconds. (Refer "SP UoL Lo" for details.)

## Programming the "U-H onD", "U-H oFd", "U-L onD", "U-L oFd", "I-H onD", "I-H oFd", "I-L onD", "I-L oFd"

Press SET button for 3 sec. (trA Fo menu is displayed.)

Find "SP UoL t / SP C<sub>Ur</sub> rnt" menu by scrolling UP-DOWN buttons.

Press SET button (SP UoL Hi / SP C<sub>Ur</sub> Hi menu is displayed.)

Find [(SP UoL Hi / SP UoL Lo) / (SP C<sub>Ur</sub> Hi / SP C<sub>Ur</sub> Lo)] menu by scrolling UP-DOWN buttons.

Press SET button [(U-H L-1 / U-L L-1) / (I-H L-1 / I-L L-1) menu is displayed.]

Find [(U-H onD / U-H oFd) / (U-L onD / U-L oFd)] / [(I-H onD / I-H oFd) / (I-L onD / I-L oFd)] menu by scrolling UP-DOWN buttons.