

# MULTIMETER EPM-06 / 06C / 06CS

## Dimensions

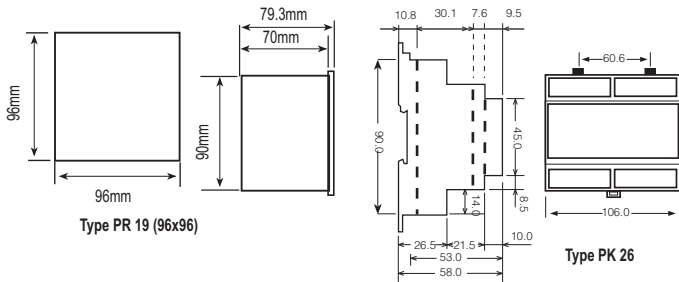

## Panel Cut-out

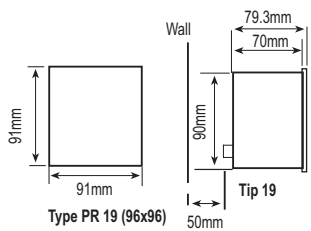

## Connection Diagram

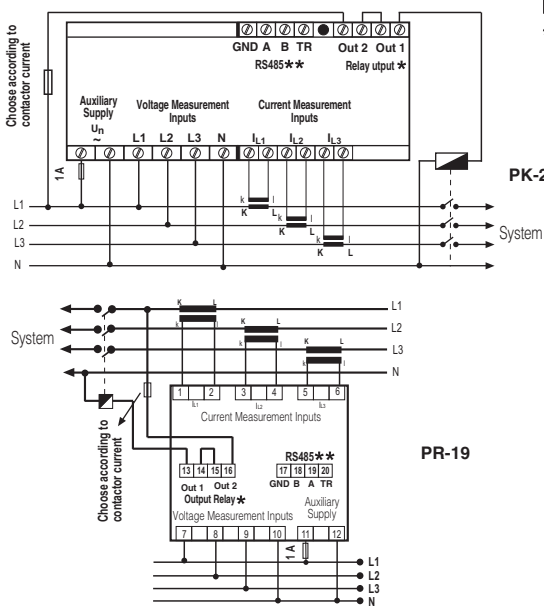

\* Available only for EPM-06C/06CS  
\*\* Available only for EPM-06CS

Note: For CT-25 models:  
k: When CT-25 is used, Red cable is connected to k terminal.  
l: When CT-25 is used, Black cable is connected to l terminal.

## Summary of the Contact Operations \*

	ALTERNATIVE 1 (U-I)	ALTERNATIVE 2 (H-L)
Out 1	Current --> Under/Over	Voltage --> Under Frequency --> Under Current --> Under Phase Seq.
Out 2	Voltage --> Under/Over Frequency --> Under/Over Phase Seq.	Voltage --> Over Frequency --> Over Current --> Over

\* Valid for EPM-06C/06CS

# MULTIMETER EPM-06 / 06C / 06CS

## INDEX

- Precautions for Installation and Safe Usage.....1
- Front Panel and Usage of Buttons.....1
- General Information and Applications.....1
- Using the Buttons.....2
- Transformer Menu (Ct / trn / Utr / ConnEctIon).....2
- User Password Settings (Pin Menu).....2
- Activating the User Password (Pin Act Menu).....2
- Changing the User Password (Pin CHg Menu).....2
- Output Setting Menu.....3
- Current Setting Menu (SP Current Menu).....3
- High/Low Current Settings (SP Cur Hi, SP Cur Lo Menu).....3
- Hysteresis Settings for High/Low Currents (CtR Hi Hys, CtR Lo Hys Menu).....3
- Delay-on Time for High/Low Currents (Hi on dEL, Lo on dEL Menu).....3
- Delay-off Time for High/Low Currents (Hi oFF dEL, Lo oFF dEL Menu).....3
- Start and Auto Function (StArT dEL and Auto rSt Menu).....4
- Instant Trip Function (CtR inSt rP Menu).....4
- Voltage Setpoint Menu (SP Volt Menu).....4
- High/Low Voltage Settings (SP UoL Hi, SP UoL Lo Menu).....4
- Hysteresis Settings for High/Low Voltages (UoL Hi Hys, UoL Lo Hys Menu).....4
- Delay-on Time for High/Low Voltages (Hi on dEL, Lo on dEL Menu).....5
- Delay-off Time for High/Low Voltages (Hi oFF dEL, Lo oFF dEL Menu).....5
- Frequency Menu.....6
- High/Low Frequency Settings (Frq Hi, Frq Lo Menu).....6
- Hysteresis Settings for High/Low Frequencies (Frq Hi Hys, Frq Lo Hys).....6
- Delay-on / Delay-off Time for High/Low Frequencies (Frq on dEL, Frq oFF dEL).....6
- Phase Sequence (Voltage Sequence Menu) and Instant Trip (UoL inSt rP Menu) Menu.....6
- Erasing the Max., Min. and Max. Demand Values (Reset Menu).....6
- Demand Time for Demand and Max. Demand (dE tM Menu).....7
- Communication Menu (RS-485).....7
- Technical Features and Default Factory Settings.....7
- Connection Diagram.....8

**Output, SP Current and SP Volt menus are available for EPM-06C/06CS; RS-485 menu is available for EPM-06CS.**

## PRECAUTIONS FOR INSTALLATION AND SAFE USE

- In CT-25 (120A) compliant models, only CT-25 current transformer must be used.**
- Other type of CT's have a high risk to damage to device.**
- Failure to follow those instructions will result in death or serious injury.**
- Disconnect all power before working on equipment.**
- When the device is connected to the network, do not remove the front panel.**
- Do not try to clean the device with solvent or the like. Only clean with dry cloth.**
- Verify correct terminal connections when wiring.**
- Electrical equipment should be serviced only by your component seller.**
- Only for rack panel mounting.**
- Fuse must be F type and limit value doesn't exceed 1A.**
- No responsibility is assured by the manufacturer or any of its subsidiaries for any consequences arising out of the use of this material.**

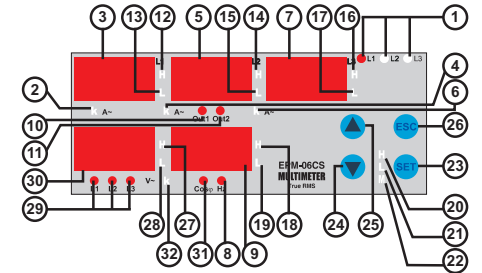

- 1 ..... Phase LEDs. The LEDs turn on when the voltage value, which is applied to one of the current inputs, reach 30 V
- 2 ..... First display's k LED (for L1). Measurement parameter is the unit of kilo when LED is turned on. ie: kA, kV
- 3 ..... Display for L1.
- 4 ..... Second display's k LED (for L2 and neutral current). Measurement parameter is the unit of kilo when LED is turned on. ie: kA, kV
- 5 ..... Display for L2 and neutral current.
- 6 ..... Third display's k LED (for L3). Measurement parameter is the unit of kilo when LED is turned on. ie: kA, kV
- 7 ..... Display for L3.
- 8 ..... Displays network frequency when Hz LED is turned on.
- 9 ..... Display for frequency and Cosφ (for EPM-06C/06CS).
- 10 ..... First warning output LED (Out1). Turned on when the output is activated.
- 11 ..... Second warning output LED (Out2). Turned on when the output is activated.
- 12 ..... Over current / voltage warning output for L1. (EPM-06C/06CS)
- 13 ..... Low current / voltage warning output for L1. (EPM-06C/06CS)
- 14 ..... Over current / voltage warning output for L2. (EPM-06C/06CS)
- 15 ..... Low current / voltage warning output for L2. (EPM-06C/06CS)
- 16 ..... Over current / voltage warning output for L3. (EPM-06C/06CS)
- 17 ..... Low current / voltage warning output for L3. (EPM-06C/06CS)
- 18 ..... Over current / frequency warning output for frequency. (EPM-06C/06CS).
- 19 ..... Low current / frequency warning output for frequency. (EPM-06C/06CS).
- 20 ..... H LED for max. instant current and voltage. Max. instant currents and voltages are displayed when this LED is turned on.
- 21 ..... L LED for min. instant current and voltage. Min. instant currents and voltages are displayed when this LED is turned on.
- 22 ..... M LED for max. demand. Max. demand values are displayed when this LED is turned on.
- 23 ..... SET button. It is used to enter into the menu and to save the values. If SET button is pressed for 3 sec. in the measurement mode, you can enter into menus. This button is used for monitoring the max. (H), Min. (L) current values and max. demand values in measurement mode.
- 24 ..... Downward selection button. And also switching between the phases for EPM-06C/06CS.
- 25 ..... Upward selection button. And also switching between the phases for EPM-06C/06CS.
- 26 ..... ESC button. Displaying the neutral current during the measurement mode. Escaping from the menu. And also used for switching off the Latch function while this function has activated.
- 27 ..... Over voltage warning LED which is displayed in fourth display.
- 28 ..... Low voltage warning LED which is displayed in fourth display.
- 29 ..... These LEDs are used for which phase refers to measurement of voltage in 4th display.
- 30 ..... Display for monitoring the phase voltages (According to related phase).
- 31 ..... This LED; indicates Cosφ when L1, L2 or L3 activated for monitoring voltage values in 4th display. Indicates average value of **inductive Cosφ** when L1-L2 are activated. Indicates average value of **capacitive Cosφ** when L2-L3 are activated.
- 32 ..... k LED for monitored phase in 4th display.

## General information

EPM-06/06C/06CS is designed for measuring the below parameters in a 3-Phase system. Phase current, frequency, neutral current and voltages (Phase-Phase and Phase-Neutral).  
EPM-06C/06CS;  
Device has 2 warning output which named as Out1 and Out2. (NO-Normally Open)  
Please refer to "Output" menu for the functions of the relays.

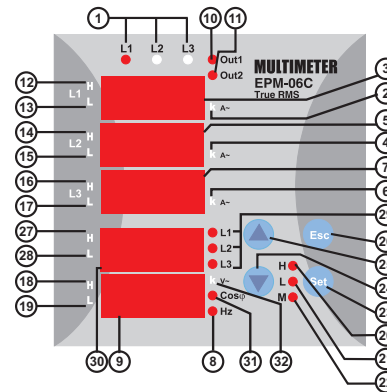

# MULTIMETER EPM-06 / 06C / 06CS

## Below measurement and application can be implemented with EPM-06/06C/06CS:

- 1) Phase currents (IL), Neutral current (IN), frequency and Cosφ (EPM-06C/06CS); Phase-Phase and Phase-Neutral voltages can be measured.
- 2) Existence of live phases can be observed by L1-L2-L3 LEDs on the device.
- 3) Min. and max. values for measured currents and voltages can be monitored with only one button.
- 4) Max. demand values for measured current can be monitored, demand time can be defined in "dE t" menu.
- 5) A 4 digit password can be defined from pin menu in order to prevent the change of settings by unauthorized person.
- 6) Current transformer ratio is programmable. (1....2000)  
Current transformer ratio can be programmed in term of "turn number" between 1....20 (for CT-25 adapted devices).  
Voltage transformer ratio is programmable. (0.1 .... 4000)
- 7) A user defined measurement range is used for monitoring the voltages and currents; and Out 1 & Out2 outputs are used for warning the user and disconnecting the device in case of exceeding the limits of measurement range.
- 8) In case of using the device for measuring the current values of motors etc., start delay (Auto On) protection can be used for preventing the equipment against the improper tripping, which is because of the demurrage current.
- 9) When a failure has occurred use the Latch function, in order to keep the device with saving its position (Latched), even if the failure conditions are removed.

## 7th, 8th and 9th subjects are valid for EPM-06C/06CS.

### Using the Buttons:

Some buttons and button groups are used for the below special function when device is in the measurement mode (Without selecting a menu).

- ▲ Switching between the phase-phase voltages in fourth display. Used for changing the menu settings and parameters in programming mode.
- ▼ Used for monitoring min. / max. currents and voltages or max. demand values. Switching to the programming mode if it pressed for 3 sec. In programming mode; it is used for switching to the menu and saving changes for the parameters.
- ◀ Switching between neutral current and phase current in measurement mode. Switching to the previous menu and escaping the programming menu without saving the changes.  
If the Latch function is turned on (EPM-06C/06CS); output will be released when current(s) of system is exceed the defined values. When the system's current turns back to normal values then output doesn't react. Output can be triggered by the "ESC" button.

### Commissioning and menu setting (for EPM-06/06C/06CS)

Energize the device after implementing the connections respected to the user manual.  
Enter the proper menu settings in order to correct measurements and applications.

#### Current Transformer Ratio Setup:

In this menu, current transformer ratio is set between 1 - 2000. (This menu is not available in the devices which are adapted with CT-25.)  
**Note:** If the current transformer is not used between the system and device, current transformer ratio is entered as '1'.  
**Example:** If a current transformer which has a ratio of 30/5A is used between the system and device;  
Current transformer ratio is entered as = 30/5 = 6.

Press SET button for 3 sec. (trA Fo menu is displayed)

Press SET button: trA Fo Ctr menu is displayed (In CT-25 adapted devices, trA Fo Utr or Con nEC to n menu can be displayed by scrolling the UP/DOWN buttons.)

Press SET button. Blinking the first digit of displayed value appears.

Enter the blinking digit value by scrolling UP/DOWN buttons. Switch to the other digits by using SET button, use ESC button to go to previous digit. After you entered the last digit press SET button. trA Fo Ctr is displayed. (Data is entered but is not activated yet. For activating the new data please follow the below steps).

Press ESC button one by one until "SAU E SET yES" is displayed.

Press SET button. When "SAU E SET yES" is displayed (If you press ESC button or choose "no" option instead of "yES" then new data will be cancelled and previous value will be activated).

#### Programming the Turn Number:

This menu is available for CT-25 adapted devices. User defines the turn number, which is the number of how many tour the current cable has rounded into the CT-25. Numbers can be selected between 1-20. Greater the number of turn means greater the sensitivity.

trn	1	2	3	4	5	6	7	8	9	10	11	12	13	14	15	16	17	18	19	20
min	0.00	0.00	0.00	0.00	0.00	0.00	0.00	0.00	0.00	0.00	0.00	0.00	0.00	0.00	0.00	0.00	0.00	0.00	0.00	0.00
max	0.00	0.00	0.00	0.00	0.00	0.00	0.00	0.00	0.00	0.00	0.00	0.00	0.00	0.00	0.00	0.00	0.00	0.00	0.00	0.00

#### Voltage Transformer Ratio:

In this menu, voltage transformer ratio is set between 0000,1 - 4000,0.  
**Note:** If the voltage transformer is not used between the system and EPM-06, voltage transformer ratio is entered as '1'.  
**Example:** If a voltage transformer which has a ratio of 34.5KV/100V is used between the system and device; Voltage transformer ratio is entered as 345. (34500/100)

#### Selecting the Connection Type :

Connection can be selected as Star or Delta in this menu.  
Phase-Neutral voltage monitoring can be implemented if the "Star" connection is selected.

Phase-Phase voltage monitoring can be implemented if the "Delta" connection is selected.

**NOTE: When the "Delta" connection is selected, "neutral current monitoring" can not be implemented even if it is activated and displaying function of ESC button will be disabled also.**

#### User Password Setup:

In this menu user password is defined and activated.  
You must define and activate a 4 digit user password for preventing device settings from the illegal usage.  
There are 2 sub menu in the Pin menu.

#### Activating the user password :

This menu is used for activating the user password.  
After the user password is activated for entering to the menus; if the ▲ button is pressed for 3 sec., while the instant values are observed, user password is required. If the user password is entered wrong device does not latch.  
**Note:** Factory default value of user password is "0000"

To activate the user password; in measurement mode Press SET button for 3 sec. (trA Fo menu is displayed)

Find the "Pin" menu by scrolling UP/DOWN buttons.

Press SET button (Pin Act IUA IE is displayed.)

Press SET button. Blinking the first digit of displayed value appears.

Enter the blinking digit value by scrolling UP/DOWN buttons. Switch to the other digits by using SET button, use ESC button to go to previous digit. After you entered the last digit press SET button. "Pin Act IUA IE" is displayed. "on" can be selected by scrolling UP/DOWN buttons. (Data is entered but is not activated yet. For activating the new data please follow the below steps).

Press ESC button one by one until "SAU E SET yES" is displayed.

Press SET button. When "SAU E SET yES" is displayed (If you press ESC button or choose "no" option instead of "yES" then new data will be cancelled and previous value will be activated).

#### Changing of User Password:

This menu is used for changing the user password.  
**Note:** Factory default value for user password is "0000"

To change the user password; in measurement mode Press SET button for 3 sec. (trA Fo menu is displayed)

Find the "Pin" menu by scrolling UP/DOWN buttons.

Press SET button (Pin Act IUA IE is displayed.)

Find the "Pin CHA n9E" menu by scrolling UP/DOWN buttons.

# MULTIMETER EPM-06 / 06C / 06CS

Press ESC button one by one until "SAU E SET yES" is displayed.

Press SET button. When "SAU E SET yES" is displayed (If you press ESC button or choose "no" option instead of "yES" then new data will be cancelled and previous value will be activated).

#### Serial Communication (for EPM-06CS)

EPM-06CS has MODBUS RTU communication protocol which is optical isolated. All measured parameters can be transfer to the computer. Transformer ratios and communication parameters can be set. Saved values can be reset.

Programmed parameter for communication explained below.

Press SET button 3 sec. (trA Fo menu is displayed.)

Find RS-485 menu by scrolling UP/DOWN buttons.

Press SET button (Adr ESS menu is displayed.)

Find "Adr ESS / bAU d / PAnTy" menu by scrolling UP/DOWN buttons.

Press SET button ("001 / 9600 / no" menu is displayed.)

Enter the parameter values by scrolling UP/DOWN buttons (001...247 / 2400...38400 / no, EUE, odd).

Press SET button. "Adr ESS / bAU d / PAnTy" is displayed. (Data is entered but is not activated yet. For activating the new data please follow the below steps)

Press ESC button one by one until "SAU E SET yES" is displayed.

Press SET button. When "SAU E SET yES" is displayed (If you press ESC button or choose "no" option instead of "yES" then new data will be cancelled and previous value will be activated).

#### MODBUS RTU PROTOCOL (Available only for EPM-06CS)

Standard MODBUS RTU message is shown below.

T	ADDRESS 8 BIT	FUNCTION 8 BIT	DATA N X 8 BIT	CRCH	CRCL	T
---	---------------	----------------	----------------	------	------	---

The T times corresponds to a time in which data must not be exchanged on the communication bus to allow the connected devices to recognize the end of one message and the beginning of another. This time must be at least 3.5 characters at the selected baud rate. Address range (1-247) is address of the connected device. The data field contains data sent to the slave by master or data sent to master by slave.  
CRC is a error check method by using MODBUS RTU protocol and consists of 2 bytes.

#### Available Modbus Function:

03H	READ HOLD REGISTERS
04H	PRESET SINGLE REGISTER
10H	PRESET MULTIPLE REGISTERS

Read Hold (03) function is used for reading measured values and set value. If any request of reading of a register, excepted mentioned in register table, device will send an error message.  
For example to read phase1 voltage by sending a message to the device.

01 03 00 00 00 02 XX XX  
01 Device address  
03 Function  
00 MSB address  
00 LSB address  
00 Register number MSB  
02 Register number LSB  
XX CRC MSB  
XX CRC LSB  
Preset Single Register (06) function is used for writing the setting values, erasing the energy counter or resetting the min., max., demand values. Current transformer ratio can be set 0-2000, voltage transformer ratio can be set 1-4000.  
i.e. Setting CT as 100;  
01 06 80 02 00 64 XX XX  
01 Device address  
06 Function  
80 MSB address  
02 LSB address  
00 Data MSB  
64 Data LSB  
XX CRC MSB  
XX CRC LSB

Preset Multiple Register (10H) is used to set more than one register at same time.  
i.e. Setting CT as 100, UI as 20.0;  
01 10 80 00 00 02 04 00 C8 00 64 XX XX  
01 Device Address  
10 Function  
80 MSB address  
00 LSB address  
00 Register number MSB  
02 Register number LSB  
04 Byte count  
00 Data MSB  
C8 Data LSB  
00 Data MSB  
64 Data LSB  
XX CRC MSB  
XX CRC LSB

## EPM-06CS COMPUTER CONNECTION

31 DEVICES CAN BE CONNECTED AT THE SAME LINE

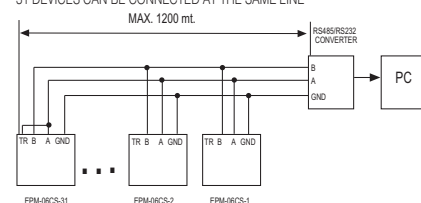

MAX. 247 DEVICES CAN BE CONNECTED AT SAME LINE BY USING REPEATER.

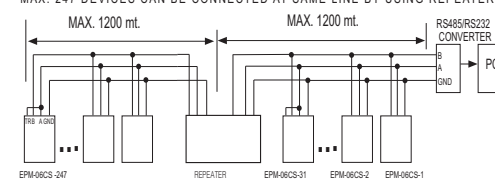

#### Technical Features

Rated Voltage (Un)	: Please look at back side of the device.
Operating frequency (f)	: 45-65 Hz
Auxiliary Supply Power Consumption	: < 4 VA
Measuring Input Power Consumption	: < 1 VA
Measurement range	
Current	: 0.05-5.5A~
Voltage	: 2 - 120 V~ for CT-25
Class	: 10-300 V AC (Phase - Neutral)
Current Transformer Ratio	: 10-500 V AC (Phase - Phase)
Turn number for CT-25 adapted models:	: 1...2000
Voltage Transformer Ratio	: ±1% digit (10%-100% x full scale)
Max. Ctr x Vtr	: 40,000
Communications (for EPM-06CS)	: MODBUS RTU (RS 485)

Baud Rate (for EPM-06CS)	: Optic isolated, programmable
Address (for EPM-06CS)	: 2400-38400 bps
Parity (for EPM-06CS)	: 1-247
No. Odd, Even, 8 Data Bits, 2 Stop Bits	: No, Odd, Even, 8 Data Bits, 2 Stop Bits
Output Relays (for EPM-06C/06CS)	: 2 NO, 5A 1250 VA
Ambient Temperature	: -5°C ~ +50°C
Display	: Red LED display
Dimensions	: PR-19, PK-26
Equipment Protection Class	: Double Insulation - Class II (II)
Box Protection Class	: IP 40
Terminal Protection Class	: IP 00
Box Material	: Nonflammable
Mounting	: Panel Mounted (PR-19)
Wire Crosssection (for terminals)	: Rail Mounted (PK-26)
Weight	: 2.5 mm²
0.56 kg (PR-19)	
0.52 kg (PK-26)	
Mounting Category	: Class III
Panel Size	: 91x91 mm (PR-19)
	: 46x107 mm (PK-26)

#### Default Settings

UJ type	UJ type	UJ type	UJ type
ctr - 0001	Cur Hi L-1 - 5.000	Cur Lo L-2 - 0.000	Out relay - U-I
Utr - 0001	Cur Hi L-2 - 5.000	Cur Lo L-3 - 0.000	Latch - off
trn - 01	Cur Hi L-3 - 5.000	Cur Lo L-n - 0.000	Out Inverse - off
ConnEC - Star	Cur Hi L-n - 5.000	Cur Lo HYS - 0.200	
Pin Act - of	Cur Hi HYS - 0.100	Lo on dEL - 010.0	bAUd - 9600
Pin - 0000	Hi on dEL - 010.0	Lo off dEL - 010.0	AdRES - 001
	Hi off dEL - 003.0	Str Art dEL - 0.000	PArTy - no
	Cur Lo L-1 - 0.000	Auto reset - off	
		Cur ins trp - off	
UoL Hi L-1 - 250	UoL Lo L-3 - 180	Frq Hi - 63	
UoL Hi L-2 - 250	UoL Lo HYS - 010.0	Frq Hi HYS - 01.00	
UoL Hi L-3 - 250	Lo on dEL - 003.0	Frq Lo - 47	
UoL Hi HYS - 10	Lo off dEL - 003.0	Frq Lo HYS - 01.00	
Hi on dEL - 003.0	UoL pHs SEQ - off	Frq on dEL - 003.0	
Hi off dEL - 003.0	UoL ins trP - off	Frq off dEL - 003.0	
UoL Lo L-1 - 180			
UoL Lo L-2 - 180			

#### CT-25 type

Cur Hi L-1 - 100.0	Cur Lo L-2 - 0.000
Cur Hi L-2 - 100.0	Cur Lo L-3 - 0.000
Cur Hi L-3 - 100.0	Cur Lo L-n - 0.000
Cur Hi L-n - 100.0	Cur Lo HYS - 2.000
Cur Hi HYS - 2.000	Lo on dEL - 010.0
Hi on dEL - 010.0	Lo off dEL - 010.0
Hi off dEL - 010.0	Str Art dEL - 0.000
Cur Lo L-1 - 0.000	Auto reset - off
	Cur ins trp - off

# MULTIMETER EPM-06 / 06C / 06CS

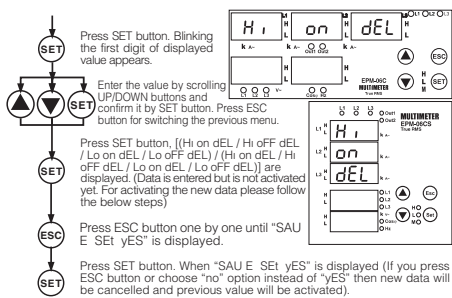

## Setpoints for Frequency :

In this menu, Frequency range can be defined according to High and Low values of Frequency measurement.

If the frequency of the system decreases the Frq Hi value; output is switched **on** and LED is turned **on**. (Refer to Output menu) and H LED for frequency is turned **off**.

If the frequency of the system exceeds the high set value, H LED relating to frequency blinks, output switched **off** at the end of defined time (Frq on dEL), LED turned **off** (Refer to Output menu) and H LED for frequency is turned **on** continuously.

If the frequency of the system is under the high set value (Frq Hi) as a hysteresis (Frq Hi HyS), output is turned **on** at the end of defined time (Frq off dEL), LED is turned **on** and H LED is turned **off**. At the end of the adjusted time (Frq off dEL), output1 LED turns **on** and H LEDs turn **off**.

If the frequency of the system is over the low set value (Frq Lo), output is turned **on**, LED is turned **on** and L LED is turned **off**.

If the frequency of the system decreases the low set value (Frq Lo), L LED blinks; output is turned **off** at the end of defined time (Frq on dEL), LED is turned **off** and L LED is turned **on** continuously.

If the frequency of the system is over the low set value (Frq Lo HyS) as a hysteresis (Frq HyS), output is turned **on** at the end of defined time (Frq off dEL), LED is turned **on** and L LED is turned **off**.

**Note:** System frequency is measured for L1.

There are 6 submenus.

Frq Hi, Frq Lo, Frq Hi HyS, Frq Lo HyS, Frq on dEL, Frq off dEL.

Max. value for system frequency, this value can be defined between 0...70.00 Hz. If the value is set to zero (0), the high frequency warning is disabled.

Min. value for system frequency, this value can be defined between 0...70.00 Hz. If the value is set to zero (0), the low frequency warning is disabled.

**Note:** Attention for common using of output and relay LED for voltage.

In this menu, required hysteresis value can be defined between 0...20.00 Hz. In order to switching **off** the "high frequency" warning.

In this menu, required hysteresis value can be defined between 0...20.00 Hz. In order to switching **off** the "low frequency" warning.

Delay-on time for activation of alarm for high and low frequency value.

This value can be defined between 000.0...999.9 in term of second..

Delay-off time for disactivation of alarm for high and low frequency value.

This value can be defined between 000.0...999.9 in term of second..

Phase sequence can be turned **on/off** in this menu. Inversed phase voltage which is applied to the measurement inputs (L1-L2-L3), can be monitored. Default setting is **off**. In order to let the device to warn user in case of inversed phase situation please change the **off** position as **on** in "UoL PHS SEQ" menu. Phase sequence function is disabled if the selection is selected **off**.

L1, L2 and L3 LEDs blink and output output released immediately when "UoL PHS SEQ" is turned **on** and phase sequence is inverted with any reason.

**Note:** Output 2 is used if U-I is selected and Output1 is used if H-L is selected in Output menu for the Phase Sequence monitoring.

**Instant Tripping Function.**  
At position **ON**, if any **V-L-L / V-L-N** values exceeds 1.5 times of high voltages (UoL Hi L-1/L-2/L-3) values; the "voltage output" switches **OFF** instantly, output LED turned **OFF** and H LED, for related voltage, is turned **ON**. (Please refer to "Output".)

If any phase voltage decrease 0.5 times low voltages (UoL L-1/L-2/L-3); the "voltage output" switches **OFF** instantly, output LED turned **OFF** and Lo LED, for related voltage, is turned **ON**.

(Refer to Page-4 for "Cür inS trP", "Aut orSt" and "UoL inS trP")

**rES Et**

**Reset function.**  
In this menu, values of min., max., max. demand are erased. It saves the instantaneously measured min. and max. values of the device into its memory. Please kindly look at to the section of **functions of buttons** for min. and max. values.

**Note:** Measured electrical parameters which are saved to the memory are not affected from the electric interruptions. In the rES Et HL or rES Et dE menu; when you choose yES and quit from all menus, if you define the changes, min., max. and max. demand values of all parameters are erased at the same time.

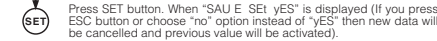
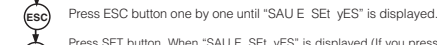
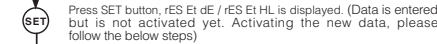
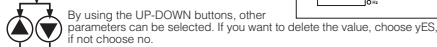
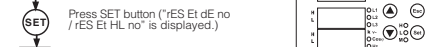
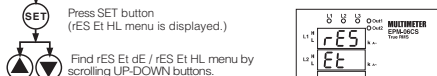

**dE t**

**Demand Time.**  
Max. Demand time can be defined between 01-60 minute in this menu.

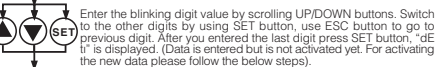

# MULTIMETER EPM-06 / 06C / 06CS

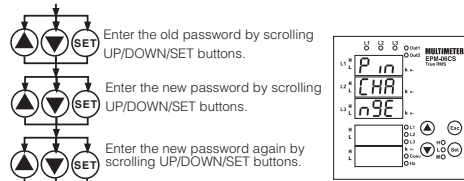

Press SET button, "P in CHA n9E" is displayed. (Data is entered but is not activated yet. For activating the new data please follow the below steps)

Press ESC button one by one until "SAU E SET YES" is displayed.

Press SET button. When "SAU E SET YES" is displayed (If you press ESC button or choose "no" option instead of "YES" then new data will be cancelled and previous value will be activated).

## Output menu (only for EPM-06C/06CS) :

In this menu, using of oUt Pnt function is explained with details below.

## Out Relay function:

In this menu high-low or voltage-current monitoring is determined for Out1 and Out2 outputs.

**Note:** When **U-I** (voltage-current) is selected; Out2 is monitoring according to high or low voltage, frequency values and phase sequence, Out1 is monitoring according to high or low current value.

When **H-L** (high-low) is selected; Out2 is monitoring according to high values for voltage, frequency and low-current, Out1 is monitoring according to low values for voltage or current.

Please refer to page 8 for a summary of the contact operations.

## Out Latch function:

If the Latch function is turned **on**, OUT1-OUT2 outputs, which are released when a failure has occurred, keep remained at its position even if the failure is over. Press **ESC** in order to triggering the relay when the failure situation is removed.

If the Latch function is turned **off**, Released outputs triggered at the end of delay off time when the failure situation is removed.

## Out inverse function:

If "oUt inU ErS" function is selected **off**, Device is started with closed output contacts (out1, out2) in the normal network conditions according to settings.

Otherwise devices started with open position of the contacts. Default setting is "off".

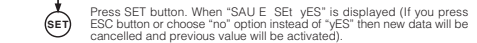
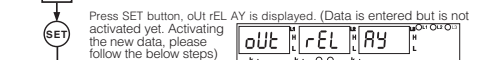
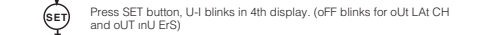

## Programming "SP Cür rnt" :

Using purposes of submenus of "SP Cür rnt" explained below with details.

**△ In case of using the device for measuring the current values of motors etc., start delay (Auto rSt) function can be used for preventing the equipment against the improper tripping, which is because of the demurrage current. If the system current decreases 50mAxCtr then start-up delay is resetted and related output detect the system automatically. This feature must be observed in case of using this function.**

**SP Cür H**  
In this menu, high set points for current values are programmed. Hi values for IL1, IL2, IL3 and IN can be entered one by one. If all the current values are under the Hi value; Output1 output is switched on, LED of Output1 turned on and LED of H turned **off**.

If any current (IL1, IL2, IL3 and IN) exceeds the high set value, H LED blinks. Output1 output switches off at the end of the defined time (Hi on dEL), Output1 LED turned **off** and H LED turned **on** continuously.

If all currents (IL1, IL2, IL3 and IN) are below the high set value (Hi) as a hysteresis current (Cür Hi HyS), output1 output switches on at the end of the defined time (Hi off dEL), output1 LED turned **on** and H LED turned **off**.

This menu has 7 sub menus. Cür Hi L-1, Cür Hi L-2, Cür Hi L-3, Cür Hi L-n, Cür Hi HyS, Hi on dEL, Hi off dEL.

**Note:** High Current values are programmed for IL1, IL2, IL3 and IN separately but Cür Hi HyS (hysteresis), Hi on dEL (delay on time) and Hi off dEL (delay off time) values are common and they have same values for IL1, IL2, IL3 and IN.

**SP Cür Lo**  
In this menu, low set points for current values are programmed. Lo values for IL1, IL2, IL3 and IN can be entered one by one. If all the current values are over the Lo value; Output1 output is switched on, LED of Output1 turned on and LED of L turned **off**.

If any current (IL1, IL2, IL3 and IN) exceeds the low set value, L LED blinks and Output1 output switches off at the end of the defined time (Lo on dEL), Output1 LED turned **off** and L LED turned **on** continuously.

If all currents (IL1, IL2, IL3 and IN) are over the low set value (Lo) as a hysteresis current (Cür Lo HyS), output1 output switches on at the end of the defined time (Lo off dEL), output1 LED turned **on** and L LED turned **off**.

This menu has 7 sub menus. Cür Lo L-1, Cür Lo L-2, Cür Lo L-3, Cür Lo L-n, Cür Lo HyS, Lo on dEL, Lo off dEL.

**Note:** Low Current values are programmed for IL1, IL2, IL3 and IN separately but Cür Lo HyS (hysteresis), Lo on dEL (delay on time) and Lo off dEL (delay off time) values are common and they have same values for IL1, IL2, IL3 and IN.

**Cür L1**  
In this menu, max. current value for L1 is programmed. The current value can be programmed between; 0.001...5.000 A (Cr = 1); 0.001...120.0 A (for CT-25 adapted device trm=1).

If the value is set to zero (0), the high current warning is disabled (Cür Hi L-2 and Cür Hi L-3 are programmed similarly). Refer "SP Cür Hi" for details.

**Cür L2**  
In this menu, min. current value for L1 is programmed. The current value can be programmed between; 0.001...5.000 A (Cr = 1); 0.001...120.0 A (for CT-25 adapted device trm=1).

If the value is set to zero (0), the low current warning is disabled (Cür Lo L-2 and Cür Lo L-3 are programmed similarly). Refer "SP Cür Lo" for details.

**Cür HYS**  
In this menu, required hysteresis current for high current warning is programmed. (same for IL1, IL2, IL3 and IN). The current value can be programmed between; 0.001...2.500 A (Cr = 1); 0.001...60.00 A (for CT-25 adapted device trm=1).

Refer "SP Cür Hi" for details.

**Cür Lo**  
In this menu, required hysteresis current for low current warning is programmed. (same for IL1, IL2, IL3 and IN).

The current value can be programmed between; 0.001...2.500 A (Cr = 1); 0.001...60.00 A (for CT-25 adapted device trm=1).

Refer "SP Cür Lo" for details.

**Hi on dEL**  
Delay time for activating the output for high current warning. It is common for all currents (IL1, IL2, IL3 and IN).

The value can be programmed between 000.0 and 999.9 in terms of seconds. (Refer "SP Cür Hi" for details.)

**Lo on dEL**  
Delay time for activating the output for low current warning. It is common for all currents (IL1, IL2, IL3 and IN).

The value can be programmed between 000.0 and 999.9 in terms of seconds. (Refer "SP Cür Lo" for details.)

**Hi off dEL**  
Delay time for releasing the output for high current warning. It is common for all currents (IL1, IL2, IL3 and IN).

The value can be programmed between 000.0 and 999.9 in terms of seconds. (Refer "SP Cür Hi" for details.)

**Lo off dEL**  
Delay time for releasing the output for low current warning. It is common for all currents (IL1, IL2, IL3 and IN).

The value can be programmed between 000.0 and 999.9 in terms of seconds. (Refer "SP Cür Lo" for details.)

(Refer to Page-5)



# MULTIMETER EPM-06 / 06C / 06CS

## Programming the "SP CŪr Hi", "SP CŪr Lo", "SP UoL Hi" and "SP UoL Lo".

Press SET button for 3 sec. (trA Fo menu is displayed.)

Find "SP CŪr rnt / SP UoL t" menu by scrolling UP-DOWN buttons.

Press SET button. "SP CŪr Hi / SP UoL Hi" menu is displayed.

Find [(SP CŪr Hi/SP CŪr Lo) / (SP UoL Hi/SP UoL Lo)] menu by scrolling UP-DOWN buttons.

Press SET button [(CŪr Hi L-1/CŪr Lo L-1) / (UoL Hi L-1/UoL Lo L-1) menu is displayed.]

Press SET button. Blinking the first digit of displayed value appears.

Enter the blinking digit value by scrolling UP/DOWN buttons. Switch to the other digits by using SET button, use ESC button to go to previous digit. After you entered the last digit press SET button. "CŪr Hi L-1/CŪr Lo L-1" / (UoL Hi L-1/UoL Lo L-1" is displayed. (Data is entered but is not activated yet. For activating the new data please follow the below steps).

Press ESC button one by one until "SAU E SET yES" is displayed.

Press SET button. When "SAU E SET yES" is displayed (if you press ESC button or choose "no" option instead of "yES" then new data will be cancelled and previous value will be activated).

**Start-up delay:**  
Start Delay Time is used to prevent from faulty switchings caused by motor start-up current (demurrage current).  
When Out1 remain switched ON in this time period (even if the current value exceeds the limits device doesn't sense it as a warning. The device doesn't give a warning even if the current value isn't in the setting interval. This function is used with "Auto Reset" function.

**Auto Reset Function:**  
If **Auto Reset** function is selected as ON; Each time that the current decreases "50mAxCtr" value, start-up delay time is reset and when the current value increases "50mAxCtr", start-up delay function is activated.  
If **Auto Reset** function is selected as OFF; if the power supply is switched off and then switched on, start-up delay function is activated.

**Auto Reset Function:**  
If **Auto Reset** function is selected as ON; Each time that the current decreases "50mAxCtr" value, start-up delay time is reset and when the current value increases "50mAxCtr", start-up delay function is activated.  
If **Auto Reset** function is selected as OFF; if the power supply is switched off and then switched on, start-up delay function is activated.

### Please refer to below graphics for the operating principle of STA rt dEL and Aut o rSt functions

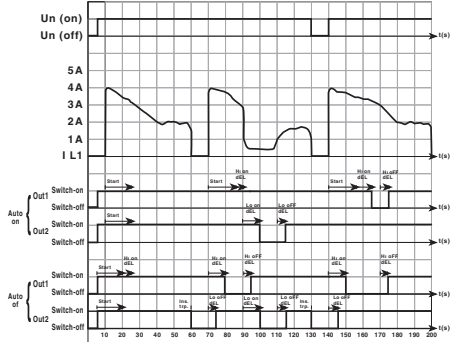

**Instant Tripping Function.**  
At position ON, if any phase current (IL1, IL2, IL3 and IN) exceeds 1.5 times of high (CŪr Hi L-1, L-2, L-3, L-n) values, the "current output" switches off instantly, output LED turned off and H LEDs for related currents turned on. (Please refer to "Output").  
At position OFF, if any phase current (IL1, IL2, IL3 and IN) decrease 0.5 times of low (CŪr Lo L-1, L-2, L-3, L-n) values, the "current output" switches off instantly, output LED turned off and L LEDs for related currents turned on. (Please refer to "Output").  
At position OFF, instant tripping function is cancelled.

## Programming "CŪr inS trP", "Aut o rSt" and "UoL inS trP"

Press SET button for 3 sec. (trA Fo menu is displayed.)

Find "SP CŪr rnt / SP UoL t" menu by scrolling UP-DOWN buttons.

Press SET button (SP CŪr Hi / SP UoL Hi menu is displayed.)

Find [(CŪr inS trP / Aut o rSt) / UoL inS trP] menu by scrolling UP-DOWN buttons.

Press SET button [(CŪr inS trP on / Aut o rSt on) / UoL inS trP off] is displayed.

Select "on" in order to activating the "instant trip function" (Aut o rSt), select "off" in order to deactivating the "instant trip function", by scrolling UP/DOWN buttons.

Press SET button, [(CŪr inS trP / Aut o rSt) / UoL inS trP] is displayed. (Selection is entered but is not activated yet. For activating the new selection, please follow the below steps).

Press ESC button one by one until "SAU E SET yES" is displayed.

Press SET button. When "SAU E SET yES" is displayed (if you press ESC button or choose "no" option instead of "yES" then new data will be cancelled and previous value will be activated).

**Programming "SP UoL t":**  
Using purposes of submenus of "SP UoL t" explained below with details.

In this menu, high set points for voltage values are programmed. Hi values for Phase-Neutral / Phase-Phase (according to Star / Delta selection) can be entered one by one.

If all the voltage values (Phase-Neutral / Phase-Phase) are under the Hi value; related relay is switched on, its LED turned on (please refer "Output") and related H LEDs are turned off.  
If all the voltage values (Phase-Neutral / Phase-Phase) are over the Hi value, H LED blinks and related output is switched off at the end of "delay on time" (Hi on dEL), its LED turned off (please refer "Output") and related H LEDs are turned on.

If all voltage (Phase-Neutral / Phase-Phase) are below the high set value (Hi) as a hysteresis voltage (UoL Hi HyS), related output is switched on at the end of the "delay off time" (Hi off dEL), its LED turned on (please refer "Output") and H LED is turned off.  
**Note:** High Voltage values are programmed for (Phase-Neutral / Phase-Phase) separately but "UoL Hi HyS" (hysteresis) and "Hi on dEL" (delay on time) and "Hi off dEL" (delay off time) values are common; these parameters have same values for Phase-Neutral / Phase-Phase.  
When Connection type (Star/Delta) is selected (refer to Connection menu), device will change the UoL Hi L-1, L-2 and L-3 values automatically according to connection.

**Example:** If the connection type is selected as Star (with neutral); UoL Hi HyS=10V UoL Hi L-1=250V, UoL Hi L-2=255V, UoL Hi L-3=260V and then this connection type is selected as Delta (without neutral), device will change the values after calculated them according to Phase-Phase values.  
**New values:**  
UoL Hi L-1 (L1-L2 Phase to phase voltage) = 433 V  
UoL Hi L-2 (L2-L3 Phase to phase voltage) = 441 V  
UoL Hi L-3 (L3-L1 Phase to phase voltage) = 450 V  
UoL Hi HyS = 10 V.  
There are 6 submenus.  
UoL Hi L-1, UoL Hi L-2, UoL Hi L-3, UoL Hi HyS, Hi on dEL, Hi off dEL.

# MULTIMETER EPM-06 / 06C / 06CS

In this menu, low set points for voltage values are programmed. Lo values for Phase-Neutral / Phase-Phase (according to Star / Delta selection) can be entered one by one.  
If all the voltage values (Phase-Neutral / Phase-Phase) are over the Lo value; related output is switched on, its LED turned on (please refer "Output") and related L LEDs are turned off.  
If any of the voltage values (Phase-Neutral / Phase-Phase) decrease the Lo value, L LED blinks and related output is switched off at the end of "delay on time" (Lo on dEL), its LED turned off (please refer "Output") and related L LED is turned on continuously. If all voltage (Phase-Neutral / Phase-Phase) values increase the low set value (Lo) as a hysteresis voltage (UoL Lo HyS), related relay is switched on at the end of the "delay off time" (Lo off dEL), its LED turned on (please refer "Output") and L LED is turned off.

**Note:** Low Voltage values are programmed for (Phase-Neutral / Phase-Phase) separately but "UoL Lo HyS" (hysteresis), "Lo on dEL" (delay on time) and "Lo off dEL" (delay off time) values are common; these parameters have same values for Phase-Neutral / Phase-Phase.  
When Connection type (Star/Delta) is selected (refer to Connection menu), device will change the UoL Lo L-1, L-2 and L-3 values automatically according to connection.  
**Example:** If the connection type is selected as Star (with neutral); UoL Lo HyS=10V  
UoL Lo L-1=180V, UoL Lo L-2=175V, UoL Lo L-3=170V and then this connection type is selected as Delta (without neutral), device will change the values after calculated them according to Phase-Phase values.  
**New values:**  
UoL Lo L-1 (L1-L2 Phase to phase voltage) = 311 V  
UoL Lo L-2 (L2-L3 Phase to phase voltage) = 303 V  
UoL Lo L-3 (L3-L1 Phase to phase voltage) = 294 V  
UoL Lo HyS = 10 V.  
There are 6 submenus.  
UoL Lo L-1, UoL Lo L-2, UoL Lo L-3, UoL Lo HyS, Lo on dEL, Lo off dEL.

High value for L1, when the Star is selected; high value for L1-L2, when the Delta selected can be defined in this menu.  
0...300 for Star connection and 0...500 for Delta connection can be defined.  
If the value is set to zero (0), the high voltage warning is disabled. Refer "SP UoL Hi" for details.  
**Note:** L2 and L3 phases can be programmed similarly.  
Low value for L1, when the Star is selected; low value for L1-L2, when the Delta selected can be defined in this menu.  
0...300 for Star connection and 0...500 for Delta connection can be defined.  
If the value is set to zero (0), the high voltage warning is disabled. Refer "SP UoL Lo" for details.  
**Note:** L2 and L3 phases can be programmed similarly.

Low value for L1, when the Star is selected; low value for L1-L2, when the Delta selected can be defined in this menu.  
0...300 for Star connection and 0...500 for Delta connection can be defined.  
If the value is set to zero (0), the high voltage warning is disabled. Refer "SP UoL Lo" for details.  
**Note:** L2 and L3 phases can be programmed similarly.

In this menu, required hysteresis voltage for high voltage warning is programmed. (same for Phase-Neutral/Phase-Phase).  
0...200V for Star connection and 0...200V for Delta connection can be defined.  
Refer "SP UoL Hi" for details.  
In this menu, required hysteresis voltage for low voltage warning is programmed. (same for Phase-Neutral/Phase-Phase).  
0...200V for Star connection and 0...200V for Delta connection can be defined.  
Refer "SP UoL Lo" for details.

**Note:** L2 and L3 phases can be programmed similarly.  
(Refer to Page-4 for SP CŪr Hi, SP CŪr Lo, SP UoL Hi Ve SP UoL Lo)

In this menu, required hysteresis voltage for high voltage warning is programmed. (same for Phase-Neutral/Phase-Phase).  
0...200V for Star connection and 0...200V for Delta connection can be defined.  
Refer "SP UoL Hi" for details.

In this menu, required hysteresis voltage for low voltage warning is programmed. (same for Phase-Neutral/Phase-Phase).  
0...200V for Star connection and 0...200V for Delta connection can be defined.  
Refer "SP UoL Lo" for details.

## Programming the "U-H HyS", "U-L HyS", "I-H HyS", "I-L HyS"

Press SET button for 3 sec. (trA Fo menu is displayed.)

Find "SP UoL t / SP CŪr rnt" menu by scrolling UP-DOWN buttons.

Press SET button (SP UoL Hi / SP CŪr Hi menu is displayed.)

Find [(SP UoL Hi / SP UoL Lo) / (SP CŪr Hi / SP CŪr Lo)] menu by scrolling UP-DOWN buttons.

Press SET button [(UoL Hi L-1 / UoL Lo L-1) / (CŪr Hi L-1 / CŪr Lo L-1) menu is displayed.]

Press SET button. Blinking the first digit of displayed value appears.

Enter the blinking digit value by scrolling UP/DOWN buttons. Switch to the other digits by using SET button, use ESC button to go to previous digit. After you entered the last digit press SET button. (UoL Hi HyS / UoL Lo HyS) / (CŪr Hi HyS / CŪr Lo HyS) is displayed. (Data is entered but is not activated yet. For activating the new data please follow the below steps).

Press ESC button one by one until "SAU E SET yES" is displayed.

Press SET button. When "SAU E SET yES" is displayed (if you press ESC button or choose "no" option instead of "yES" then new data will be cancelled and previous value will be activated).

"Delay on" time for activating the output for high voltage warning. It is common for all voltages (same for Phase-Neutral/Phase-Phase).  
The value can be programmed between 000.0 and 999.9 in terms of seconds. (Refer "SP UoL Hi" for details.)  
"Delay on" time for activating the output for low voltage warning. It is common for all voltages (same for Phase-Neutral/Phase-Phase).  
The value can be programmed between 000.0 and 999.9 in terms of seconds. (Refer "SP UoL Lo" for details.)  
"Delay off" time for activating the output for high voltage warning. It is common for all voltages (same for Phase-Neutral/Phase-Phase).  
The value can be programmed between 000.0 and 999.9 in terms of seconds. (Refer "SP UoL Hi" for details.)  
"Delay off" time for activating the output for low voltage warning. It is common for all voltages (same for Phase-Neutral/Phase-Phase).  
The value can be programmed between 000.0 and 999.9 in terms of seconds. (Refer "SP UoL Lo" for details.)

"Hi on dEL", "Hi off dEL", "Lo on dEL", "Lo off dEL" settings are explained for SP UoL t and SP CŪr rnt

Press SET button for 3 sec. (trA Fo menu is displayed.)

Find "SP UoL t / SP CŪr rnt" menu by scrolling UP-DOWN buttons.

Press SET button (SP UoL Hi / SP CŪr Hi menu is displayed.)

Find [(SP UoL Hi / SP UoL Lo) / (SP CŪr Hi / SP CŪr Lo)] menu by scrolling UP-DOWN buttons.

Press SET button [(UoL Hi L-1 / UoL Lo L-1) / (CŪr Hi L-1 / CŪr Lo L-1) menu is displayed.]

Find [(Hi on dEL / Hi off dEL / Lo on dEL / Lo off dEL) / (Hi on dEL / Hi off dEL / Lo on dEL / Lo off dEL)] menu by scrolling UP-DOWN buttons.