

User Guide



3-Phase Power and Harmonics Analyzer / Datalogger

MODEL PQ3470

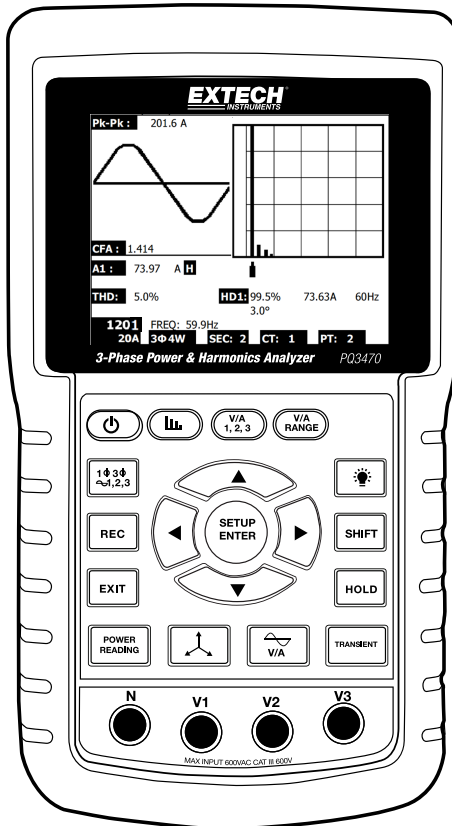

Table of Contents

1.0 INTRODUCTION	
1-1 Features	3
1-2 Safety	4
2.0 SPECIFICATIONS	
2-1 General Specifications	5
2-2 Electrical Specifications	6
3.0 METER DESCRIPTION	8
4.0 METER BASICS AND THE SETUP MODE	
4-1 Initialization Screen	10
4-2 Measurement Screen Example	10
4-3 Keypad Summary	11
4-4 Setup Mode Basics	12
4-5 Setup Mode In Detail	14
5.0 POWER MEASUREMENT PROCEDURES	
5-1 1 Φ 2W (single phase two wire) measurement	21
5-2 1 Φ 3W (single phase three wire) measurement	22
5-3 3 Φ 3W (three phase three wire) measurement	23
5-4 3 Φ 4W (three phase four wire) measurement	24
5-5 CT and PT measurement	25
5-6 Zero Adjust for Watt Hour Measurement	26
5-7 Harmonics function Measurement	26
5-8 Graphic Phasor Measurement	28
5-9 Voltage / Current Waveform	29
5-10 Transient Capture (Dips, Swells, Outage)	30
5-11 Data Logger	31
5-12 Data Hold	32
5-13 Display Backlight key	32
5-14 LOWBAT (Low Battery) screen	32
5-15 Measurement Definitions	33
5-16 Reset Button	33
6.0 MAINTENANCE	
6-1 Cleaning	34
6-2 Battery Replacement	34
7.0 SD Card	
7-1 Download Data from SD Card	35

1.0 Introduction

Congratulations on your purchase of the Model PQ3470 Power Analyzer. This instrument is fully tested and calibrated prior to delivery; proper use and care of this meter will provide years of reliable service.

1.1 Features

- Large dot-matrix, numerical, backlit LCD
- Full system analysis with up to 35 parameters:
 - Voltage (phase-to-phase) and Voltage (phase-to-ground)
 - Current (Amps) phase-to-ground
 - KW / KVA / KVAR / PF (phase)
 - KW / KVA / KVAR / PF (system)
 - KWH / KVAH / KVARH / PFH (system)
 - Phase angle
 - Harmonics
- 600.0VAC input with CAT III-600V safety rating
- Adjustable Current Transformer (CT) and Potential Transformer (PT) ratio for high power distribution systems
- Log up to 30,000 reading on removable SD memory card in Excel® format
- Wide sampling rate range (from 2 seconds up to 2 hours)
- Captured measurements imported directly into Excel™ via SD memory card
- Easy-to-use onscreen menu
- Easy-to-hold rugged over-molded housing

1.2 Safety

- CAUTION: Risk of electric shock. Do not attempt to open or disassemble the meter while taking measurements
- CAUTION: Do not attempt to measure Voltage or Current that exceeds specified limits
- Do not operate this instrument in wet or dusty environments.
- Do not operate this instrument in the presence of combustible or explosive gas
- Do not touch exposed metal parts or unused terminals.
- Consider the use of rubber gloves in operation.
- Do not operate in excess of AC 500V (Phase to Neutral), or AC 600V (Phase to Phase)
- Do not operate this instrument if it appears to be malfunctioning
- Remove the test leads from the meter before opening the battery compartment cover
- When cleaning, use only a dry cloth to wipe the meter housing. Do not use liquids of any kind to clean the meter
- Safety Symbols:

CAUTION



DOUBLE INSULATION



RISK OF ELECTRIC SHOCK



Environmental Conditions

- Installation Category III 600V
- Pollution Degree 2
- Altitude limit: 2000m
- Indoor use only
- Relative Humidity maximum: 80%

2.0 Specifications

2.1 General Specifications

Circuit	Custom single-chip microprocessor LSI circuit	
Display	LCD Size: 81.4 X 61 mm (3.2 X 2.4") Dot Matrix backlit LCD (320 X 240 pixels)	
Measurements	V (voltage phase to phase) V (voltage phase to ground) A (Current Phase to ground) KW / KVA/ KVAR / PF (Phase) KW / KVA/ KVAR / PF (System) Power factor Phase angle Frequency Harmonics	
Wire configurations	1P/2W, 1P/3W, 3P/3W, 3P/4W	
Voltage ranges	10 ACV to 600 ACV (Auto Range)	
Current ranges	Current probe input signal voltage (ACV): 200mV /300mV /500mV /1V /2V /3V Current probe input current range (ACA): 20A/200A/2000A (1200A)/30A/300A/3000A/60A/600A/6000A Note that the meter has universal probe compatibility	
Safety standard	IEC1010 CAT III 600 V	
ACV input impedance	10M ohms	
Range select	ACV	Auto Range
	ACA	Manual Range
Clamp frequency response	40 Hz to 1 KHz	
Tested clamp frequency	45 to 65 Hz	
Over-load protection	ACV	720 ACV RMS
Over-range	"OL" is displayed; ACV Data on SD card will read '9999' or '999' for over-range data	
Under-range	"UR" is displayed	
Data Hold	Freezes displayed reading	
Data Recording	SD memory card	
SD Card capacity	2G SD max. / 16G SDHC max.	
Sampling Time	Approx. 1 second	

Datalogger	Real time data logger saves data to SD memory card for download to PC (data files open directly to spreadsheet)
	Sampling rate: From 2 seconds to 7200 seconds
Data Output	Serial or USB connection (cable supplied)
Operating Temperature	0 to 50°C (32 to 122°F)
Operating Relative Humidity	80% Relative Humidity max.
Power Supply	Eight (8) 'AA' 1.5VDC batteries or AC 9V power adapter
Power Consumption	Meter: 270 mA DC; Clamp: 22 mA DC
Max. Conductor size	Clamp can accommodate up to 50 mm (2.0") diameter
Weight	Meter: 1026g (2.3 lbs.) (with batteries); Clamp: 467g (1.0lbs)
Dimensions	Meter: 225 X 125 X 64 mm (8.86 X 4.92 X 2.52")
	Optional Clamp: 210 X 64 X 33mm (8.3 X 2.5 X 1.3")
	Optional Clamp Jaw: 86 mm (3.4") Outer diameter
Accessories Included	Instruction manual Batteries SD card (2G)

2.1 Electrical Specifications (45 to 65Hz; 23±5°C)

Function	Range	Resolution	Accuracy*
AC Voltage	10.0V to 600.0V	0.1V	± (0.5% range + 3 digits)
AC Voltage (peak to peak)	28.2V to 1.697kV	0.1V to 1V	± (0.5% range + 30 digits)
AC Current (trms)	0.2A to 6000A	0.001A to 1 A	± (0.5% range + 5 digits)
AC Current (peak to peak)	2.828A to 16.97kA	0.001A to 10 A	± (0.5% range + 30 digits)
Power Factor	0.00 to 1.00	0.01	± 0.04
Φ Phase Angle	-180° to 180°	0.1°	± 1°
Frequency	45 to 65Hz	0.1Hz	0.1Hz
Power	0.0 to 3.6MW	0.001k to 0.001M	± (1% range+8 digits)
	0.0 to 3.6MVA		
	0.0 to 3.6MVAR		
Watt-Hour	0.0 to 3.6MWH	0.001k to 0.001M	± (1% range+8 digits)
	0.0 to 3.6MVAH		
	0.0 to 3.6MVARH		

*Meter accuracy only. For system accuracy add the accuracy of the clamp used.

Harmonics Magnitude (>5%, 50/60Hz)	Range	Resolution	Accuracy
ACV	1 to 20th	0.1V	± (2% + 5 digits)
	21 to 30th		± (4% + 5 digits)
	31 to 50th		Reference only
ACA	1 to 20th	0.001A to 1A	± (2% + 5 digits)*
	21 to 30th		± (4% + 5 digits)*
	31 to 50th		Reference only
Harmonics Magnitude (>5%, 50/60Hz)	Range	Resolution	Accuracy
ACV	1 to 20th	0.1%	± (2% + 10 digits)
	21 to 30th		± (4% + 20 digits)
	31 to 50th		Reference only
ACA	1 to 20th	0.1%	± (2% + 10 digits)*
	21 to 30th		± (4% + 20 digits)*
	31 to 50th		Reference only
Crest Factor (ACV or ACA)	1.000 to 9.999	0.001	± (5% + 0.3)
Total Harmonic Distortion	0 to 20%	0.1%	± (2% + 5 digits)
	20.1 to 100%		± (6% + 10 digits)
*Meter accuracy only. System accuracy includes the accuracy of the clamp used.			

PFH (Power Factor Hours): Long Term Power Factor

For three phase/four wire and three phase/three wire configurations:

$$PF\Sigma = (PF1 + PF2 + PF3) / 3$$

For single phase three wire configurations:

$$PF\Sigma = (PF1 + PF2) / 2$$

3.0 Meter Description

Meter Front, Top, and Right Side

3-1 LCD Display

3-2 Keypad (broken out below)

3-3 Measurement input terminals

3-4 SD CARD slot, RS232 jack,

AC adaptor jack, Reset button (broken out below)

3-5 Clamp Power Output jacks (broken out below)

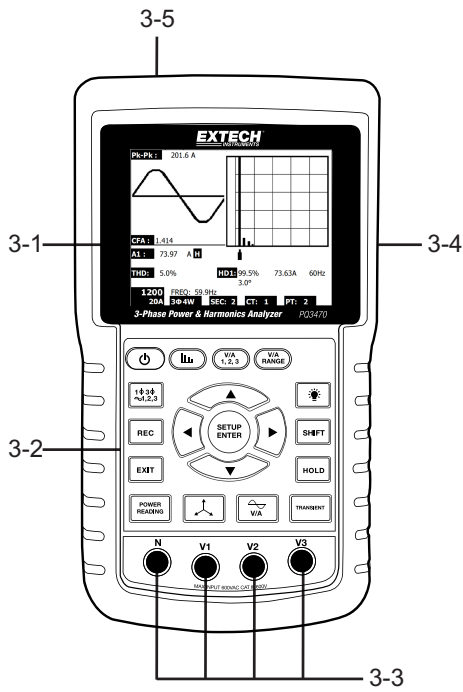

Keypad Description

- 3-6 Display Backlight ON-OFF
- 3-7 Power ON-OFF
- 3-8 Exit (programming)
- 3-9 REC datalogger memory
- 3-10 Volt/Amp range
- 3-11 Shift (programming)
- 3-12 Setup / Enter
- 3-13 HOLD (freeze display)
- 3-14 Transient display
- 3-15 V/A Waveform display
- 3-16 Phasor display
- 3-17 Power Measurement
- 3-18 ▲ up arrow navigation
- 3-19 ▼ down arrow navigation
- 3-20 ◀ left arrow navigation
- 3-21 ▶ right arrow navigation
- 3-22 Phase / Wire setup
- 3-23 Harmonics display
- 3-24 Harmonics Analysis display

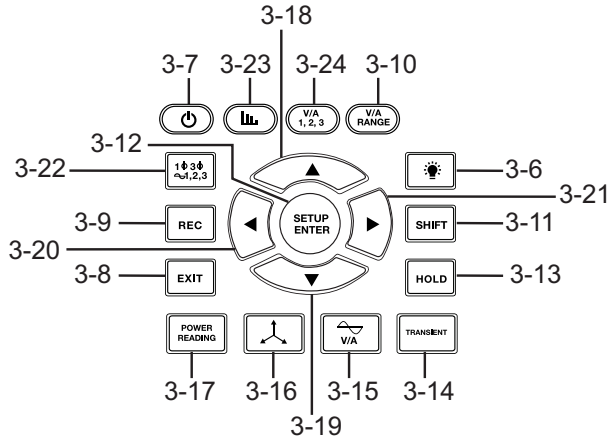

Meter Right Side

- 3-25 9V power adaptor jack
- 3-26 SD memory card socket
- 3-27 RS232 PC interface socket
- 3-28 Reset button
- 3-29 Screw fastener for protective cap

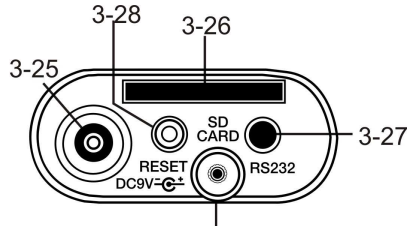

Meter Top

- 3-30 Clamp positive input jacks
- 3-31 Clamp negative input jacks
- 3-32 Clamp power lead connections

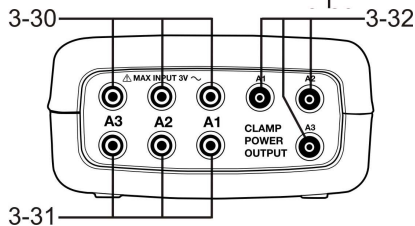

Note: The Battery compartment and Tilt Stand are located on the rear of the instrument

4.0 Meter Basics and Setup Mode

4-1 Initialization Screen

1. When the meter is switched ON the initialization screen appears (see Fig. 4-1 below).

Figure 4-1: Start-up Initialization Screen

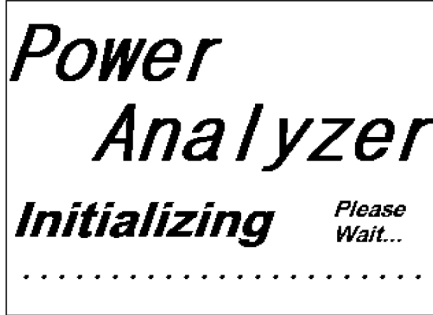

2. The meter will also check for an inserted SD memory card. 'SD check' will appear on the lower right side of the display. If an SD card is inserted, the blinking display will switch off after several seconds. When no card is inserted the display will show 'No disk'.







4-2 Measurement Screens

After the initialization screen, the meter then displays one of the measurement screen configurations. The meter reverts to the screen that was displayed at the last power down and may not be the screen shown below. Other screen configurations are shown later in this User Guide.

Measurement Screen Example

V12:	0.0 V	V1:	0.0 V	A1:	0.00 A
V23:	0.0 V	V2:	0.0 V	A2:	0.00 A
V31:	0.0 V	V3:	0.0 V	A3:	0.00 A
P1:	-0.000 KW	S1:	0.000KVA	Q1:	-0.000 KVAR
P2:	-0.000 KW	S2:	0.000KVA	Q2:	-0.000 KVAR
P3:	-0.000 KW	S3:	0.000KVA	Q3:	-0.000 KVAR
PΣ :	-0.000 KW	SΣ :	0.000KVA	QΣ :	-0.000 KVAR
PF1:	-0.00	PF 2:	-0.00	PF 3:	-0.00
PFΣ :	0.00	PF H:	0.00		
Φ1:	- 0.0°	Φ2:	- 0.0°	Φ3:	- 0.0°
WH:	0.000 KWH	SH:	0.000KVAH		
QH:	0.000 KVARH	FREQ:	0.0 Hz		
1201					SD
20A	3Φ4W	SEC: 2	CT: 1	PT: 1	Check

4.3 Keypad Summary

- **POWER** : Press and hold to power ON/OFF
- **1Φ 3Φ** (phase/wire) : Select (1P/2W, 1P/3W, 3P/3W, 3P/4W) measurement functions
- **REC** : Data record key for the SD Memory Card
- **HOLD**: Freeze the displayed reading
- **BACKLIGHT**  : Switch LCD backlight ON/OFF
- **SETUP/ENTER** : Enter the Setup mode. Also used as an Enter key to confirm entries
- **EXIT** : Exit a screen when programming
- **SHIFT**: Programming key for use in the Setup Mode
- **Up arrow** ▲ : Generally, press to move the cursor up or to change a parameter value, however use varies with each particular function
- **Down arrow** ▼ : Generally, press to move the cursor down or to change a parameter value, however use varies with each particular function
- **Left arrow** ◀: Use varies according to a particular function
- **Right arrow** ▶: Use varies according to a particular function
- **Volt/Amp Range**: Select a range for voltage or current harmonic measurements
- **Transient display** : Capture transient measurements
- **V/A Waveform display**  : View waveform representations of voltage and current
- **Phase diagram**  : View measurements in vector display format
- **Power Reading** : Display power measurements
- **Harmonics display**  : Display Harmonics
- **Harmonics Analysis**  : View the Harmonics analysis

4.4 Setup Mode

4.4.1 Setup Mode Basics

1. Press the SETUP button to access the Setup Mode. The screen shown below will appear on the meter's LCD.
2. Use the up and down arrow keys to scroll through the parameters.
3. Press the SHIFT key to open a particular parameter for editing (the 'SHIFT 1' display icon will be visible on the upper right hand corner of the LCD).
4. Once a parameter is opened for editing (parameter variable highlighted), use the up and down arrow keys to change the variable.
5. When the SHIFT key is pressed on the FILE NAME parameter, the user can select the first half of the file name which is the configuration (3P4, for example). When the SHIFT keys is pressed again, the SHIFT 2 icon appears on the display and the user can select the second half of the file name (10001.XLS, for example). See Figure 4-4b for an example of the SHIFT 2 screen. This applies only to the FILENAME parameter.
6. Press the SHIFT key to continue scrolling through the other parameters using the up and down arrow keys.
7. Note that to enter the RS-232 parameter, scroll to the RS-232 OUT SEL parameter and press the SETUP key to open the multi-page RS-232 output selection. Refer to the RS-232 section of this guide for more detailed information.
8. To exit the Setup Mode press the EXIT key.
9. Detailed instructions for each parameter are provided in the next section.

Setup Mode Screen with SHIFT 1 icon

Folder Name:	WTA01					SETUP
File Name:	3P401001.XLS					SHIFT 1 ←
REC Date:	2008-11-28 00:03:17					
Sampling Time:	2	Trans Ref :	220.0 V			
Delet File:	0 %	SDVP :	10%			
SD Format:	0 %	Decimal:	USA (.)			
Use Size:	388 KB	Clamp Type:	OTHER			
Free Size:	1946 MB	A Range:	200A			
Total Size:	1946 MB	V Range:	200mV			
		RS232 Out Sel:				
PT:	1 : 1	V1	I1	P1		
CT:	1 : 1	S1	Q1	PF1		
Beep:	ON	Φ1	FREQ			
Year	Month	Date	Hour	Minute	Second	
2010	11	13	14	37	25	

Setup Mode Screen with SHIFT 2 icon

Folder Name:	WTA01					SETUP
File Name:	3P401001.XLS					SHIFT 2 ←
REC Date:	2008-11-28 00:03:17					
Sampling Time:	2	Trans Ref :	220.0 V			
Delet File:	0 %	SDVP :	10%			
SD Format:	0 %	Decimal:	USA (.)			
Use Size:	388 KB	Clamp Type:	OTHER			
Free Size:	1946 MB	A Range:	200A			
Total Size:	1946 MB	V Range:	200mV			
		RS232 Out Sel:				
PT:	1 : 1	V1 I1:	P1			
CT:	1 : 1	S1 Q1:	PF1			
Beep:	ON	Φ1 FREQ:				
Year	Month	Date	Hour	Minute	Second	
2010	11	13	14	37	25	

4.4.2 The Setup Mode Parameter Menu

- **Folder Name:** Select a file name on the SD CARD; the range is WTA01 to WTA10
- **File Name:** Set a file name on the SD CARD (50 filenames are permitted)
- **REC Date:** Show a file's date-time stamp (Year / Month / Date / Hour / Min / Sec)
- **Sampling Time:** Set the datalogger sampling rate from 2 to 7200 seconds
- **Delete File:** Delete an existing data file from the SD CARD
- **SD Format:** Format the SD CARD
- **PT:** Set the Potential Transformer ratio from 1 to 1000
- **CT:** Set the Current Transformer ratio from 1 to 600
- **Audible Tone:** Set the keypad beeper ON or OFF
- **Trans. Ref.:** Set the Transient voltage reference
- **SDVP:** Set the threshold for the Swells/Dips transient Voltage Potential in percent (0-100%)
- **Clamp Type:** Select from the clamp type menu
- **A (Amps):** Set the Current range
- **V (Volts):** Set the Voltage range
- **RS232 Out Select:** RS232 output function (up to nine items can be output); refer to the RS232 section of the user guide for detailed information
- **Year:** Set the current year
- **Month:** Set the current month
- **Date:** Set the current date
- **Hour:** Set the current hour
- **Minute:** Set the current minute
- **Second:** Set the current second

4.5 Setup Mode in Detail

Press SETUP to enter the Setup Mode, selected items will appear highlighted (reverse video). As described in the Setup Mode Basics section above, use the up and down arrow keys to move through the available parameters and use the Shift key to open a parameter for editing. Once a parameter is opened for editing, the up and down arrow keys are used again to change a parameter's setting. The SHIFT key is then used to return to Setup Mode editing where the arrow keys are used again for scrolling. Use the EXIT key to leave the Setup Mode.

4.5.1 Folder name: Set a Folder Name on the SD Memory Card

1. Scroll to the FOLDER NAME field using the up and down arrow keys if necessary
2. The Folder Name range is "WTA01" to "WTA10" (refer to Figure 4-5-1a below)
3. Press Shift to open the Folder Name parameter for editing
4. Use the arrow keys ▲ ▼ to select a folder number; the available numbers are "01 to 10" (Note: Press and hold ▲ or ▼ continuously for at least two seconds to scroll quickly).
5. Press SHIFT when done

Folder Name (Screen 1)

Folder Name:	WTA01					SETUP
File Name:	3P401001.XLS					
REC Date:	2008-11-28 00:03:17					
Sampling Time:	2	Trans Ref:	220.0V			
Delete File:	0 %	sdvp:	10%			
SD Format:	0 %	Decimal:	USA (.)			
Use Size:	388 KB	Clamp Type:	200A			
Free Size:	1946 MB	A Range:	20A			
Total Size:	1946 MB	V Range:	200mV			
		RS232 Out Sel:				
PT:	1 : 1	V1	I1	P1		
CT:	1 : 1	S1	Q1	PF1		
Beep:	ON	Φ1	FREQ			
Year	Month	Date	Hour	Minute	Second	
2010	'11	'13	'14	'37	'25	

Folder Name (Screen 2)

Folder Name:	WTA01					SETUP
File Name:	3P401001.XLS					SHIFT1
REC Date:	2008-11-28 00:03:17					
Sampling Time:	2	Trans Ref:	220.0V			
Delete File:	0 %	sdvp:	10%			
SD Format:	0 %	Decimal:	USA (.)			
Use Size:	388 KB	Clamp Type:	200A			
Free Size:	1946 MB	A Range:	20A			
Total Size:	1946 MB	V Range:	200mV			
		RS232 Out Sel:				
PT:	1 : 1	V1	I1	P1		
CT:	1 : 1	S1	Q1	PF1		
Beep:	ON	Φ1	FREQ			
Year	Month	Date	Hour	Minute	Second	
2010	'11	'13	'14	'37	'25	

4.5.2 File name: Set a file name in the SD Memory Card

1. In the Setup Mode, scroll down to the FILE NAME parameter using the up and down arrow keys
2. The screen will show the "NO FILE" indicator in the REC Date option area when the selected file is new.
3. The screen will show the recording date and time in the REC Date option area for existing data files.

File Name (Screen 1)

Folder Name:	WTA01					SETUP
File Name:	3P401001.XLS					
REC Date:	NO File					
Sampling Time:	2	Trans Ref:	220.0V			
Delete File:	0 %	sdvp:	10%			
SD Format:	0 %	Decimal:	USA (.)			
Use Size:	388 KB	Clamp Type:	200A			
Free Size:	1946 MB	A Range:	20A			
Total Size:	1946 MB	V Range:	200mV			
		RS232 Out Sel:				
PT:	1 : 1	V1	I1	P1		
CT:	1 : 1	S1	Q1	PF1		
Beep:	ON	Φ1	FREQ			
Year	Month	Date	Hour	Minute	Second	
2010	'11	'13	'14	'37	'25	

File Name (Screen 2)

Folder Name:	WTA01					SETUP
File Name:	3P401001.XLS					
REC Date:	2008-11-28 00:03:17					
Sampling Time:	2	Trans Ref:	220.0V			
Delete File:	0 %	sdvp:	10%			
SD Format:	0 %	Decimal:	USA (.)			
Use Size:	388 KB	Clamp Type:	200A			
Free Size:	1946 MB	A Range:	20A			
Total Size:	1946 MB	V Range:	200mV			
		RS232 Out Sel:				
PT:	1 : 1	V1	I1	P1		
CT:	1 : 1	S1	Q1	PF1		
Beep:	ON	Φ1	FREQ			
Year	Month	Date	Hour	Minute	Second	
2010	'11	'13	'14	'37	'25	

4. Press the SHIFT button. The "SHIFT 1" icon will appear on the upper right side of the screen and the first half of the File Name which represents the number of wires and phases (3P4, for example) will be highlighted and ready for editing. Use the arrow keys to select the desired configuration. Select 1P/2W (1P2), 1P/3W (1P3), 3P/3W (3P3), or 3P/4W (3P4). See Figure 4-5-2c below.
5. Press SHIFT again and the "SHIFT 2" icon will appear on the upper right side of the screen and the second half of the File Name, which the user can customize as needed, will be highlighted. Use the arrow keys to select a number between 001 and 0050 inclusive. See Figure 4-5-2d below.
6. File Name Examples:
 - a. **1P201001:** 1P2 is one phase by two wires, 01 is the folder number, and 001 is the file number
 - b. **1P301001:** 1P3 is one phase by three wires, 01 the folder number, and 001 the file number
 - c. **3P301001:** 3P3 is three phases by three wires, 01 the folder number, and 001 the file number.
 - d. **3P401001:** 3P4 is three phases by four wires, 01 the folder number, and 001 the file number.

- Press the SHIFT key again to continue with the Setup Mode editing.

File Name (Screen 3)

Folder Name:	WTA01					SETUP
File Name:	3P4	01001.XLS				SHIFT1
REC Date:	2008-11-28 00:03:17					
Sampling Time:	2	Trans Ref:	220.0V			
Delete File:	0 %	sdvp:	10%			
SD Format:	0 %	Decimal:	USA (.)			
Use Size:	388 KB	Clamp Type:	200A			
Free Size:	1946 MB	A Range:	20A			
Total Size:	1946 MB	V Range:	200mV			
	RS232 Out Sel:					
PT:	1 : 1	V1	I1	P1		
CT:	1 : 1	S1	Q1	PF1		
Beep:	ON	Φ1	FREQ			
Year	Month	Date	Hour	Minute	Second	
2010	'11	'13	'14	'37	'25	

File Name (Screen 4)

Folder Name:	WTA01					SETUP
File Name:	3P4	01001.XLS				SHIFT2
REC Date:	2008-11-28 00:03:17					
Sampling Time:	2	Trans Ref:	220.0V			
Delete File:	0 %	sdvp:	10%			
SD Format:	0 %	Decimal:	USA (.)			
Use Size:	388 KB	Clamp Type:	200A			
Free Size:	1946 MB	A Range:	20A			
Total Size:	1946 MB	V Range:	200mV			
	RS232 Out Sel:					
PT:	1 : 1	V1	I1	P1		
CT:	1 : 1	S1	Q1	PF1		
Beep:	ON	Φ1	FREQ			
Year	Month	Date	Hour	Minute	Second	
2010	'11	'13	'14	'37	'25	

4.5.3 Set the Sampling Time (datalogging rate) for recording onto the SD Memory Card

- In the Setup Mode, use the up and down arrow keys to scroll to the SAMPLING TIME field.
- Press the SHIFT key and the symbol "SHIFT1" will switch ON.
- Use the arrow keys to adjust the sampling time; the range is 2 to 7200 seconds.
- Press the SHIFT key again to return to Setup Mode editing.

4.5.4 Delete a file on the SD Memory Card

1. In the Setup Mode, scroll to the DELETE FILE field using the up and down arrow keys.
2. Press and hold the SETUP/ENTER key for at least 2 seconds and the indicators "Y" and "N" will appear next to the DELETE FILE field. Use the right and left arrow keys to highlight "Y" for YES or "N" for NO and then momentarily press the SETUP/ENTER key.
3. If "Y" is selected, the current file will be erased. If "N" is selected, the delete process will be aborted. When a file is deleted the field next to DELETE FILE will show 100%. When a delete is aborted, the field shows 0%.

4.5.5 Formatting an SD Memory Card

1. In the Setup Mode, use the arrow keys to scroll to the SD FORMAT field
2. Press and hold the SETUP/ENTER button for at least 2 seconds and the "Y" and "N" indicators will appear next to the SD FORMAT field
3. Use the right and left arrow buttons to highlight the desired letter: "Y" to confirm formatting or "N" to abort the formatting.
4. While formatting, the field next to the SD FORMAT field will show the formatting progress 0 to 100%.
5. Note that the display screen shows USE SIZE (amount of memory currently used on the SD card), FREE SIZE (amount of memory available), and TOTAL SIZE (total size of the SD card memory) below the SD FORMAT field.

4.5.6 Potential Transformer (PT) Setup

1. In the Setup Mode, use the up and down arrow keys to scroll to the PT field.
2. Press SHIFT, the display "SHIFT1" will switch ON
3. Use the ▲ or ▼ keys to adjust the PT value (the range is 1 to 1000)
4. Press SHIFT again to return to Setup Mode editing or press EXIT to leave the Setup mode.

4.5.7 Current Transformer (CT) Setup

1. In the Setup Mode, use the up and down arrow keys to scroll to the CT field.
2. Press SHIFT, the display "SHIFT1" will switch ON
3. Use the ▲ or ▼ keys to adjust the CT value (the range is 1 to 600)
4. Press SHIFT again to return to Setup Mode editing or press EXIT to leave the Setup mode.

4.5.8 Audible Beeper ON/OFF

1. In the Setup Mode, use the up and down arrow keys to scroll to the BEEP field.
2. Press SHIFT, the display "SHIFT1" will switch ON
3. Use the ▲ or ▼ keys to select ON or OFF
4. Press SHIFT again to return to Setup Mode editing or press EXIT to leave the Setup mode.

4.5.9 Transient Reference (Trans. Ref.)

The Transient Reference parameter sets the nominal voltage used for a transient detect reference.

1. In the Setup Mode, use the up and down arrow keys to scroll to the TRANS REF field.
2. Press SHIFT, the display "SHIFT1" will switch ON
3. Use the ▲ or ▼ keys to select the desired voltage reference (from 50.0V to 850.0V)
4. Press SHIFT again to return to Setup Mode editing or press EXIT to leave the Setup mode.

4.5.10 SDVP (Swells/Dips Voltage)

The SDVP parameter sets the upper and lower limit range (in %) for the transient voltage detection. For example, if the Transient Reference is set to 200V and the SDVP is set to 10%, the SDVP range will be 180V to 220V.

1. In the Setup Mode, use the up and down arrow keys to scroll to the SDVP field.
2. Press SHIFT, the display "SHIFT1" will switch ON
3. Use the ▲ or ▼ keys to select the desired voltage threshold (1% to 100%)
4. Press SHIFT again to return to Setup Mode editing or press EXIT to leave the Setup mode.

4.5.11 SD Card Numerical Format (USA or European)

Note: SD Memory Cards default to the basic numerical format (USA) whereby a period is used to separate units from tenths, for example: 20.00. European formatting uses a comma, for example: 20,00.

1. In the Setup Mode, use the up and down arrow keys to scroll to the DECIMAL field.
2. Press SHIFT, the display "SHIFT1" will switch ON
3. Use the ▲ or ▼ keys to select the desired format (USA or EURO)
4. Press SHIFT again to return to Setup Mode editing or press EXIT to leave the Setup mode.

4.5.12 Set Clamp type

1. In the Setup Mode, use the up and down arrow keys to scroll to the CLAMP TYPE field.
2. Press SHIFT, the display "SHIFT1" will switch ON
3. Use the ▲ or ▼ keys to select the appropriate clamp type.
4. Press SHIFT again to return to Setup Mode editing or press EXIT to leave the Setup mode.

4.5.13 Set Current Range

ATTENTION: Ensure that the 'A' range setting matches the attached clamp's rating

1. In the Setup Mode, use the up and down arrow keys to scroll to the "A RANGE" field.
2. Press SHIFT, the display "SHIFT1" will switch ON.
3. Use the ▲ or ▼ keys to select the current range.
4. Press SHIFT again to return to Setup Mode editing or press EXIT to leave the Setup mode.

4.5.14 Set Voltage Range

1. In the Setup Mode, use the up and down arrow keys to scroll to the "V RANGE" field.
2. Press SHIFT, the display "SHIFT1" will switch ON
3. Use the ▲ or ▼ keys to select the voltage (**Note** that unless the CLAMP TYPE is set to OTHER, this value is fixed)
4. Press SHIFT again to return to Setup Mode editing or press EXIT to leave the Setup mode.

4.5.15 Set RS-232 Output Parameters

1. In the Setup Mode, use the up/down arrow keys to scroll to the "RS232 OUT SEL" field.
2. Press the SETUP/ENTER key to access the RS232 Output selection mode. There are four (4) pages of output selections, nine of which can be selected at any one time.
3. Use all of the four arrow buttons to navigate the output choices.
4. To select an output type, press the SETUP key (the selection will highlight).
5. To de-select a selected output type, press the SETUP key (the highlight will switch off).
6. Press and hold the SHIFT key for > 2 seconds to clear all RS-232 output selections.
7. To scroll from page to page, press the SHIFT button momentarily (there are four pages).
8. Press the EXIT button to exit the RS232 output mode.
9. If more than nine items are selected the display will show the indicator "full".

RS232 – Output Selection Pages

RS232 OUTPUT SELECT		
1. V12	12. P3	23. PF2
2. V23	13. P5	24. PF3
3. V31	14. S1	25. PFZ
4. V1	15. S2	26. PFH
5. V2	16. S3	27. Q1
6. V3	17. SE	28. Q 2
7. I1	18. Q1	29. Q 3
8. I2	19. Q2	30. WHI
9. I3	20. Q3	31. SH
10. P1	21. Q5	32. OH
11. P2	22. PF1	33. FREQ

RS232 OUTPUT SELECT		
34. H01	45. H12	56. H23
35. H02	46. H13	57. H24
36. H03	47. H14	58. H25
37. H04	48. H15	59. H26
38. H05	49. H16	60. H27
39. H06	50. H17	61. H28
40. H07	51. H18	62. H29
41. H08	52. H19	63. H30
42. H09	53. H20	64. H31
43. H11	54. H21	65. H32
44. H01	55. H22	66. H33

RS232 OUTPUT SELECT		
67. H34	78. H45	89. Q V12
68. H35	79. H46	90. Q V23
69. H36	80. H47	91. Q V31
70. H37	81. H48	92. Q V1
71. H38	82. H49	93. Q V2
72. H39	83. H50	94. Q V3
73. H40	84. THD	95. Q A1
74. H41	85. Vpp	96. Q A2
75. H42	86. CFV	97. Q A3
76. H43	87. App	98. AveV
77. H44	88. CFA	99. AveA

RS232 OUTPUT SELECT	
100. Vn	
101. An	
102. dv	
103. VdR	
104. Vd0	
105. Vd2	
106. dA	
107. AJR	
108. Ad0	
109. Ad2	

4.5.16 Set Time and Date

1. In the Setup Mode, use the up and down arrow keys to scroll to the YEAR, MONTH, DATE, HOUR, MINUTE, and SECOND fields.
2. Press SHIFT key when the desired field is selected, the display "SHIFT1" will switch ON
3. Use the ▲ or ▼ keys to change the date or time value
4. Press SHIFT again to return to Setup Mode editing or press EXIT to leave the Setup mode.

4.5.17 Exit the Setup Mode

When all of the programming has been completed, press the EXIT key to return to the measurement mode of operation.

5.0 Power Measurement Procedures

5.1 1 Φ 2W (Single Phase - Two Wire) Measurement

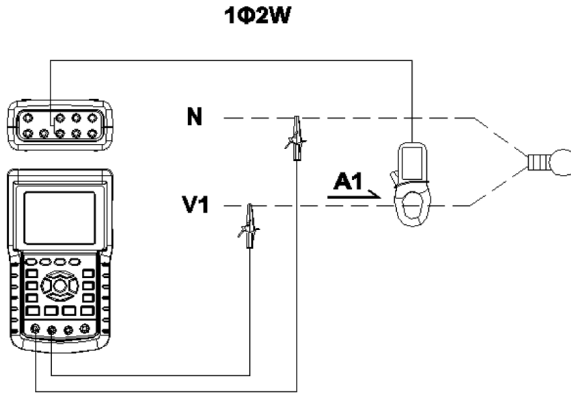

1. Power the instrument ON by pressing the 'Power' key (item 3-7; Section 3 diagrams), and then use the '1 Φ 3 Φ ' key (item 3-22) to select the 1 Φ 2W system, the selected name of the system will be shown on the bottom left side of the display (refer to Figure 5-1 below)
2. Connect the line voltage L1, Vn (Neutral) to V1 and N terminals of the instrument.
3. Connect the Clamp (A1) to the conductor (A1)
4. Connect Clamp 1 (A1) to the A1 terminal of the instrument
5. The related measurement factors will appear on the display
6. Measurement definitions can be found in Section 5-15

Figure 5-1

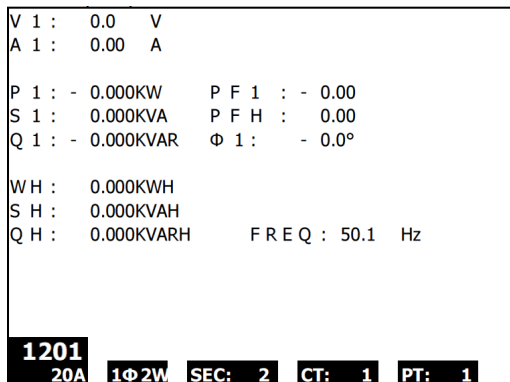

5.2 1Φ3W (single phase - three wire) Measurement

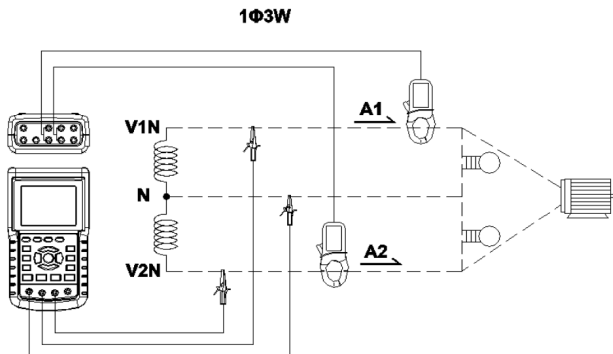

1. Power the instrument ON by pressing 'Power' key (item 3-7; Section 3 diagrams), and then press the '1Φ 3Φ' key (item 3-22) to select 1Φ 3W, the selected name of the configuration will appear on bottom left hand side of the display.
2. Connect the line voltage L1, L2 and Vn (Neutral) to V1, V2 and N terminals of the instrument
3. Connect the two (2) clamps (A1 and A2) to the conductors (A1) and (A2)
4. Connect Clamp 1 and Clamp 2 (A1 and A2) to the A1 and A2 terminals of the instrument
5. The related measurement factors will appear on the display
6. Measurement definitions can be found in Section 5-15

Figure 5-2

V 1 :	0.0	V	P 1 :	-	0.000KW
V 2 :	0.0	V	P 2 :	-	0.000KW
A 1 :	0.00	A	S 1 :	0.000KVA	
A 2 :	0.00	A	S 2 :	0.000KVA	
Q 1 :	-	0.000KVAR			
Q 2 :	-	0.000KVAR			
PS :	0.000	KW	SΣ :	0.000	KVA
PF1:	-	0.00	PF2:	-	0.00
PFH:	0.00		Φ1:	-	0.0°
WH:	0.000	KWH	SH:	0.000	KVAH
QH:	0.000	KVARH	FREQ:	50.0	Hz
1201					
20A	1Φ3W	SEC: 2	CT: 1	PT: 1	

5.3 3Φ 3W (three phase - three wire) Measurement

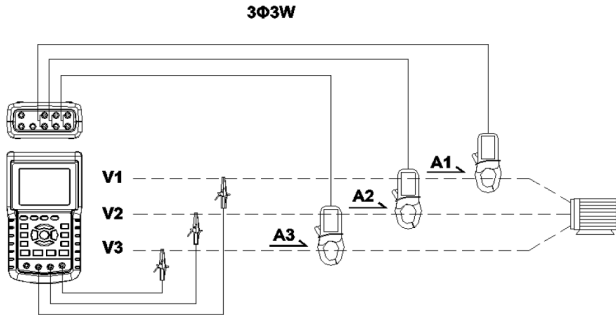

1. Power the instrument ON by pressing the 'Power' key (item 3-7; Section 3 diagrams), and then press '1Φ 3Φ' (item 3-22) to select 3Φ 3W, the selected configuration name will appear on bottom left hand side of the display.
2. Connect the line voltage L1, L2 and L3 to V1, V2 and V3 terminals of the instrument.
3. Connect the three (3) clamps (A1, A2, A3) to conductors A1, A2 , A3
4. Connect the three (3) Clamps to the meter using the A1, A2, and A3 terminals
5. The related measurement factors will appear on the display
6. Measurement definitions can be found in Section 5-15

Figure 5-3

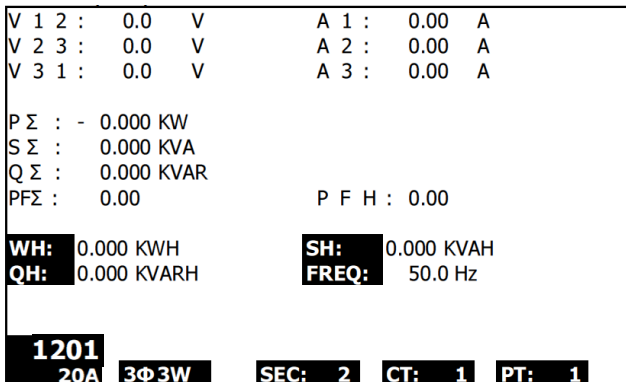

5.4 3Φ 4W (three phase - four wire) Measurement

3Φ4W

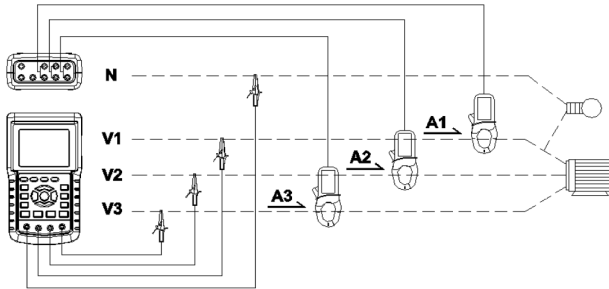

1. Power the instrument ON by pressing the 'Power' key (item 3-7; Section 3 diagrams), and then press '1Φ 3Φ' (item 3-22) to select the 3Φ 4W system, the selected name of the system will appear on the bottom left hand side of the display.
2. Connect the line voltage L1, L2, L3 and Vn to V1, V2, V3 and N terminals of the instrument.
3. Connect the three (3) Clamps (A1, A2, and A3) to the conductors A1, A2, and A3.
4. Connect the Clamps (A1, A2, and A3) to the meter's A1, A2, and A3 terminals.
5. The related measurement factors will appear on the display.
6. Measurement definitions can be found in Section 5-15.

Figure 5-4

V12: 0.0 V	V1: 0.0 V	A1: 0.00 A
V23: 0.0 V	V2: 0.0 V	A2: 0.00 A
V31: 0.0 V	V3: 0.0 V	A3: 0.00 A
P1: - 0.000 KW	S1: 0.000 KVA	Q1: - 0.000 KVAR
P2: - 0.000 KW	S2: 0.000 KVA	Q2: - 0.000 KVAR
P3: - 0.000 KW	S3: 0.000 KVA	Q3: - 0.000 KVAR
PΣ: - 0.000 KW	SΣ: 0.000 KVA	QΣ: - 0.000 KVAR
PF1: - 0.00	PF2: - 0.00	PF3: - 0.00
PFΣ: 0.00	PFH: 0.00	Φ3: - 0.0°
Φ1: - 0.0°	Φ2: - 0.0°	
WH: 0.000 KWH	SH: 0.000 KVAH	
QH: 0.000 KVARH	FREQ: 0.0 Hz	
1201		
20A	3Φ4W	SEC: 2 CT: 1 PT: 1

5.5 Current (CT) / Potential (PT) Transformer Measurement

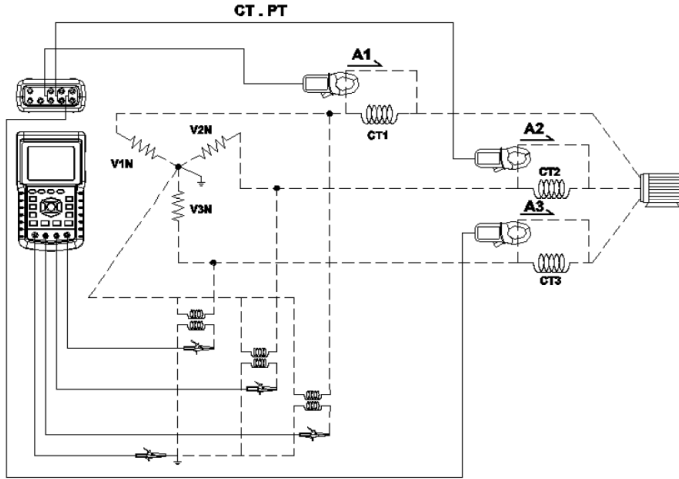

1. Power the instrument ON by pressing the 'Power' key (item 3-7; Section 3 diagrams), and then press the '1 Φ 3 Φ ' key (item 3-22) to select the 3 Φ 4W system, the selected name of the system will appear on the bottom left hand side of the display.
2. Connect the line voltage L1, L2, L3 and Vn to the V1, V2, V3 and N terminals of the instrument
3. Connect the three (3) Clamps (A1, A2, A3) to the conductors A1, A2, A3
4. Connect the Clamps (A1, A2, A3) to the meter's A1, A2, A3 terminals
5. The related measurement factors will appear on the display
6. Measurement definitions can be found in Section 5-15

Figure 5-5

V12:	0.0 V	V1:	0.0 V	A1:	0.00 A
V23:	0.0 V	V2:	0.0 V	A2:	0.00 A
V31:	0.0 V	V3:	0.0 V	A3:	0.00 A
P1:	- 0.000 KW	S1:	0.000 KVA	Q1:	- 0.000 KVAR
P2:	- 0.000 KW	S2:	0.000 KVA	Q2:	- 0.000 KVAR
P3:	- 0.000 KW	S3:	0.000 KVA	Q3:	- 0.000 KVAR
PΣ	- 0.000 KW	SΣ	0.000 KVA	QΣ	- 0.000 KVAR
PF1:	- 0.00	PF2:	- 0.00	PF3:	- 0.00
PFΣ	0.00	PFH:	0.00		
Φ1:	- 0.0°	Φ2:	0.0°	Φ3:	0.0°
WH:	0.000 KWH	SH:	0.000 KVAH		
QH:	0.000 KVARH	FREQ:	0.0 Hz		
1201					
20A	3Φ4W	SEC: 2	CT: 1	PT: 1	

5.6 – Zero Adjustment for the ‘Watt Hour’ Function

Press and hold the "Exit" key for at least 6 seconds, the measurement values for "WH", "SH", "QH" will reset to a Zero value.

5.7 – Harmonic Function Measurements

1. Press the 'Harmonic' key  to enter Screen 1.
2. Press the 'V/A 1. 2. 3' key to enter Screen 2.
3. If the waveform is distorted, press the "V/A range Key" to switch to VH or AH to remove distortion from the waveform (as shown in Screen 3 and Screen 4)
4. Press the 'Left' key or the "Right Key" to show the n th harmonic value of the current or the voltage.

Harmonics - Screen 1

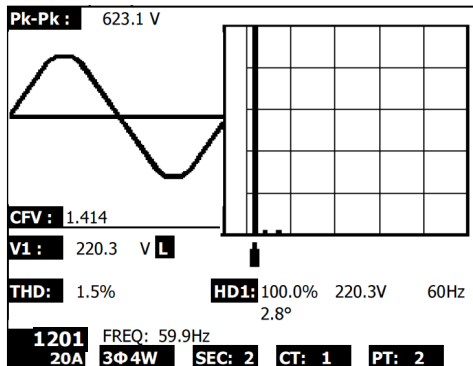

Harmonics - Screen 2

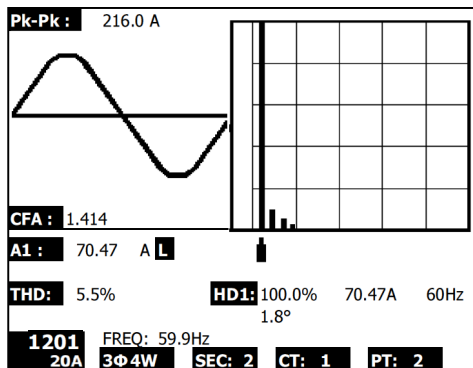

Harmonics - Screen 3

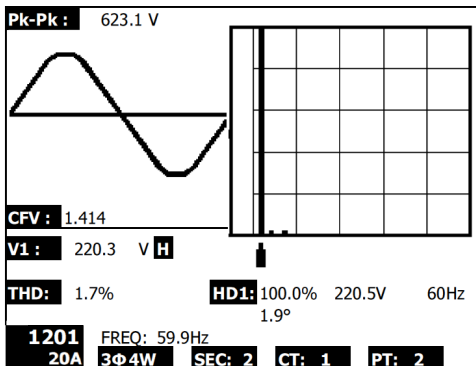

Harmonics - Screen 4

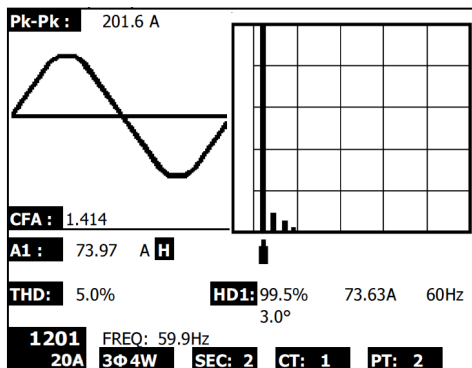

5.8 – Graphic Phasor Diagram

1. Press the Phasor key  to display the Phasor as shown in Screen 1 for Figure 5-8a below.

2. Description of Phasor diagram:

- V1, V2, V3: Phase voltages in phasor format with respect to V1
- A1, A2, A3: Line currents in phasor format with respect to A1.
- AVE: Average of the line voltages V12, V23, V31 and the line current A1, A2, and A3
- AVn: Calculated voltage and current of the neutral with respect to ground.
- dV%: Historical maximum % for $\text{MAX}(V123) - \text{MIN}(V123) / \text{MIN}(V123) * 100\%$
- VUR: Voltage ratio (unbalanced)
- D02 (d0,d2): d0=The first number in the zero sequence unbalanced ratio in % (d0) of voltage or current. d2=The second number in the negative sequence unbalanced ratio in % (d2) of voltage or current.
- dA%: Historical maximum % for $\text{MAX}(A123) - \text{MIN}(A123) / \text{MIN}(A123) * 100\%$
- AUR: Current ratio (unbalanced)

Figure 5-8a: Phasor - Screen 1

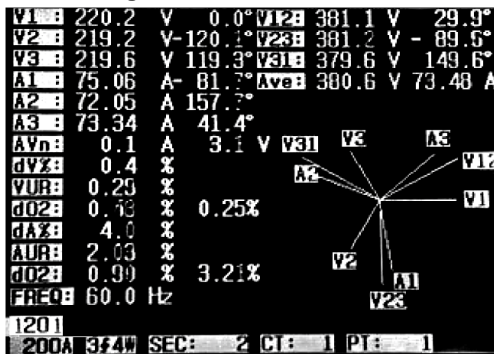

Figure 5-8b: Phasor - Screen 2



5.9 – Voltage Current Waveform

1. Press Waveform  to enter the Voltage Waveform screen as shown in Screen 1 below, and then Press the "1 Φ /3 Φ " key to switch the Voltage waveform from V1 to V2 to V3, etc.
2. Press the Waveform key again to enter the Current Waveform screen as shown in Screen 2 below, and then press the "1 Φ /3 Φ " key to switch the Current waveform from A1 to A2 to A3, etc.
3. Press the Waveform key again to enter the Voltage/Current Waveform screen as shown in Screen 3 below, and then press the "1 Φ /3 Φ " key to switch the Voltage/Current waveform from V1/A1 to V2/A2 to V3/A3, etc.

Figure 5-9c: Waveforms - Screen 1

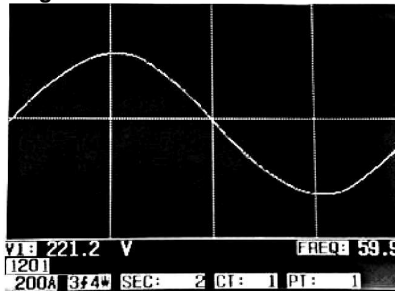

Figure 5-9b: Waveforms - Screen 2

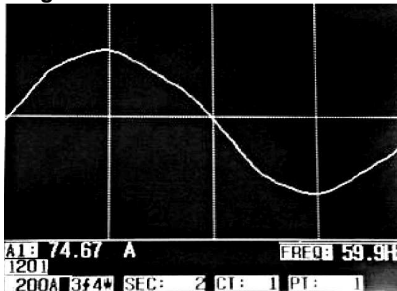
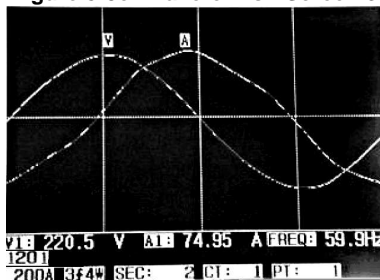

Figure 5-9c: Waveforms - Screen 3



5.10 – Transient Capture (Dips, Swells, and Outages)

- To use the Transient Capture function, first set the Transient Reference Voltage level and the SDVP (Swell/Dip voltage percentage) value per sections 4-5-9 and 4-5-10 respectively.
- Press the TRANSIENT key to enter the Transient Capture screen.
- Insert the SD memory card to the slot at the right side of the meter and then press the REC button to begin datalogging, refer to Screen 1 below.
- Definitions:
 - SWELL: $V_{rms} > (V_{ref} + [V_{ref} * SDVP\%])$
 - DIP: $V_{rms} < (V_{ref} - [V_{ref} * SDVP\%])$
 - OUTAGE: $< 30V$ to $40V$
- Note that 'V' will appear in the LINE column if all phases experience a transient. V1, V2, or V3 will appear in the LINE column if a specific phase experiences a transient; Refer to Screen 2 below.
- Press the POWER READING button to exit the Transient Capture mode and return to the normal operating mode.
- One screen can display up to 13 transient events. One file can record 99 transient events. When dealing with more than 13 transient events use the up and down arrow keys to view the additional data. When fewer than 13 transient events are listed, the arrow buttons are disabled.

Figure 5-10a: Transient Capture - Screen 1

NO	DATE	TIME	LINE	STATUS
1201	REF: 220.0 V			REC
200A	3#4W	SEC: 2	CT: 1	PT: 1

NOTE: Each time the 1Φ 3Φ button is pressed, the meter steps through the transient mode wire configuration list (1P2W, 1P3W, 3P3W, and 3P4W)

Figure 5-10b: Transient Capture - Screen 2

NO	DATE	TIME	LINE	STATUS
1	2011-03-01	10:12:09	V3	DIP-OUTAGE
2	2011-03-01	10:12:10	V3	DIP-OUTAGE
3	2011-03-01	10:13:21	V1	SWELL
4	2011-03-01	10:13:21	V	DIP
5	2011-03-01	10:13:22	V	DIP-OUTAGE
6	2011-03-01	10:13:30	V	DIP-OUTAGE
7	2011-03-01	10:13:41	V2	DIP
8	2011-03-01	10:13:41	V2	DIP-OUTAGE
9	2011-03-01	10:13:43	V2	SWELL

1201	REF: 220.0 V			REC
200A	3#4W	SEC: 2	CT: 1	PT: 1

5.11 – Datalogger Function

1. Press the REC key once to begin.
2. If the meter displays the "Change Card" message at the bottom right, the SD CARD memory is either full or it is damaged.
3. If the meter displays "NO DISK" an SD card must be inserted before datalogging can begin.
4. If 'Check SD' appears, wait a few seconds as the meter is reading the SD card.
5. If the SD CARD is functional and it has available space datalogging will begin.

V12: 0.0 V	V1: 0.0 V	A1: 0.00 A
V23: 0.0 V	V2: 0.0 V	A2: 0.00 A
V31: 0.0 V	V3: 0.0 V	A3: 0.00 A
P1: - 0.000 KW	S1: 0.000 KVA	Q1: - 0.000 KVAR
P2: - 0.000 KW	S2: 0.000 KVA	Q2: - 0.000 KVAR
P3: - 0.000 KW	S3: 0.000 KVA	Q3: - 0.000 KVAR
PΣ - 0.000 KW	SΣ : 0.000 KVA	QΣ : - 0.000 KVAR
PF1: - 0.00	PF2: - 0.00	PF3: - 0.00
PFΣ : 0.00	PFH: 0.00	
Φ 1: - 0.0°	Φ 2: - 0.0°	Φ 3: - 0.0°
WH: 0.000 KWH	SH: 0.000 KVAH	
QH: 0.000 KVARH	FREQ: 0.0 Hz	
1201		Change
20A	3Φ4W	Card
SEC: 2	CT: 1	PT: 1

The 'Change Card' display

6. The display will show the datalogging process by incrementing the data counter on the bottom right side of screen (under the REC display icon).
7. Each file can store up to 30,000 data points. When the number of data points reaches 30,000 the system will create a new file automatically. (For example, WTA01001.XLS will be replaced by WTA01002.XLS)
8. Press the REC key again to stop datalogging. The incrementing counter and the REC display icon will switch off.
9. Instructions are provided later in this User Guide regarding data exporting to a spreadsheet using a PC.

V12: 0.0 V	V1: 0.0 V	A1: 0.00 A
V23: 0.0 V	V2: 0.0 V	A2: 0.00 A
V31: 0.0 V	V3: 0.0 V	A3: 0.00 A
P1: - 0.000 KW	S1: 0.000 KVA	Q1: - 0.000 KVAR
P2: - 0.000 KW	S2: 0.000 KVA	Q2: - 0.000 KVAR
P3: - 0.000 KW	S3: 0.000 KVA	Q3: - 0.000 KVAR
PΣ - 0.000 KW	SΣ : 0.000 KVA	QΣ : - 0.000 KVAR
PF1: - 0.00	PF2: - 0.00	PF3: - 0.00
PFΣ : 0.00	PFH: 0.00	
Φ 1: - 0.0°	Φ 2: - 0.0°	Φ 3: - 0.0°
WH: 0.000 KWH	SH: 0.000 KVAH	
QH: 0.000 KVARH	FREQ: 0.0 Hz	
1201		REC
20A	3Φ4W	9
SEC: 2	CT: 1	PT: 1

The Datalogger Incrementing Counter display

5.12 – Data Hold Function

1. During a measurement, press the HOLD KEY once, the displayed readings will freeze and the display will show the “HOLD” icon on the bottom right side of the screen
2. Press the HOLD key again to release the display and return to the normal operating mode. The HOLD display icon will switch off

V12: 0.0 V	V1: 0.0 V	A1: 0.00 A
V23: 0.0 V	V2: 0.0 V	A2: 0.00 A
V31: 0.0 V	V3: 0.0 V	A3: 0.00 A
P1: - 0.000 KW	S1: 0.000 KVA	Q1: - 0.000 KVAR
P2: - 0.000 KW	S2: 0.000 KVA	Q2: - 0.000 KVAR
P3: - 0.000 KW	S3: 0.000 KVA	Q3: - 0.000 KVAR
PΣ - 0.000 KW	SΣ : 0.000 KVA	QΣ : - 0.000 KVAR
PF1: - 0.00	PF2: - 0.00	PF3: - 0.00
PFΣ : 0.00	PFH: 0.00	
Φ1: - 0.0°	Φ2: - 0.0°	Φ3: - 0.0°
WH: 0.000 KWH	SH: 0.000 KVAH	
QH: 0.000 KVARH	FREQ: 0.0 Hz	
1201		
20A	3Φ4W	SEC: 2 CT: 1 PT: 1
		HOLD

The HOLD display

5.13 – LCD Backlight Key

Press to turn the backlight ON or OFF. Note: Use of the backlight will place a higher burden on the battery power. The backlight should be turned off when using battery power and especially while datalogging.

5.14 – Low Battery Indication (LOW BAT)

When the LOW BAT indicator appears, replace the batteries as described in the Battery Replacement section of this manual. Use of weak batteries will compromise measurement accuracy and meter performance.

V12: 0.0 V	V1: 0.0 V	A1: 0.00 A
V23: 0.0 V	V2: 0.0 V	A2: 0.00 A
V31: 0.0 V	V3: 0.0 V	A3: 0.00 A
P1: - 0.000 KW	S1: 0.000 KVA	Q1: - 0.000 KVAR
P2: - 0.000 KW	S2: 0.000 KVA	Q2: - 0.000 KVAR
P3: - 0.000 KW	S3: 0.000 KVA	Q3: - 0.000 KVAR
PΣ - 0.000 KW	SΣ : 0.000 KVA	QΣ : - 0.000 KVAR
PF1: - 0.00	PF2: - 0.00	PF3: - 0.00
PFΣ : 0.00	PFH: 0.00	
Φ1: - 0.0°	Φ2: - 0.0°	Φ3: - 0.0°
WH: 0.000 KWH	SH: 0.000 KVAH	
QH: 0.000 KVARH	FREQ: 0.0 Hz	
1201		
20A	3Φ4W	SEC: 2 CT: 1
		LOWBAT
		PT: 1

Low Battery indication

5.15 Measurement Definitions

- V12, V23, V31 : Line Voltage
- V1, V2, V3 : Phase Voltage
- A1, A2, A3 : Line Current
- P1, P2, P3 : True Power of each phase (W)
- S1, S2, S3 : Apparent Power of each phase. (VA)
- Q1, Q2, Q3 : Reactive Power of each phase (VAR)
- $P\Sigma$: Total True Power (W)
- $S\Sigma$: Total Apparent Power (VA)
- $Q\Sigma$: Total Reactive Power (VAR)
- PF1, PF2, PF3 : Power Factor of each phase
- $PF\Sigma$: Total Power Factor
- PFH : Long Term Average Power Factor (WH/SH)
- $\phi 1, \phi 2, \phi 3$: Phase Angle of each phase
- WH : Watt Hour
- SH : Apparent Power Hour
- QH : Reactive Power Hour
- 1 ϕ 2W : One phase by two wires
- 1 ϕ 3W : One phase by three wires
- 3 ϕ 3W : Three phases by three wires
- 3 ϕ 4W : Three phases by four wires
- SEC : The sampling rate in seconds for the datalogger
- CT : Current transformer
- PT : Potential transformer
- Transient Reference :
- SDVP : Swell and Dip Voltage Percentage (used with Transient Reference Voltage)

5.16 – Reset Button

The Reset Button located on the right side of the meter allows the user to reboot the meter if the display or keypad is locked.

6.0 Maintenance



CAUTION: Remove test leads before opening the battery cover; Electrical Shock Hazard.

6.1 Cleaning



CAUTION: When cleaning, use only a dry cloth. Do not use liquids of any kind to clean the meter.

6.2 Battery Replacement

1. When the display shows the LOWBAT indicator, replace the batteries as soon as possible
2. Open the rear Battery Cover and remove the batteries
3. Replace the eight (8) batteries (1.5Vdc 'AA' batteries) and close the battery cover



You, as the end user, are legally bound (**EU Battery ordinance**) to return all used batteries, **disposal in the household garbage is prohibited!** You can hand over your used batteries / accumulators at collection points in your community or wherever batteries / accumulators are sold!

Disposal: Follow the valid legal stipulations in respect of the disposal of the device at the end of its lifecycle

7.0 SD Card

7.1 Download SD Card Data to PC

1. After a Datalogging session, remove the SD card from the SD card socket.
2. Plug the SD card into a PC SD card reader slot or into an SD card reader adaptor.
3. Power the computer and run spreadsheet software. Download the stored data file from the SD Card to the PC (file name examples: 3P401001.XLS, 1P201001.XLS, 1P301001.XLS, 3P301001.XLS).
4. The data files can be opened directly into a spreadsheet program.

Example Data File

1	A	B	C	D	E	F	G	H	I	J	K	L
2	Position	Date	Time	V12	Unit	V23	Unit	V31	Unit	V1	Unit	V2
3	0	2009/1/4	08:58:53	0	ACV	0	ACV	0	ACV	0	ACV	0
4	0	2009/1/4	08:58:55	0	ACV	0	ACV	0	ACV	0	ACV	0
5	0	2009/1/4	08:58:57	0	ACV	0	ACV	0	ACV	0	ACV	0
6	0	2009/1/4	08:58:59	0	ACV	0	ACV	0	ACV	0	ACV	0
7	0	2009/1/4	08:59:01	0	ACV	0	ACV	0	ACV	0	ACV	0
8	0	2009/1/4	08:59:03	0	ACV	0	ACV	0	ACV	0	ACV	0
9	0	2009/1/4	08:59:05	0	ACV	0	ACV	0	ACV	0	ACV	0
10	0	2009/1/4	08:59:07	0	ACV	0	ACV	0	ACV	0	ACV	0
11	0	2009/1/4	08:59:09	0	ACV	0	ACV	0	ACV	0	ACV	0
12	0	2009/1/4	08:59:11	0	ACV	0	ACV	0	ACV	0	ACV	0
13												

Example Screen

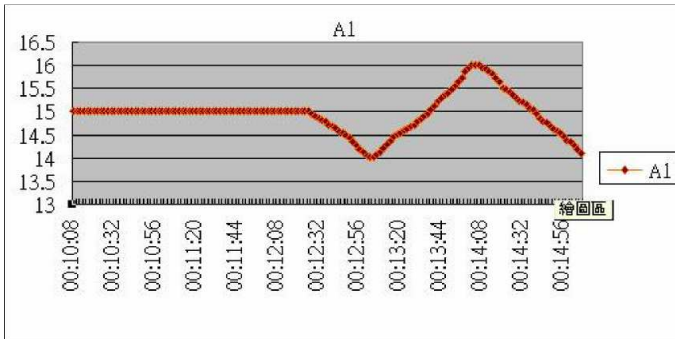

Graphic

Copyright © 2012 Extech Instruments Corporation (a FLIR company)

All rights reserved including the right of reproduction in whole or in part in any form.

ISO-9001 Certified

www.extech.com