

Power supply unit, dip coated - QUINT-PS/ 1AC/24DC/ 5/ CO - 2320908

Please be informed that the data shown in this PDF Document is generated from our Online Catalog. Please find the complete data in the user's documentation. Our General Terms of Use for Downloads are valid (<http://download.phoenixcontact.com>)



Primary-switched QUINT power supply for DIN rail mounting, input: 1-phase, output: 24 V DC/5 A, dip-coated PCB, with integrated SFB (selective fuse breaking) technology, including mounted universal DIN rail adapter UTA 107/30

Product Description

QUINT POWER power supply units – maximum system availability thanks to SFB technology
 The new generation of QUINT POWER compact dip-coated power supply units with ATEX approval meet standard EN 60079-15 and may be installed within potentially explosive areas in which category 3G operating equipment is required (# II 3G). They are also suitable for use in Class I, Division 2, Groups A, B, C, D. For the first time ever, even standard circuit breakers can be tripped reliably and quickly with SFB (selective fuse breaking) technology and 6 times the nominal current for 12 ms. Faulty current paths are switched off selectively, the fault is located, and important system parts remain in operation. Comprehensive diagnostics are provided through constant monitoring of the output voltage and output current. This preventive function monitoring visualizes critical operating states and indicates them to the controller before errors can occur.

Product Features

- For maximum system availability
- Reliable starting of difficult loads with the static POWER BOOST power reserve with up to 1.5 times the nominal current permanently
- Fast tripping of standard circuit breakers with dynamic power reserve SFB (selective fuse breaking) technology with up to 6 times the nominal current for 12 ms
- Preventive function monitoring
- Optimum protection with dip coating for 100% humidity



Key commercial data

package_quantity	1
GTIN	4046356520010

Technical data

Dimensions

Width	40 mm
Height	130 mm
Depth	125 mm
Width with alternative assembly	122 mm
Height with alternative assembly	130 mm
Depth with alternative assembly	43 mm

Power supply unit, dip coated - QUINT-PS/ 1AC/24DC/ 5/ CO - 2320908

Technical data

Ambient conditions

Degree of protection	IP20
Ambient temperature (operation)	-40 °C ... 70 °C (ATEX/IECEX: -25°C ... +60°C)
Ambient temperature (storage/transport)	-40 °C ... 85 °C
Max. permissible relative humidity (operation)	100 % (at 25 °C, no condensation)
Noise immunity	EN 61000-6-2:2005

Input data

Nominal input voltage range	100 V AC ... 240 V AC
Input voltage range AC	85 V AC ... 264 V AC
Input voltage range DC	90 V DC ... 410 V DC + 5 % (UL 508: ≤ 250 V DC)
Short-term input voltage	300 V AC
AC frequency range	45 Hz ... 65 Hz
Frequency range DC	0 Hz
Current consumption	1.2 A (120 V AC)
Current consumption	0.6 A (230 V AC)
Inrush surge current	< 15 A (typical)
Power failure bypass	> 25 ms (120 V AC)
Power failure bypass	> 25 ms (230 V AC)
Input fuse	5 A (slow-blow, internal)
Choice of suitable fuses	6 A ... 16 A (Characteristics B, C, D, K)
Type of protection	Transient surge protection
Protective circuit/component	Varistor

Output data

Nominal output voltage	24 V DC ±1%
Setting range of the output voltage	18 V DC ... 29.5 V DC (> 24 V constant capacity)
Output current	5 A (-25°C ... 60°C, U _{OUT} = 24 V DC)
Output current	7.5 A (U _{in} ≥ 100 V AC)
Output current	30 A (SFB technology, 12 ms)
Output current	7.5 A (with POWER BOOST, -25°C ... 40°C permanently, U _{OUT} = 24 V DC)
Magnetic fuse tripping	B2
Magnetic fuse tripping	B4
Magnetic fuse tripping	C2
Derating	60 °C ... 70 °C (2.5%/K)
Connection in parallel	Yes, for redundancy and increased capacity
Connection in series	Yes
Control deviation	< 1 % (change in load, static 10% ... 90%)
Control deviation	< 2 % (change in load, dynamic 10% ... 90%)
Control deviation	< 0.1 % (change in input voltage ±10%)
Residual ripple	< 40 mV _{PP} (with nominal values)

Power supply unit, dip coated - QUINT-PS/ 1AC/24DC/ 5/ CO - 2320908

Technical data

Output data

Maximum power dissipation NO-Load	3 W
Power loss nominal load max.	15 W

General

Net weight	0.7 kg
Efficiency	> 90 % (for 230 V AC and nominal values)
Insulation voltage input/output	4 kV AC (type test)
Insulation voltage input/output	2 kV AC (routine test)
Protection class	I
MTBF (IEC 61709, SN 29500)	> 635000 h
Mounting position	horizontal DIN rail NS 35, EN 60715
Assembly instructions	Alignable: 5 mm horizontally, 15 mm next to active components, 50 mm vertically
Electromagnetic compatibility	Conformance with EMC Directive 2004/108/EC
Noise emission	EN 50081-2
Low Voltage Directive	Conformance with LV directive 2006/95/EC
ATEX	# II 3 G Ex nA nC IIC T4 Gc
ATEX	TÜV 11 ATEX 555674 X
IECEX	Ex nA nC IIC T4 Gc
IECEX	IECEX TUN 11.0002X
Standard – Electrical equipment of machines	EN 60204
Standard - Electrical safety	IEC 60950-1/VDE 0805 (SELV)
Shipbuilding approval	Germanischer Lloyd (EMC 2)
Standard – Electronic equipment for use in electrical power installations and their assembly into electrical power installations	EN 50178/VDE 0160 (PELV)
Standard – Safety extra-low voltage	IEC 60950-1 (SELV) and EN 60204 (PELV)
Standard - Safe isolation	DIN VDE 0100-410
Standard - Safe isolation	DIN VDE 0106-1010
Standard – Protection against electric shock	DIN 57100-410
Standard – Protection against shock currents, basic requirements for protective separation in electrical equipment	DIN VDE 0106-101
Standard – Limitation of mains harmonic currents	EN 61000-3-2
Standard - Equipment safety	BG (design tested)
Standard - Approval for medical use	IEC 60601
Approval - requirement of the semiconductor industry with regard to mains voltage dips	SEMI F47-0706 Compliance Certificate; EN 61000-4-11
Information technology equipment - safety (CB scheme)	IEC 60950 (2 nd Edition)
UL approvals	UL/C-UL listed UL 508
UL approvals	UL/C-UL Recognized UL 60950
UL approvals	UL ANSI/ISA-12.12.01 Class I, Division 2, Groups A, B, C, D (Hazardous Location)

Power supply unit, dip coated - QUINT-PS/ 1AC/24DC/ 5/ CO - 2320908

Technical data

General

Surge voltage category	III
DeviceNet approval	DeviceNet™ Power Supply Conformance Tested

Connection data, input

Connection method	Pluggable screw connection
Conductor cross section solid min.	0.2 mm ²
Conductor cross section solid max.	2.5 mm ²
Conductor cross section stranded min.	0.2 mm ²
Conductor cross section stranded max.	2.5 mm ²
Conductor cross section AWG/kcmil min.	20
Conductor cross section AWG/kcmil max	12
Stripping length	7 mm
Screw thread	M3

Connection data, output

Connection method	Pluggable screw connection
Conductor cross section solid min.	0.2 mm ²
Conductor cross section solid max.	2.5 mm ²
Conductor cross section stranded min.	0.2 mm ²
Conductor cross section stranded max.	2.5 mm ²
Conductor cross section AWG/kcmil min.	20
Conductor cross section AWG/kcmil max	12
Stripping length	7 mm

Signaling

Output name	DC OK active
Output description	$U_{OUT} > 0.9 \times U_N$: High signal
Maximum inrush current	20 mA (short-circuit resistant)
Continuous load current	≤ 20 mA
Status display	$U_{OUT} > 0.9 \times U_N$: "DC OK" LED green
Note on status display	$U_{OUT} < 0.9 \times U_N$: Flashing "DC OK" LED
Note on status display	$I_{OUT} < I_N$: LED ON
Conductor cross section solid min.	0.2 mm ²
Conductor cross section solid max.	2.5 mm ²
Conductor cross section stranded min.	0.2 mm ²
Conductor cross section stranded max.	2.5 mm ²
Conductor cross section AWG/kcmil min.	20
Conductor cross section AWG/kcmil max	12
Tightening torque, min	0.5 Nm
Tightening torque max	0.6 Nm
Screw thread	M3

Power supply unit, dip coated - QUINT-PS/ 1AC/24DC/ 5/ CO - 2320908

Technical data

Signaling

Output name	DC OK floating
Output description	Relay contact, $U_{OUT} > 0.9 \times U_N$: Contact closed
Maximum switching voltage	30 V AC
Maximum switching voltage	24 V DC
Maximum inrush current	0.5 A (ATEX/IECEX: Ohmic loads only)
Maximum inrush current	1 A (ATEX/IECEX: Ohmic loads only)
Continuous load current	1 A
Status display	$U_{OUT} > 0.9 \times U_N$: "DC OK" LED green
Note on status display	$U_{OUT} < 0.9 \times U_N$: Flashing "DC OK" LED
Output name	POWER BOOST, active
Output description	$I_{OUT} < I_N$: High signal
Output voltage	+ 24 V DC
Maximum inrush current	20 mA (short-circuit resistant)
Continuous load current	≤ 20 mA
Status display	$I_{OUT} > I_N$: LED "BOOST" yellow

classifications

eCl@ss

eCl@ss 4.0	27040702
eCl@ss 4.1	27040702
eCl@ss 5.0	27049002
eCl@ss 5.1	27049002
eCl@ss 6.0	27049002
eCl@ss 7.0	27049002
eCl@ss 8.0	27049002

ETIM

ETIM 4.0	EC000599
ETIM 5.0	EC002540

UNSPSC

UNSPSC 6.01	30211502
UNSPSC 7.0901	39121004
UNSPSC 11	39121004
UNSPSC 12.01	39121004
UNSPSC 13.2	39121004

Power supply unit, dip coated - QUINT-PS/ 1AC/24DC/ 5/ CO - 2320908

approvals

IECEEx / ATEX / IECEEx / ATEX / UL Listed / cUL Listed / cULus Listed / CSA / UL Recognized / UL Listed / cUL Recognized / GOST / GL / IECEE CB Scheme / CSA / UL Recognized / UL Listed / cUL Recognized / GOST / GL / IECEE CB Scheme / Bauartgeprüft / Bauartgeprüft / cULus Recognized /

Approval details

IECEEx
ATEX
UL Listed
cUL Listed
cULus Listed
CSA
UL Recognized

Power supply unit, dip coated - QUINT-PS/ 1AC/24DC/ 5/ CO - 2320908

approvals

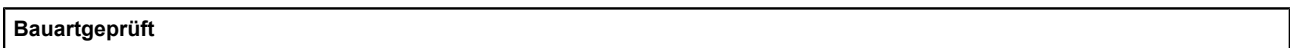
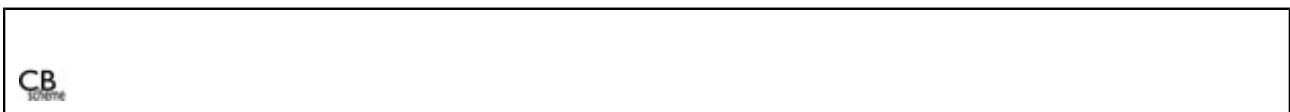
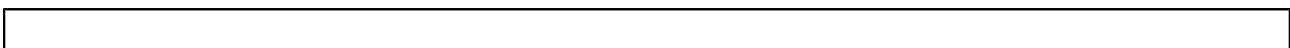
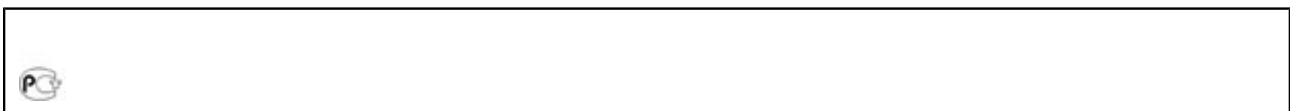
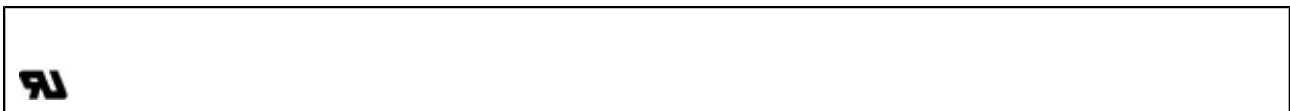
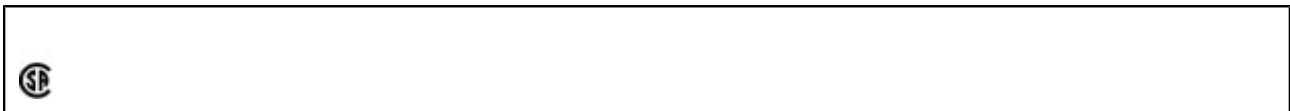
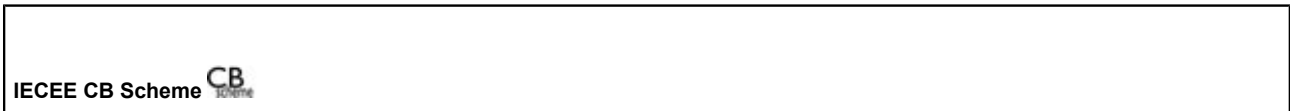
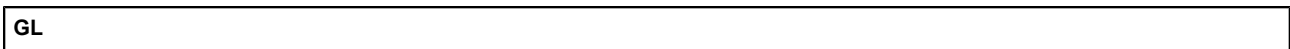

Power supply unit, dip coated - QUINT-PS/ 1AC/24DC/ 5/ CO - 2320908

approvals

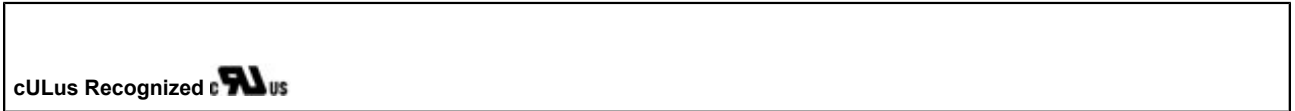

accessories

Assembly adapter

UTA 107/30 - 2320089



UWA 182/52 - 2938235

QUINT-PS-ADAPTERS7/1 - 2938196



Fan

QUINT-PS/FAN/4 - 2320076



Power supply unit, dip coated - QUINT-PS/ 1AC/24DC/ 5/ CO - 2320908

accessories

Redundancy module

QUINT-DIODE/12-24DC/2X20/1X40 - 2320157



QUINT-ORING/24DC/2X10/1X20 - 2320173



TRIO-DIODE/12-24DC/2X10/1X20 - 2866514



Thermomagnetic device circuit breakers

CB TM1 1A SFB P - 2800836



CB TM1 2A SFB P - 2800837



Drawings

Power supply unit, dip coated - QUINT-PS/ 1AC/24DC/ 5/ CO - 2320908

Block diagram

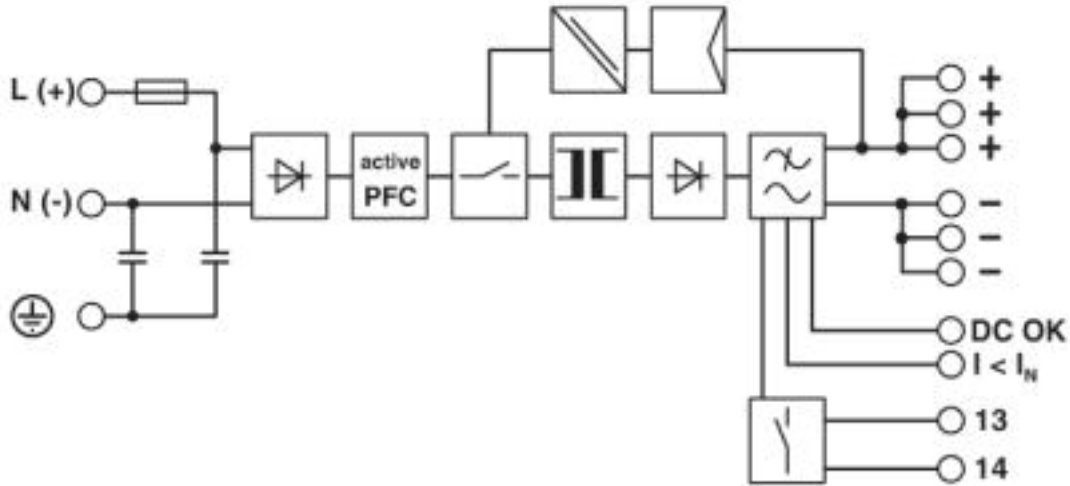

© Phoenix Contact 2013 - all rights reserved
<http://www.phoenixcontact.com>