

Preset counters, electronic

LED preset counters	Multifunctional – pulse, frequency, time – 65 kHz, 2 presets (AC+DC)	Codix 560
----------------------------	---	------------------



With its automatic help texts, clearly and legibly displayed on 14 LED segments, the Codix 560 preset counter takes the user effortlessly through the programming. The large user-friendly front keys can be operated even when wearing gloves.

The 14 mm high LED display ensures easy reading even from a long distance and in poor lighting conditions.

New: now available also with RS232/485 interface and MODBUS and CR/LF protocol



DC 10 ... 30V Power supply	AC 100 ... 240V Temperature range	-20° + 65° Temperature range	000000 DIN 96 x 48 DIN front bezel	PROG Menu-driven programming	IP65 High protection level	max. 65 kHz High count frequency	Hz Multifunctional	t/Hz HRA Frequency display with HRA	POSITION Position display	A..Z* LEDs 14 segment LED	
Batch Batch counter	Σ Total counter	RS 232 485 Optional interface									

Multifunctional

- Counter, tachometer, timer and position display in one device.
- Can be used as preset counter, batch counter or total counter.
- 2 relays (change-over).
- Many different count modes.
- Scalable display.
- Set value, step or tracking preset.
- Multi-range power supply for AC or DC.
- Readable or configurable via RS232/485 interface via MODBUS or CR/LF protocol.
- Allows direct connection of a large display or printer.

User-friendly

- Automatic help texts, displayed in German and English.
- 14-segment LED for improved text representation.
- Status display of the presets.
- 3 predefined parameters.
- Tracking presets eliminate the need for reprogramming of the pre-signal.
- Minimum installation depth.
- 4-stage RESET modes.
- 3-stage keypad locking.
- Suitable for installation in mosaic systems.

Order code	6.560	. 010	. XXX
	a	b	c

- | | | | |
|--|--|---|--|
| a Power supply
0 = 100 ... 240 V AC, ±10 % ¹⁾
3 = 10 ... 30 V DC ¹⁾ | b Input trigger levels
0 = Standard level (HTL) ¹⁾
A = 4...30 V DC level | c Interface (optional)
0 = None
5 = RS232 (MODBUS or CR/LF)
7 = RS485 (MODBUS or CR/LF) | Delivery specification
• Preset counter
• Mounting clip
• Instruction manual |
|--|--|---|--|

Accessories	Dimensions in mm [inch]	Order no.
Mounting frame with cut-out 92 x 45 [3.62 x 1.77]	for snap-on mounting on 35 [1.38] top-hat DIN rail, for counters 96 x 48 [3.78 x 1.89]	grey G300005

Suitable gaskets as well as further accessories can be found in the accessories section or in the accessories area of our website at: www.kuebler.com/accessories.

1) Stock types

Preset counters, electronic

LED preset counters Multifunctional – pulse, frequency, time – 65 kHz, 2 presets (AC+DC) Codix 560

Technical data

General technical data	
Display	6-digit red 14 segment LED display, 14 mm [0.55] high
Operating temperature	-20°C ... +65°C [-4°F ... +149°F] (non-condensing)
Storage temperature	-25°C ... +75°C [-13°F ... +167°F]
Relative humidity at +40°C [+104°F]	RH 93 % (non-condensing)
Altitude	up to 2000 m [6562']

Electrical characteristics	
Power supply	AC 100 ... 240 V AC, ±10 % max. 11 VA, 50/60 Hz DC 10 ... 30 V, max. 5.5 W
External fuse protection	230 V AC T 0.1 A 10 ... 30 V DC T 0.25 A
Data retention	> 10 years, EEPROM
Response time of the frequency meter	100 / 600 ms (details s. instruction manual)
Input modes	<p>pulse counters count direction (cnt.dir), difference (up.dn), addition A+B (up.up), phase discriminator x1, x2, x4 (quad, quad x2, quad x4), ratio (A/B), ratio in % ((A-B)/A x 100 %)</p> <p>frequency meter A, A-B, A+B quad, A/B, (A-B)/A x 100 %</p> <p>timer 4 start modes: FrErUn, Auto, InpA.InpB., InpB.InpB.</p>
Sensor power supply	AC supply 24 V DC ±15 %, 80 mA DC supply max. 80 mA, external power supply is connected through
EMC standards	EN 55011 class B, EN 61000-6-2, EN 61000-6-3
Device safety	designed to protection class application area EN 61010 part 1 2 pollution level 2
UL approval	file E128604

Mechanical characteristics	
Protection	IP65 (from the front)
Weight	approx. 180 g [6.35 oz]

Inputs	
Count inputs	A and B
Polarity of the inputs	programmable for all inputs in common, NPN/PNP
Input resistance	5 kΩ
Count frequency	<p>pulse counters max. 55 kHz</p> <p>tachometers max. 65 kHz</p> <p>can be damped to 30 Hz (mechanical contacts) (details s. instruction manual)</p>
Control / Reset input	MPI 1 and MPI 2, Lock, Gate, Reset
Min pulse duration of the inputs	10 ms / 1 ms
Switching levels with AC supply	<p>HTL-level: LOW: 0 ... 4 V DC HIGH: 12 ... 30 V DC</p> <p>4 ... 30 V DC: LOW: 0 ... 2 V DC HIGH: 3.5 ... 30 V DC</p>
Switching levels with DC supply	<p>HTL-level: LOW: 0 ... 0.2 x U_B HIGH: 0.6 x U_B ... 30 V DC</p> <p>4 ... 30 V DC: LOW: 0 ... 2 V DC HIGH: 3.5 ... 30 V DC</p>
Pulse shape	variable, Schmitt-Trigger characteristics

Outputs	
Switching voltage	max. 250 V AC / 150 V DC
Switching current	max. 3 A AC / DC min. 30 mA DC
Switching capacity	max. 750 VA / 90 W
Output 1 + 2	<p>mech. service life (switching cycles) 2 x 10⁷</p> <p>N° of switching cycles at 3 A / 250 V AC 5 x 10⁴</p> <p>N° of switching cycles at 3 A / 30 V DC 5 x 10⁴</p> <p>relay with changeover contact</p>
Reaction time of the outputs (pulse / time)	13 ms (details s. instruction manual)

Optional interface MODBUS and CR/LF	
Count frequency	max. 45 kHz (details s. instruction manual)
Interface	RS232, RS485
Baud rate	9600
Device address	1 ... 99, programmable

Terminal assignment

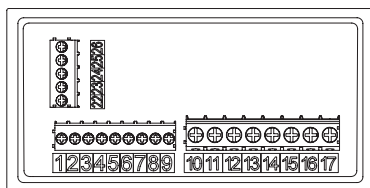

Pin	RS232 (optional)	Pin	RS485 (optional)
22	GND	22	-
23	RXD	23	DO
24	TXD	24	DI
25	-	25	-
26	-	26	-

Pin	Signal and control inputs
1	INP A (Signal input A)
2	INP B (Signal input B)
3	RESET (Reset input)
4	LOCK (Keypad lock)
5	GATE (Gate input)
6	MPI 1 (User input 1)
7	MPI 2 (User input 2)
8	Sensor power supply AC: 24 V DC/80 mA DC: U _B connected through
9	Shared connection for signal and control inputs GND (0 VDC)

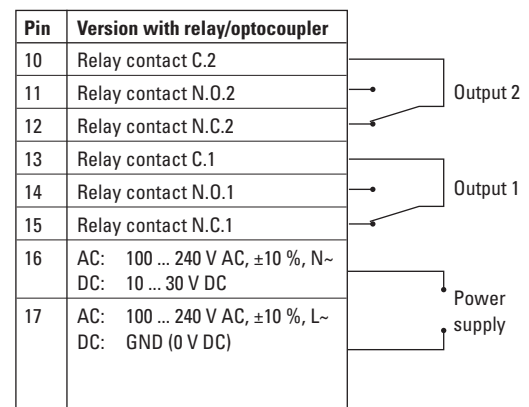

Preset counters, electronic

LED preset counters

Multifunctional – pulse, frequency, time – 65 kHz, 2 presets (AC+DC)

Codix 560

Pulse counter

Functions / count modes

- Count with direction mode
- Difference mode
- Quadrature mode quad / quad2 / quad4
- Add, Sub, automatic reset
- 2-input adding mode A+B
- Ratio measurement A/B
- Multi-range power supply for AC or DC
- Percentage difference measurement $(A-B)/A \times 100\%$
- Batch counting
- Totalizer (Overall total)
- Multiplication and division factor (up to 99.9999)
- Set value
- Step or tracking preset

Application examples

CountDir + Add

Roller shutter door with automatic shut-off

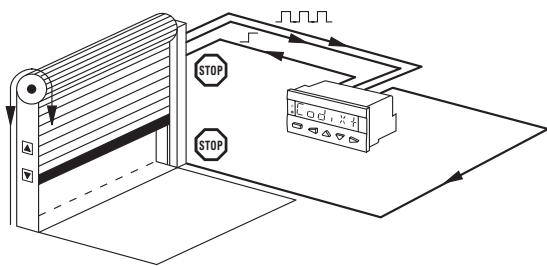

Quad + Add

Running direction and position on milling machines, Limit switch monitoring

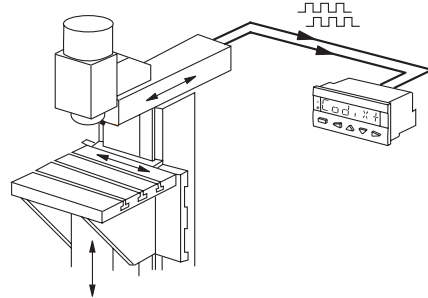

UpDown + Add

Automatic subtraction of faulty or reject parts from the total piece count

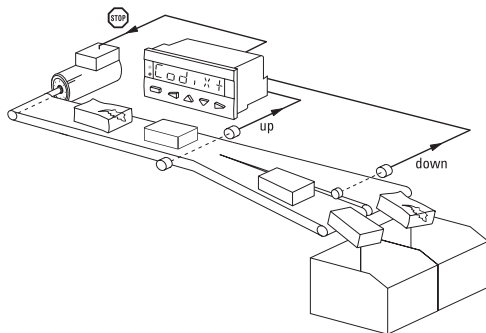

CountDir + Batch

Logging of piece numbers and packing units plus control of replenishment of packing cartons

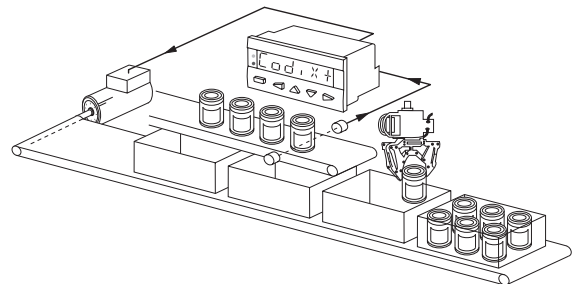

UpUp + Add

Adding up of two parallel or staggered production lines

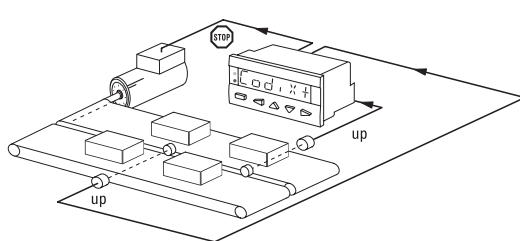

Quad + Add tot

Cut-to-length with overall total count and control of the machine

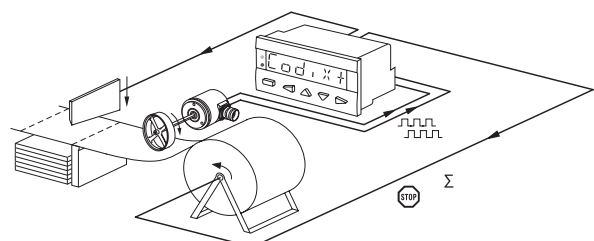

Preset counters, electronic

LED preset counters **Multifunctional – pulse, frequency, time – 65 kHz, 2 presets (AC+DC)** **Codix 560**

Frequency meter (tachometer)

Functions / count modes

- A
- A – B
- A + B
- A / B
- $(A - B) / A \times 100\%$ (percentage display)
- Quad (phase discriminator with recognition of direction)
- Averaging
- Start delay
- 2nd tacho input
- Gate input
- Multiplication and division factor (up to 99.9999)

Application examples

A – B

Synchro monitoring and control of two conveyor belts

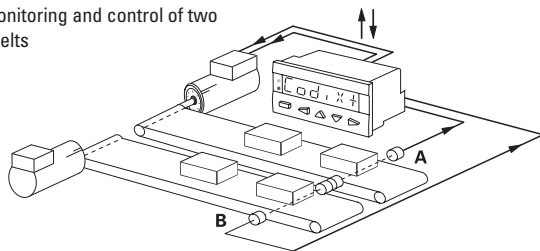

Quad

Speed regulation with indication of direction

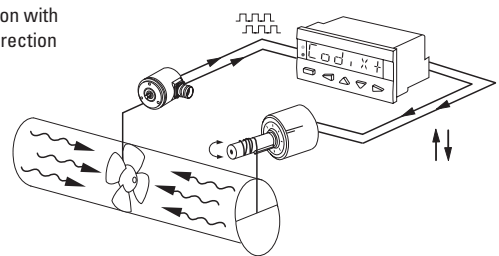

A/B

Ratio measurement

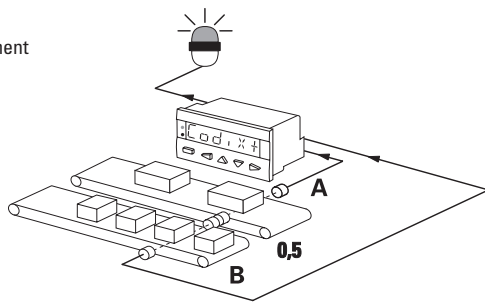

$(A-B)/A$ [%]

Ratio measurement, e.g. for speed alignment

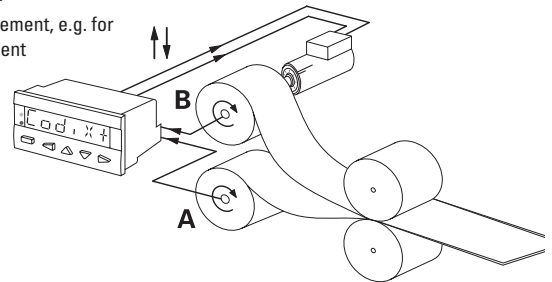

Time and hours-run meter (timer)

Functions / count modes

- FrErUn (control via gate input)
- Auto (start via reset, stop at preset)
- InpB.InpB (start with first edge at InpB., stop with second edge InpB.)
- InpA. InpB (start with InpA., stop with InpB.)
- Totalizer (overall total)
- Batch counting
- Set value
- Step or tracking preset

Application examples

InpB. InpB

Interval measurement

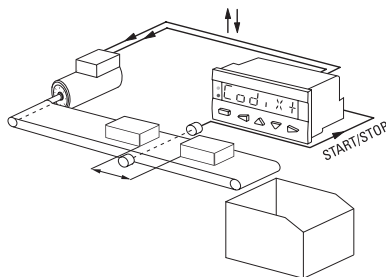

FrErUn

Measurement of overall time from switching on the conveyor belt till switching off

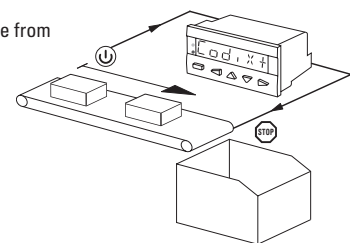

InpA. InpB

Run-time measurement

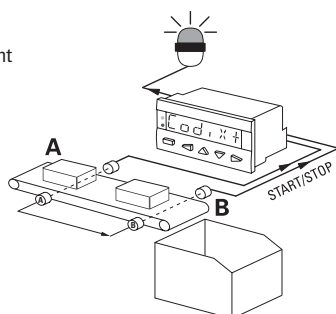

Auto

Time-controlled production line

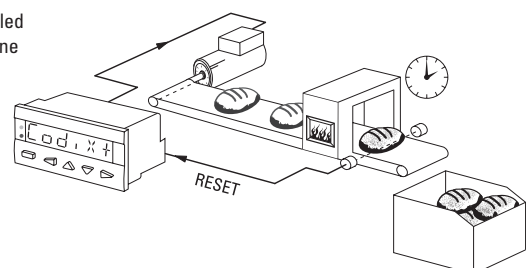

Preset counters, electronic

LED preset counters

Multifunctional – pulse, frequency, time – 65 kHz, 2 presets (AC+DC)

Codix 560

RS232 / RS485 interface (optional)

For connecting the counter to a PC, a PLC, a large display or a printer – for reading-out data or configuring the device.

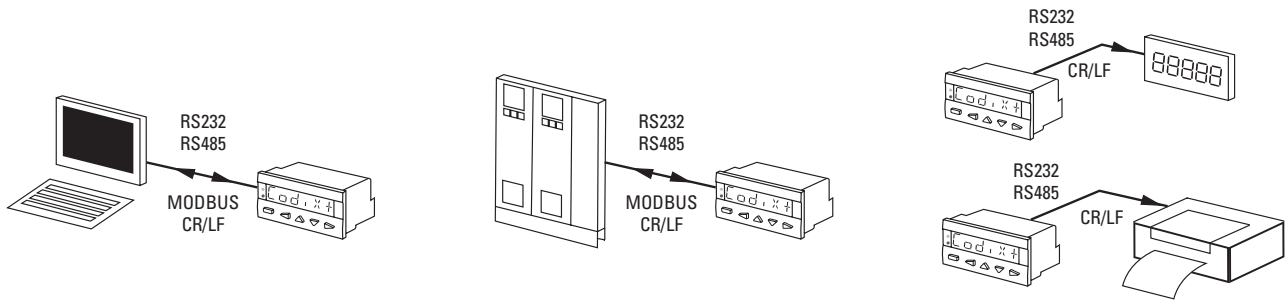

Dimensions

Dimensions in mm [inch]

