

## Operating Manual

# Universal Digital panel meter MINIPAN 300

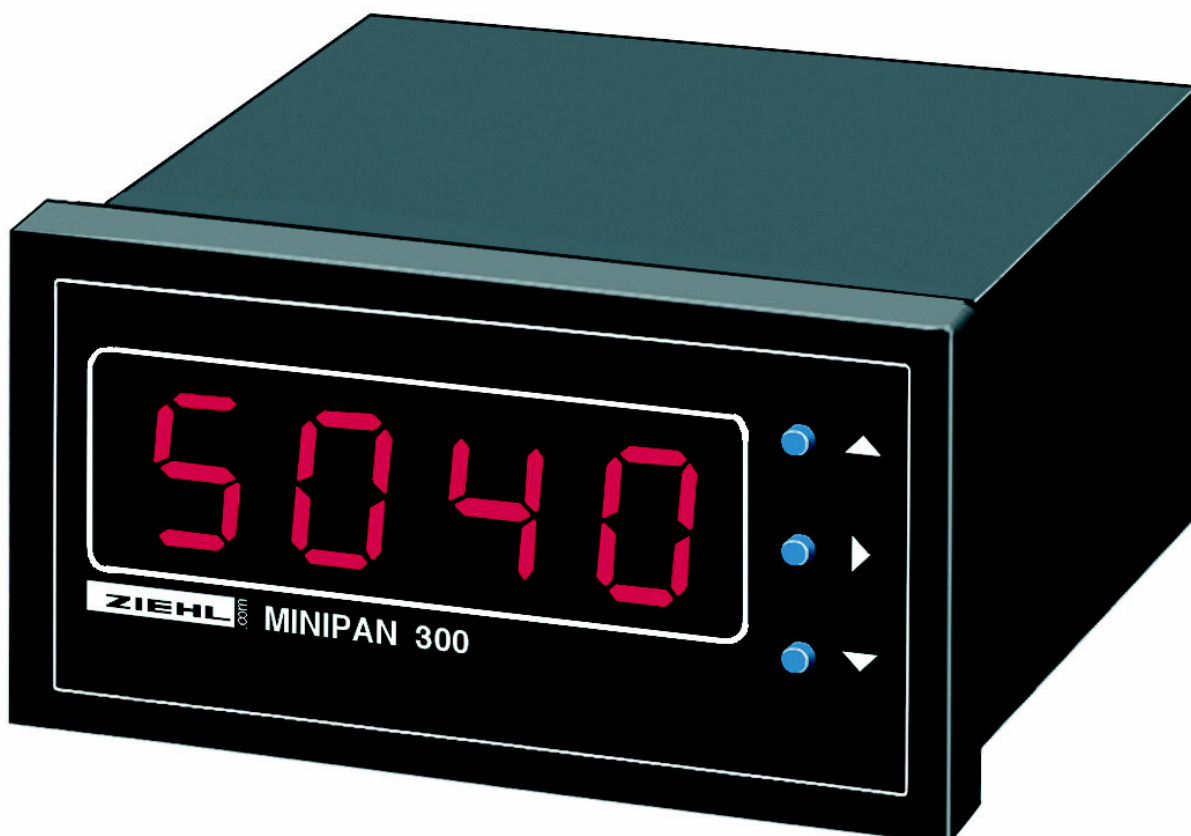

# Contents

# Page

Application and short description .....	2
Overview of the functions.....	2
Connection plan.....	3
Display- and operating elements .....	3
Important information's .....	4
Installation.....	4
Starting .....	5
Setting of parameters .....	5
Display mode .....	5
Display mode .....	5
Parameter setting mode .....	5
Display codes .....	8
Factory setting .....	9
Operation AC / DC.....	9
Operation Pt 100 .....	10
Error search and measures .....	10
Technical data .....	11
Housing.....	12

## Application and short description

With its 4 digit, 14 mm high display, Digital Panel meters of MINIPAN 300- series allow the accurate display of different values in the range -1999 ... +9999.

Only 3 designs cover the measuring of DC voltage and current, AC voltage and current and temperature with Pt 100- sensors (RTD).

The display can be easily programmed by the customer (e.g. input 0-10 V --> display 0-350.0 ms or AC 0-1 A ---> 0- 400.0 A

With the built-in universal power supply AC/DC 24-240 V it is especially versatile.

## Overview of functions and connection plan

Easy programming with 3 buttons:

- Display (scaling, decimal-point)
- Display of MIN- and MAX-values
- Delay for display at unstable signals
- Code-lock against manipulation of settings
- Terminals pluggable
- Face-Plate 36 x 72 mm

### Inputs DC-Meter:

- Measuring of current with external shunt max. 300 mV
- 1 A for direct measuring of current
- 0/4-20 mA for standard signals
- 0-10 V for standard-signals
- 100/500 V switch able

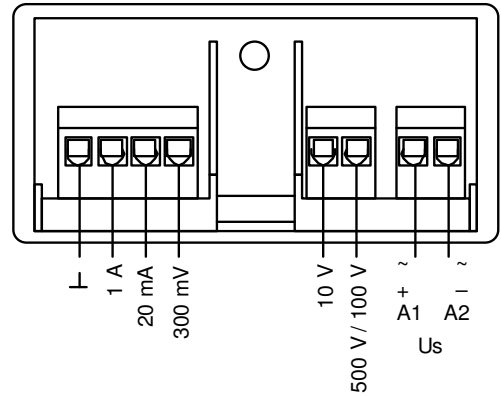

### Inputs AC-Meter:

- 500 V
- 50 V
- 10 V
- Measuring of current with external shunt max. 150 mV
- 1 A for direct measuring of current or with external transformer

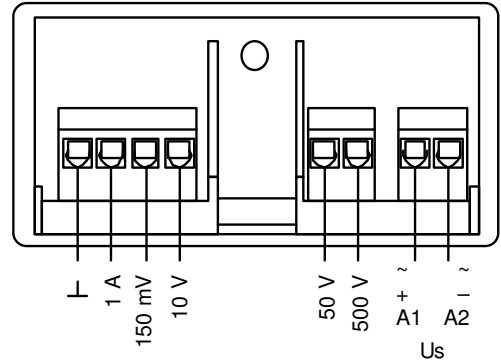

### Measuring of Temperature Pt 100 (RTD)

- Pt 100 in 2- or 3-wire connection
- Measuring Range -199,9 ... +850,0 °C
- Resolution 0,1 °C
- Display in °C or °F

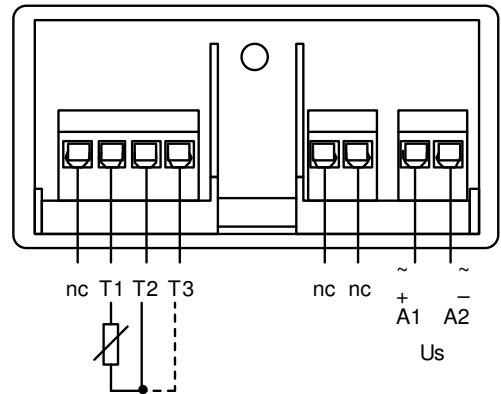

## Display and operating elements

1. Digital display with 4 digits
2. Button "Up"
3. Button "Set/Reset"
4. Button "Down"
5. Decimal point behind last digit:
  - off = display mode (measured values)
  - on = menu mode, select the menu items
  - blinking = parameter setting mode

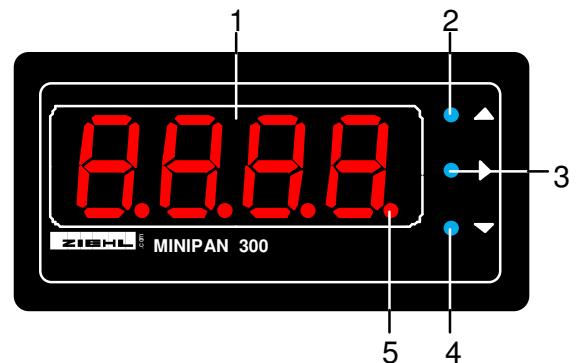

## Important information's

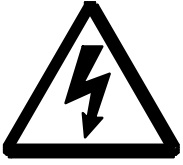

### **ATTENTION**

**Dangerous electrical voltage!**

**May lead to electrical shock and burn.**

**Before beginning of work switch unit and equipment free of voltage.**

Only let persons work with the equipment who are familiar with installation, start and use and who have appropriate qualification corresponding to their function. They must observe the contents of the instructions manual, the information which are written on the equipment and the relevant security instructions for the setting up and the use of electrical units.

The equipments are built according to DIN / EN and checked and leave the plant according to security in perfect condition.

If, in any case the information in the instructions manual is not sufficient, please contact our company or the responsible representative.

Instead of the industrial norms and regulations written in this instructions manual valid for Europe, you must observe the valid and relevant regulations of the corresponding country.



The **measuring inputs** is are insulated from supply-voltage but not from each other. **Connect one input only!**

### **Universal power supply.**

The device has got a universal power supply, that is suitable for DC- and AC-voltages. Before connecting the device to supply-voltage make sure that the connected voltage corresponds with the voltage on the type plate on the device.

## Assembly

Slide-in the MINIPAN 300 (1) into the prepared panel-cut-out ( $33^{+0,6} \times 68^{+0,7}$  mm) from the front side.

Slide the holding clamp (2) over the screw from the backside.

Screw on the knurled nut (3).

Ensure a right angle between holding clamp and panel.

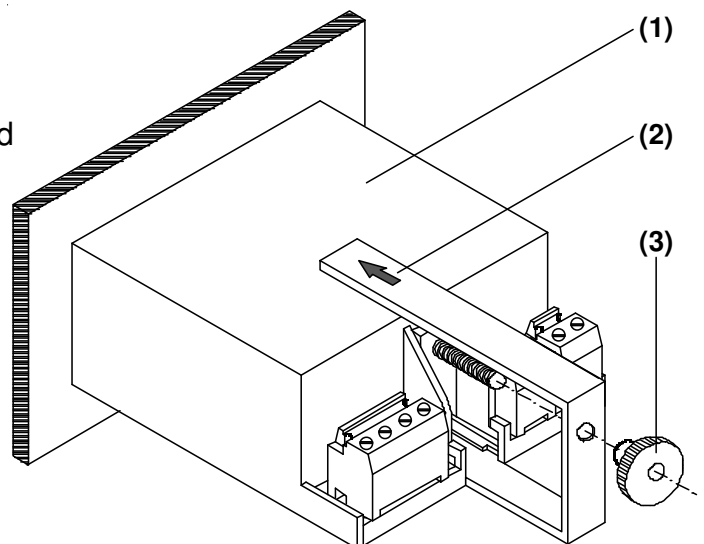

## Putting into Operation

Connect supply-voltage  $U_s$ .

Connect signal to measuring input. **Connect one input only!**

### Setting of Parameters:

Decimal point behind last digit:

off = display mode (measured values)

on = menu mode, select the menu items

blinking = parameter setting mode

### **Display Mode**

Display of actual measured value.

#### Function buttons Up/Down

Push short Change to menu mode, selection of menu item

Push for > 2 s Display of stored MIN- or MAX- values

#### Function of button Set /Reset

Push short no function

Push for > 2 s Reset of MIN- or MAX-value (with Min- or Max-button pushed simultaneously)

Push for > 10 s Display of software-version

### **Menu Mode** (Decimal point behind last digit ON)

Selection of the menu items for changing the parameters.

#### Function buttons Up/Down

Push short Selection of menu item; Change into display mode

#### Function Taste Set/Reset

Push short Change into parameter setting mode

### **Parameter setting mode** (Decimal point behind the last digit FLASHES)

#### Function buttons Up/Down

Push short/long Adjustment of parameter value (slow/fast)

#### Function button Set/Reset

Push short Storage of setting and choice of next parameter.  
Change into menu mode after the last parameter

### Parametrizing of Input / Measuring Range

Select menu item with Up/Down until display  $I_{nPU}$  and measuring range alternate.

Change into parametrizing mode with Set and select measuring range with Up/Down.

Confirm and change to next menu with Set.

When changing measuring range parameters for scaling the display are set to:

$I_{nLo} = 0\%$ ,  $I_{nHi} = 100\%$  of measuring range,  $d_i L_i = 0$ ,  $d_i H_i = 5000$  und  $dP = 0000$ .

### Scaling the Display

Select menu item with Up/Down until display  $S_cRL$  and mode (AUTO or USER) alternate.

Change into parametrizing mode with Set and select mode with Up/Down.

AUTO: Display = measured signal without scaling.

USER: Range of input-signal and range of display can be set by the user. The range of the input-signal must be within the measuring range.

Examples:

	I nPU	ScAL	I nLo	I nHi	d, Lo	d, Hi	dP
Input 0..10 V Display 30..100 %	10	USEr	0.00	10.00	30	100	0000.
Input 4..20 mA Display 0..100 %	4-20	USEr	4.00	20.00	0	100	0000.
Input 0..20 mA Display 50.0..500.0	0-20	USEr	0.00	20.00	500	5000	000.0
Input 10..90 V Display 50.0..500.0	100	USEr	10.0	90.0	500	5000	000.0
Input 0-60 mV Display 0,0..30.0	300	USEr	0	60	0	300	000.0
Input 2..5 V Display -50.0..100.0	10	USEr	2.00	5.00	-500	1000	000.0

Confirm and change to next menu with Set.

Delay of Display (recommended at unstable signals)

Select menu item with Up/Down until display  $\text{dd, 5}$  and programmed value alternate.

Change into parametrizing mode with Set and set delay of display with Up/Down.

Now the measured value will be written into the display every 0,1 ... 2 s.

Confirm and change to next menu with Set.

Fixed Digits (recommended when measured signal is very unstable or changing rapidly)

Select menu item with Up/Down until F and the fixed digits blinking are displayed. When no fixed digit is programmed, the last 2 digits are dark.

Set the fixed digits:

F, no

F, 0 last digit fixed (0)

F, 00 last digit fixed (00)

These digits display 0, independent from measured value.

Confirm and change to next menu with Set.

Code-lock

Select menu item with Up/Down until display  $\text{CodE}$  programmed state alternate.

Here the parameters can be protected by activating the code-lock. After pushing Set,  $P, n$  is displayed. Change to  $P, n 504$  with buttons Up/Down (factory setting). After pushing Set the code-lock can be activated or de-activated. After pushing Set again, an individual  $P, n$

Can be selected (write down)

With activated code-lock, all parameters can be seen but not changed any more.

In case of problems with the code-lock (forgotten  $P, n$ ), the lock can be switched off and the  $P, n$  can be set back to 504, by pushing the button Set/Reset while connecting the device to supply voltage until  $\text{CodE} / \text{oFF}$  is displayed.

### Line-Resistance at version for Pt 100-sensors (RTD):

Select menu item with Up/Down until display  $L-R$  and programmed parameter alternate.  
Change into parametrizing mode with Set and do the line-compensation with Up/Down (enter value of line-resistance) or 3-wire ( $\exists-L$ ).

2-wire-configuration, compensation of cable-resistance:

Short-circuit the wires nearby the sensor and measure the resistance of the cable. Set „ $L-R$ “ to this value.

### Measuring Unit ( $^{\circ}C$ or $^{\circ}F$ ) at version for Pt 100-sensors (RTD):

Select menu item with Up/Down until display  $U_n, E$  and programmed unit alternate.  
Change into parametrizing mode with Set and select unit ( $^{\circ}C$  or  $^{\circ}F$ ).

### **Tips:**

- After finishing one menu item it is switched automatically to the next one.
- When the right decimal point in the 7 segment display is on, the display mode has been left, and the menu items can be chosen with up/down (menu mode).
- When the right decimal point blinks, you are in the parameter setting mode and can change the setting with up/down.
- Long pushing on up/down speeds up the changes in the display.
- Pushing button up and down at the same time sets values to zero.
- With reset (press set/reset for 2s) the display mode can be reached from every position of the parameter setting mode (the last selected value in is being stored).
- With  $I_{nLo}$  and  $I_{nHi}$  scaling is simplified when measuring-range and range of signal are different.

Example: Display 0-500.0 at input-signal 10-90 V:

- Connect to measuring input 100 V and select  $I_{nPU} = 100$
- Set  $I_{nLo}$  to 10.0
- Set  $I_{nHi}$  to 100.0
- Set  $d_{iLo}$  to 0
- Set  $d_{iHi}$  to 5000
- Set  $dP$  to 000.0

## Indication of the digital display:

I nPU	= measuring input / measuring range
500	= 500 V
100	= 100 V
50	= 50 V
10	= 10 V
300	= 300 mV
150	= 150 mV
0-20	= 0-20 mA
4-20	= 4-20 mA
I	= 1 A
ScAL	= scaling of measuring range and display
RUt0	= Zero, FullScale and decimal-point are taken over from selected measuring range
USEr	= scaling of measuring input and measuring range by the user
I nLo	= measuring range - Zero
I nHi	= measuring range - FullScale
d, Lo	= displayed value at measured signal = I nLo
d, Hi	= displayed value at measured signal = I nHi
dP	= decimal point
dd, S	= delay of display
F,	= fixed digits
Code	= code
Pin	= factory-setting of Pin = 504
on, oFF	= on / off
L-R	= line compensation
3-L	= 3-wire
Unit	= measuring unit for temperature Pt 100 (°C, °F)
----	= Min
=====	= Max
ErLo	= input current <3,8 mA at measuring range 4-20 mA
Er8, Er9	= error in device
-EEE	= signal lower than measuring range / display range
EEEE	= signal higher than measuring range / display range



## Factory-preset:

Reset to factory setting: Push button Set for 10 s when applying supply voltage until "----" is displayed.

Parameter	Version			Users own Data
	MINIPAN DC	MINIPAN AC	MINIPAN Pt 100	
I nPU	10	1	-	
L-A	-	-	3-L	
Unit	-	-	°C	
ScAL	AUto	AUto	-	
I nLo	0.00	0.000	-	
I nHi	10.00	1.000	-	
d, Lo	0	0	-	
d, Hi	5000	5000	-	
dP	0000.	0000.	-	
dd, S	0.5	0.5	0.5	
F, i	F, i	F, i	-	
CodE	oFF	oFF	oFF	
P, n	504	504	504	

## Operation

### DC- and AC-Meters

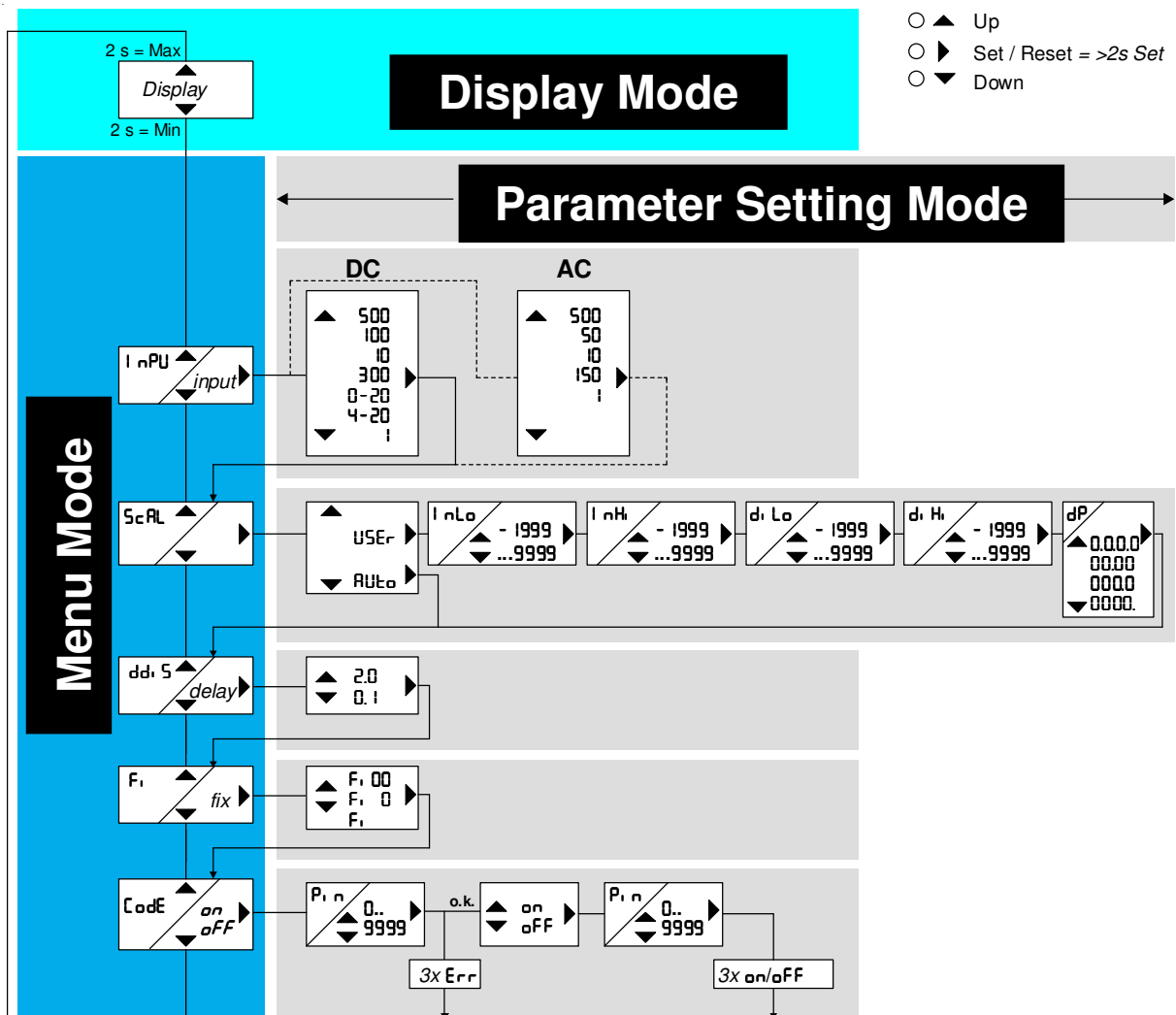

## Operation Pt 100- Meter

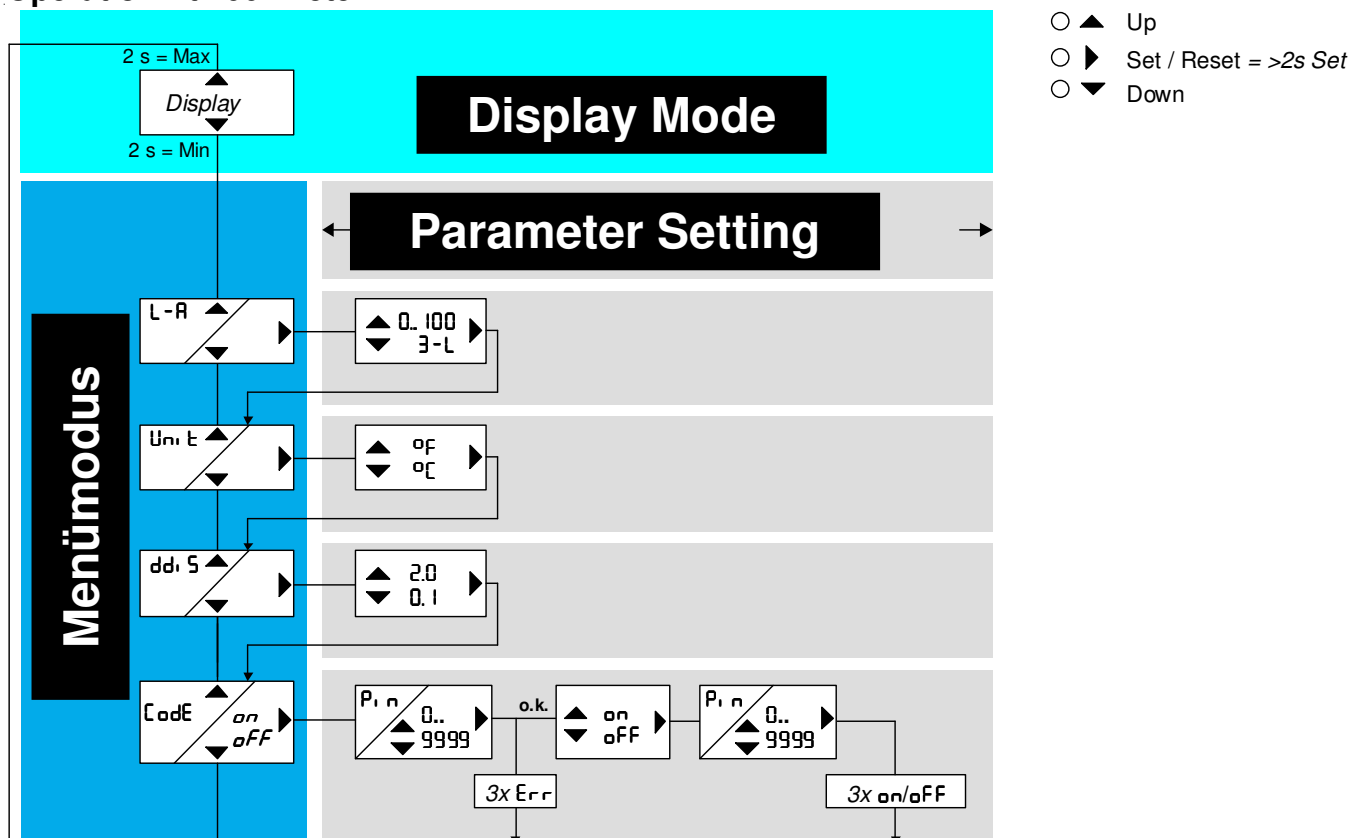

## Trouble shooting

- Unit cannot be programmed – Code lock**  
 The code lock gives protection against unauthorized manipulation of the unit. When code lock is activated the parameters can not be changed. The pin can be set by the user.  
 Pin unknown? Make code-reset: When switching in supply-voltage keep pushed button „Set“ for **2 s**.  
 Display indicates: "8888"; "CodE"; "oFF"; "8888" release button „Set“.  
 Code = oFF, Pin = 504.
- Indicated temperature does not correspond to the sensor temperature**
  - Is the correct measuring unit selected (°C or °F)?
  - Check programmed sensor-connection (2- or 3-wire, line-resistance).
- Displayed value wrong or no signal**  
 Check if the correct input is selected and if the signal is connected to the correct terminals. Check if terminals have been plugged correctly.
- Display „ErLo“**  
 input current <3,8 mA at measuring range 4-20 mA. Check lines for break.
- Display „Er8“ „Er9“**  
 Er8 and Er9 are internal errors (hardware / parameters). Switch off and on supply-voltage and reset parameters to factory-setting.  
 If the error still exists send it back to factory for repair.
- Display „-EEE“**  
 signal lower than measuring range / display range.
- Display „EEEE“**  
 signal higher than measuring range / display range.
- Display of software-version:** push Set for >10 s in display mode.

## Technical data

### Power Supply

Rated supply voltage Us	AC/DC 24-240 V
Tolerance DC	DC 20 - 297 V (0,85 x 24 V...1,35 x 220 V)
Tolerance AC	AC 20 - 264 V (0,85 x 24 V...1,1 x 240 V)
Power consumption	< 3 VA
Frequency	48...62 Hz

### Measuring Inputs

	insulated from supply-voltage (connect 1 input only)
<u>DC-Meter</u>	$\pm 300 \text{ mV}$ / 120 k $\Omega$ / max. $\pm 2,5 \text{ V}$
Measuring range / resistance of input	$\pm 10.00 \text{ V}$ / 1 M $\Omega$ / max. $\pm 50 \text{ V}$
/ overload capacity	$\pm 500.0 \text{ V}$ / 3 M $\Omega$ / max. $\pm 600 \text{ V}$ $\pm 100.0 \text{ V}$ / 3 M $\Omega$ / max. $\pm 600 \text{ V}$ $\pm 20.00 \text{ mA}$ / Shunt 15 $\Omega$ / max. $\pm 100$ $\pm 1.00 \text{ A}$ / Shunt 150 m $\Omega$ / max. $\pm 2 \text{ A}$
<u>AC-Meter</u>	$150 \text{ mV}$ / 900 $\Omega$ / max. 2,5 V
Measuring range / resistance of input	$10.00 \text{ V}$ / 100 k $\Omega$ / max. 50 V
/ overload capacity	$50.0 \text{ V}$ / 1 M $\Omega$ / max. 60 V $500.0 \text{ V}$ / 3 M $\Omega$ / max. 600 V $1.00 \text{ A}$ / Shunt 150 m $\Omega$ / max. 2 A
Measuring time AC/DC	< 400 ms + delay of display $\approx 5$
<u>Pt 100- Meter</u>	- $199,9 \dots + 850,0 \text{ }^\circ\text{C}$ (= -328 ... +1563 $^\circ\text{F}$ )
Sensor-connection	Pt 100, 2- or 3-wire
Wire-resistance 3-wire	max. 3 x 50 $\Omega$
Measuring time temperature	< 400 ms + delay of display $\approx 5$

### Accuracy

Resolution	+9999 / -1999
Error (of full measuring range)	
DC voltage and current	$\pm 0,1 \%$ $\pm 1$ Digit
AC voltage and current	$\pm 0,5 \%$ $\pm 1$ Digit
Temperature factor	$\pm 0,02 \%$ / Kelvin
Total error	
At Pt 100- Meter	$\pm 0,3 \%$ of value $\pm 0,5 \text{ K}$
Temperature factor	$\pm 0,03 \text{ }^\circ\text{C} / \text{K}$

### Test conditions

	EN 50178 / EN 61010-1
	EN 61326-1 industrial applications
Measuring category	CAT II 600 V DOUBLE INSULATION CAT III 300 V DOUBLE INSULATION
Contamination level	2
On-time	100 %
Rated ambient temperature range	-20 $^\circ\text{C}$ ... +60 $^\circ\text{C}$ EN 60068-2-1 dry heat
Vibration resistance EN 60068-2-6	2...25 Hz $\pm 1,6 \text{ mm}$ 25 ... 150 Hz 5 g

## Housing

Dimensions (h x w x d) mm  
Terminals  
Wire connection one wire  
Stranded with insulated ferrules  
Attachment Mounting

Panel-mount housing

36 x 72 x 79 mm

1 x 0,5...1,5 mm<sup>2</sup>

1 x 0,14...1 mm<sup>2</sup>

Panel-mount, panel cut-out 33<sup>+0,6</sup> x 68<sup>+0,7</sup> mm  
max. thickness of panel 8 mm

Protection housing

IP 30

Protection terminals

IP 20

Weight

approx. 120 g

Subject to technical changes

## Form

Dimensions in mm

Panel cut-out 33<sup>+0,6</sup> x 68<sup>+0,7</sup> mm

